

SURGICAL
INSTRUMENTS



THE ULTIMATE CHOICE

Hilton
PREMIUM STAINLESS STEEL



THE ULTIMATE CHOICE

DIAGNOSTIC

Diagnostic
Diagnostik
Diagnostica
ДИАГНОСТИКА
诊断

02

001 - 005

Percussion Hammers
 Perkussionshämmer
 Martillos de percusión
 Молотки
 敲击锤

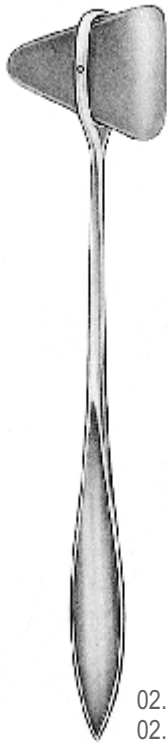

TAYLOR
 02.0010.18 18.0cm
 02.0010.20 20.0cm



DEJERINE
 02.0016.20 20.0cm



DEJERINE
 02.0022.21 21.0cm
 02.0022.35 35.0cm



NEURO-DUOFLEX
 02.0028.22 22.0cm

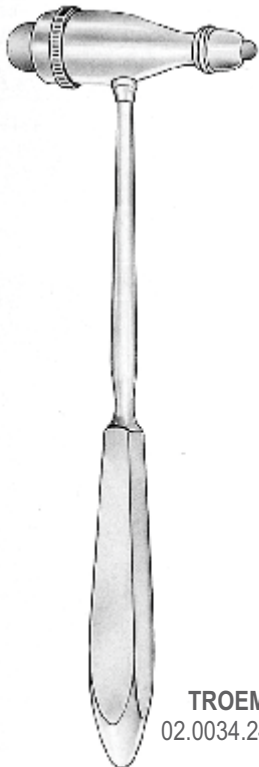

TROEMNER
 02.0034.24 24.0cm

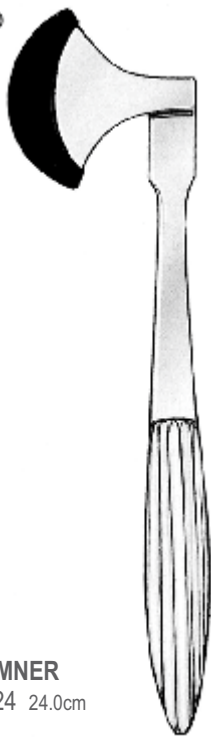

BERLINER
 02.0040.17 17.0cm
 02.0040.20 20.0cm



BUCK
 02.0046.18 18.0cm



BUCK (Telescopic)
 02.0052.18 18.0cm

DIAGNOSTIC



TRAUBE
02.0058.16 16.0cm



HURST
02.0064.20 20.0cm

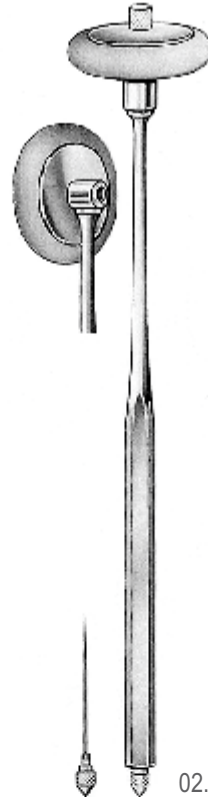

RABINER
02.0070.23 23.0cm

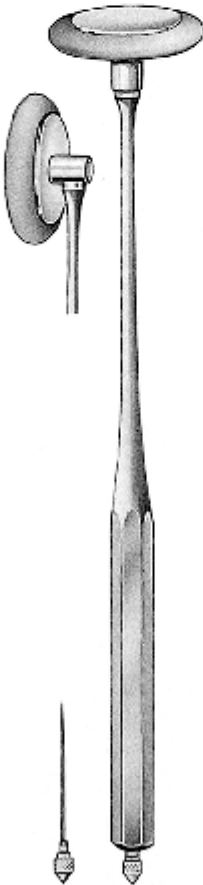

BABINSKY
02.0076.22 22.0cm
02.0076.25 25.0cm



NATIONAL HOSPITAL
35.0cm
02.0082.50 50mm Ø
02.0082.60 60mm Ø
02.0082.70 70mm Ø



QUEEN-SQUARE
02.0088.35 35.0cm

Stethoscopes, Sensibility and Measuring instruments

Stethoskope, Sensibilitäts und Meßinstrumente

Estetoscopios, Instrumentos para sensibilidad y para medidas

Стетоскопы, Инструменты для измерения чувствительности, Измерительные инструменты

听诊器, 感性和测量仪器



PINARD
02.0110.18 18.0cm
(wooden)



PINARD
02.0116.15 15.0cm
(plastic)



PINARD
02.0120.15 15.0cm
(aluminum)



PINARD
02.0122.15 15.0cm
(aluminum)

DIAGNOSTIC



WARTENBERG
02.0130.19 19.0cm



WEBER
02.0160.09 9.0cm



MOELTGEN
02.0170.23 23.0cm



02.0180.15 15.0cm
02.0180.30 30.0cm
02.0180.60 60.0cm



STETHOSCOPE
02.0190.00
double sided



STETHOSCOPE
02.0196.00
single sided



02.0200.00



ZIEGLER
02.0210.00



02.0220.00
Otoscope set in Case



02.0224.00
Otoscope set in Pouch



02.0230.00
Ophthalmoscope set



02.0240.00
Ophthalmoscope and Otoscope set



02.0250.00
Complete ENT set

DIAGNOSTIC



SURGICAL
INSTRUMENTS



THE ULTIMATE CHOICE

Hilton
PREMIUM STAINLESS STEEL



THE ULTIMATE CHOICE

TROCARS & SUCTION TUBES

Trocars and Suction Tubes
Trokare und Saugrohre
Trócares y tubos de aspiración
ТРОКАРЫ И ВСАСЫВАЮЩИЕ ТРУБКИ
套管针吸和管

06

001 - 017

Trocars
 Trokare
 Trócares
 Трокары
 套管针

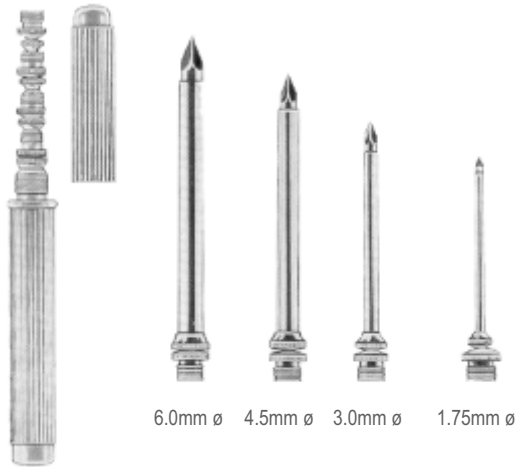

6.0mm Ø 4.5mm Ø 3.0mm Ø 1.75mm Ø

UNIVERSAL

06.0010.03 Set of 3 pieces
 06.0010.04 Set of 4 pieces



UNIVERSAL

06.0016.03 Set of 3 pieces
 06.0016.04 Set of 4 pieces

TROCARS & SUCTION TUBES



HYDROCELE

12.0cm
 06.0022.08 8 FG Ø
 06.0022.09 9 FG Ø
 06.0022.10 10 FG Ø



ASCITES

15.0cm
 06.0028.16 16 FG Ø
 06.0028.21 21 FG Ø



EXPLORING

06.0034.08 8 FG Ø

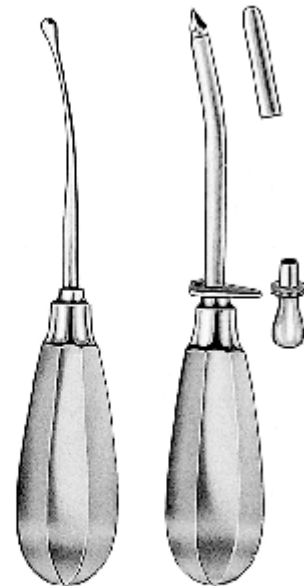

KRAUSE

06.0040.30 3.0mm Ø
 06.0040.40 4.0mm Ø
 06.0040.50 5.0mm Ø
 06.0040.55 5.5mm Ø

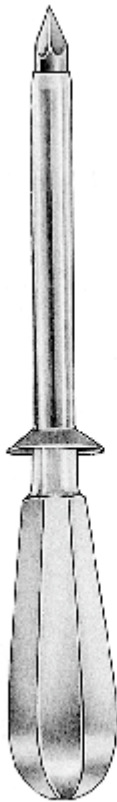

NELSON
21.0cm

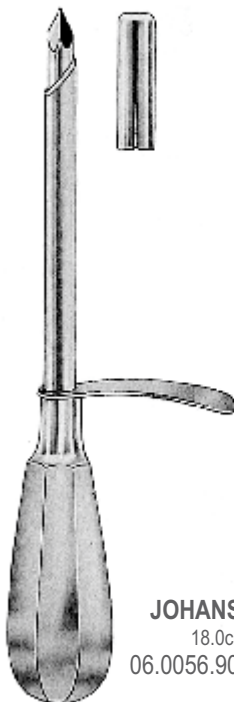

JOHANSSON
18.0cm
06.0056.90 9mm Ø



1
06.0048.25 25 FG



2
06.0048.30 30 FG

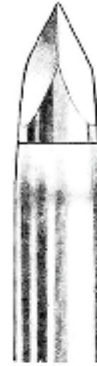

3
06.0048.33 33 FG



4
06.0048.35 35 FG



BILLROTH
24.0cm
06.0060.50 5mm Ø
06.0060.60 6mm Ø

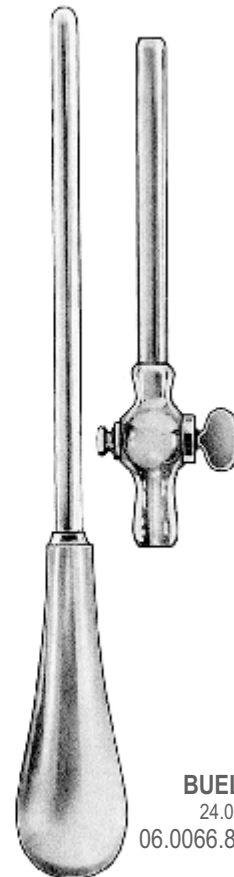
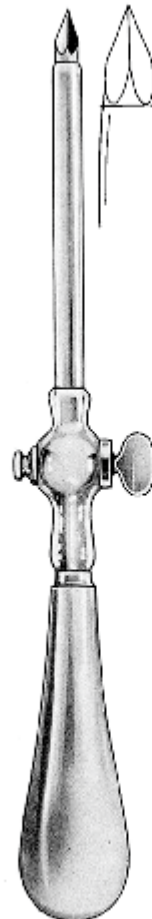

BUELAU
24.0cm
06.0066.80 8mm Ø

Trocars
 Trokare
 Trócares
 Трокары
 套管针



TROCARS & SUCTION TUBES



FLEURANT
 23.0cm
 06.0074.50 5mm Ø



FLEURANT
 23.0cm
 06.0080.50 5mm Ø



STANDARD 11.0cm
 06.0090.30 3.0mm Ø
 06.0090.35 3.5mm Ø
 06.0090.40 4.0mm Ø
 06.0090.45 4.5mm Ø
 06.0090.50 5.0mm Ø
 06.0090.55 5.5mm Ø
 06.0090.60 6.0mm Ø

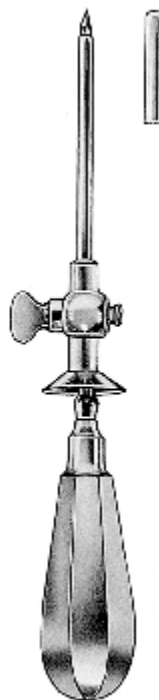

STANDARD 12.0cm
 06.0094.30 3.0mm Ø
 06.0094.35 3.5mm Ø
 06.0094.40 4.0mm Ø
 06.0094.45 4.5mm Ø
 06.0094.50 5.0mm Ø
 06.0094.55 5.5mm Ø
 06.0094.60 6.0mm Ø



STANDARD 12.0cm
 06.0098.30 3.0mm Ø
 06.0098.35 3.5mm Ø
 06.0098.40 4.0mm Ø
 06.0098.45 4.5mm Ø
 06.0098.50 5.0mm Ø
 06.0098.55 5.5mm Ø
 06.0098.60 6.0mm Ø

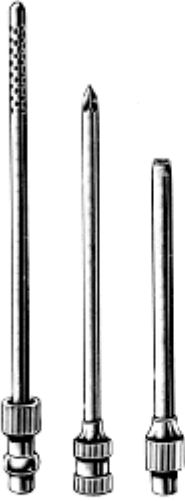

DUKE
11.0cm
06.0104.55 5.5mm Ø



BIRCH
18.0cm
06.0108.45 4.5mm Ø



OCHSNER
06.0110.10 10 FG Ø
06.0110.12 12 FG Ø
06.0110.14 14 FG Ø
06.0110.16 16 FG Ø
06.0110.18 18 FG Ø
06.0110.20 20 FG Ø
06.0110.22 22 FG Ø



OCHSNER
06.0112.10 10 FG Ø
06.0112.12 12 FG Ø
06.0112.14 14 FG Ø
06.0112.16 16 FG Ø
06.0112.18 18 FG Ø
06.0112.20 20 FG Ø
06.0112.22 22 FG Ø



PIERCE
06.0128.30 3.0mm Ø
06.0128.40 4.0mm Ø
06.0128.50 5.0mm Ø



LANDAU
06.0134.20 2.0mm Ø

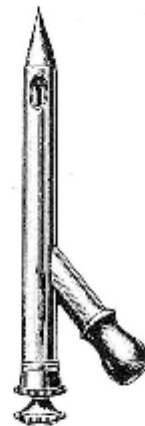

PEAN
06.0140.13 13.5mm Ø

Trocars
 Trokare
 Trócares
 Трокары
 套管针



RUSKIN

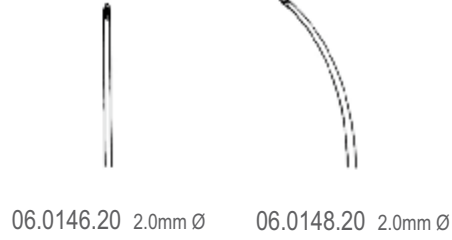

06.0146.20 2.0mm Ø 06.0148.20 2.0mm Ø

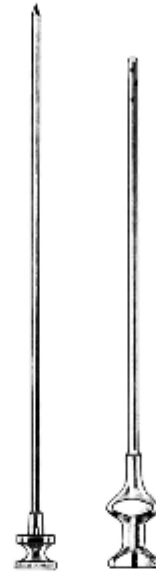

EICKEN

10.5cm

06.0156.18 1.8mm Ø
 06.0156.20 2.0mm Ø
 06.0156.30 3.0mm Ø



DOUGLAS

06.0162.30 3.0mm Ø

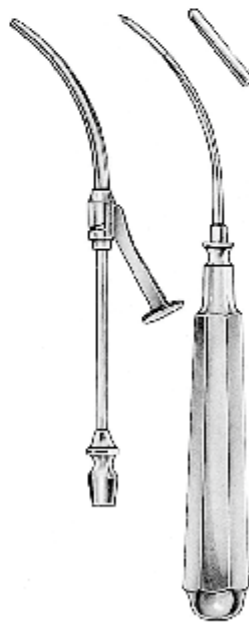

COAKLEY

06.0166.22 2.25mm Ø



LICHTWITZ

06.0170.12 1.25mm Ø
 06.0170.15 1.50mm Ø
 06.0170.18 1.80mm Ø

TROCARS & SUCTION TUBES



SCHMID



06.0176.30 3.0mm Ø



06.0176.40 4.0mm Ø



06.0176.50 5.0mm Ø



06.0176.60 6.0mm Ø



IOWA
06.0182.14 14.0cm



- 8 FG 06.0190.08
- 10 FG 06.0190.10
- 12 FG 06.0190.12
- 14 FG 06.0190.14
- 16 FG 06.0190.16
- 18 FG 06.0190.18



- 06.0192.08
- 06.0192.10
- 06.0192.12
- 06.0192.14
- 06.0192.16
- 06.0192.18



- 06.0194.08
- 06.0194.10
- 06.0194.12
- 06.0194.14
- 06.0194.16
- 06.0194.18



- VERRES
- 06.0202.55 1.5 x 55mm Ø
 - 06.0202.10 2.0 x 100mm Ø
 - 06.0202.12 2.0 x 120mm Ø
 - 06.0202.15 2.0 x 150mm Ø

Suction Tubes
 Saugrohre
 Tubos de aspiración
 Всасывающие трубки
 吸引管



TROCARS & SUCTION TUBES



FERGUSSON

	11.0cm	13.0cm	16.0cm	18.0cm	20.0cm
1.5mm Ø	06.0210.15	06.0212.15	06.0214.15	06.0216.15	06.0218.15
2.0mm Ø	06.0210.20	06.0212.20	06.0214.20	06.0216.20	06.0218.20
2.5mm Ø	06.0210.25	06.0212.25	06.0214.25	06.0216.25	06.0218.25
3.0mm Ø	06.0210.30	06.0212.30	06.0214.30	06.0216.30	06.0218.30
4.0mm Ø	06.0210.40	06.0212.40	06.0214.40	06.0216.40	06.0218.40
5.0mm Ø	06.0210.50	06.0212.50	06.0214.50	06.0216.50	06.0218.50



FERGUSSON

06.0222.05	05 FG
06.0222.06	06 FG
06.0222.07	07 FG
06.0222.08	08 FG
06.0222.09	09 FG
06.0222.10	10 FG
06.0222.12	12 FG



POP PEN

	13.0cm
06.0228.06	06 FG
06.0228.08	08 FG
06.0228.10	10 FG
06.0228.12	12 FG



POP PEN

	13.0cm
06.0234.08	08 FG
06.0234.10	10 FG



FRAZIER

Charr.	19.0cm	
FG	30°	75°
06	06.0240.06	06.0242.06
07	06.0240.07	06.0242.07
08	06.0240.08	06.0242.08
09	06.0240.09	06.0242.09
10	06.0240.10	06.0242.10
11	06.0240.11	06.0242.11
12	06.0240.12	06.0242.12



FRAZIER

	19.0cm
06.0246.08	08 FG
06.0246.10	10 FG



PLESTER
19.5cm
06.0252.15 1.5mm Ø
06.0252.20 2.0mm Ø
06.0252.25 2.5mm Ø
06.0252.30 3.0mm Ø



ADSON
16.5cm
06.0258.80 3mm Ø
Olive
8mm Ø



ADSON
21.0cm
06.0266.40 4mm Ø



LEMPERT
20.0cm
06.0272.20 2.0mm Ø
06.0272.30 3.0mm Ø
Olive
7 - 9mm Ø



BARRON
16.0cm
06.0278.13 1.3mm Ø
06.0278.20 2.0mm Ø



SCHUHKNECHT
13.0cm
06.0284.05 0.5mm Ø
06.0284.10 1.0mm Ø
06.0284.20 2.0mm Ø
06.0284.30 3.0mm Ø



WULLSTEIN (set)
06.0290.00 14.0cm



06.0290.04



06.0290.06



06.0290.08

ZOELLNER (each 10 Pieces)

- 06.0302.04 0.4mm Ø
- 06.0302.05 0.5mm Ø
- 06.0302.07 0.7mm Ø
- 06.0302.10 1.0mm Ø
- 06.0302.12 1.2mm Ø



ZOELLNER

- 18.0cm
- 06.0300.00 (Set)
- 06.0300.01 (Cannula only 2.5mm Ø)
- (Complete consists of suction cannula and detachable ends 06.0302.04 to 06.0302.12)



BELLUCCI

- 15.0cm
- 06.0310.00 (Set)
- 06.0310.01 (Cannula only)
- (Complete consists of suction cannula and detachable ends 06.0302.05, 06.0302.07 & 06.0302.10)



- 06.0316.20 2.0mm Ø
- 06.0316.25 2.5mm Ø
- 06.0316.30 3.0mm Ø
- (90° to curve with LUER hub)

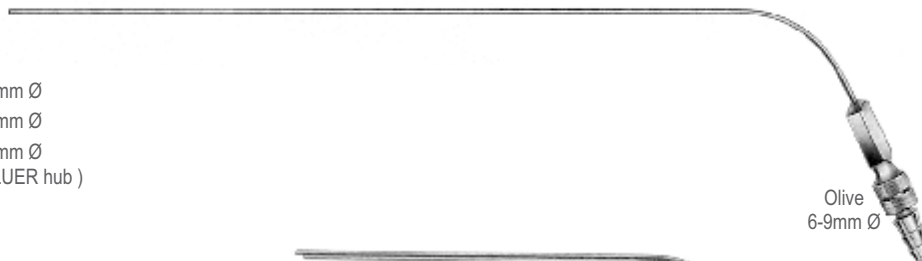

HOUSE

- 06.0322.09 0.9mm Ø , 0.7mm Ø
- 06.0322.12 1.2mm Ø , 0.9mm Ø
- 06.0322.15 1.5mm Ø , 1.2mm Ø

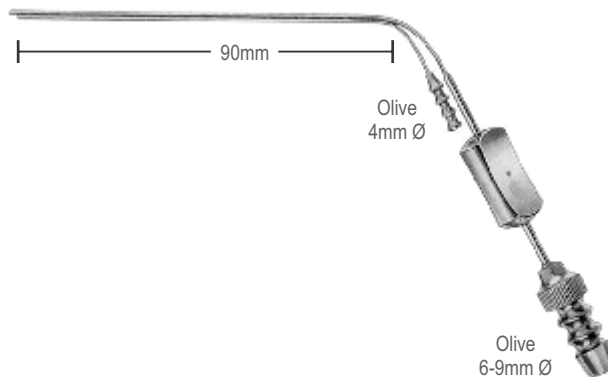



YASARGIL

Length	1.5mm Ø	2.0mm Ø	2.5mm Ø	3.5mm Ø
13.0cm	06.0380.13	06.0384.13	06.0388.13	06.0392.13
15.0cm	06.0380.15	06.0384.15	06.0388.15	06.0392.15
18.0cm	06.0380.18	06.0384.18	06.0388.18	06.0392.18
22.0cm	06.0380.22	06.0384.22	06.0388.22	06.0392.22

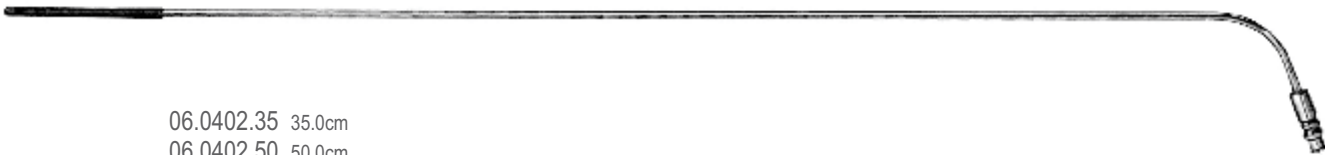

06.0402.35 35.0cm
06.0402.50 50.0cm
(With Rubber Tip)

MAGILL

06.0408.30	3.0mm Ø
06.0408.35	3.5mm Ø
06.0408.40	4.0mm Ø
06.0408.45	4.5mm Ø



06.0408.01 Stilette for MAGILL suction tubes

Suction Tubes
 Saugrohre
 Tubos de aspiración
 Всасывающие трубки
 吸引管



BABY POOLE
 20.0cm
 06.0420.55 5.5mm Ø

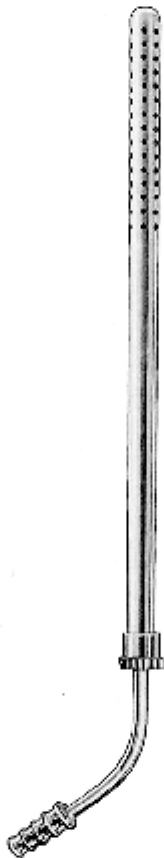

POOLE
 22.0cm
 06.0422.08 8mm Ø
 06.0422.10 10mm Ø



POOLE
 22.0cm
 06.0424.08 8mm Ø
 06.0424.10 10mm Ø



LAWRIE
 18.0cm
 06.0430.18
 Extension Piece

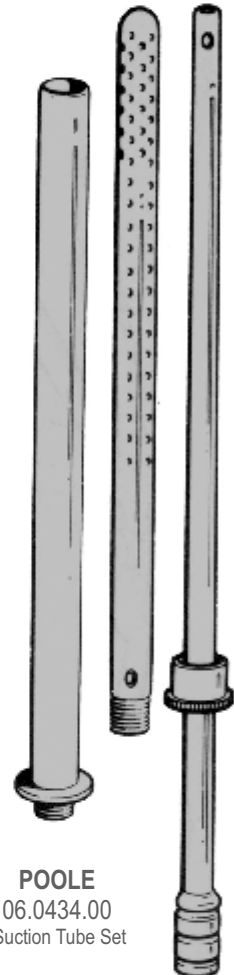

POOLE
 06.0434.00
 Suction Tube Set

TROCARS & SUCTION TUBES



COOLEY
30.0cm
06.0440.30 7mm Ø



COOLEY
31.0cm
06.0442.31 10mm Ø



COOLEY
33.0cm
06.0444.33 8mm Ø



COOLEY
35.0cm
06.0446.35 8mm Ø

Suction Tubes
 Saugrohre
 Tubos de aspiración
 Всасывающие трубки
 吸引管



TROCARS & SUCTION TUBES

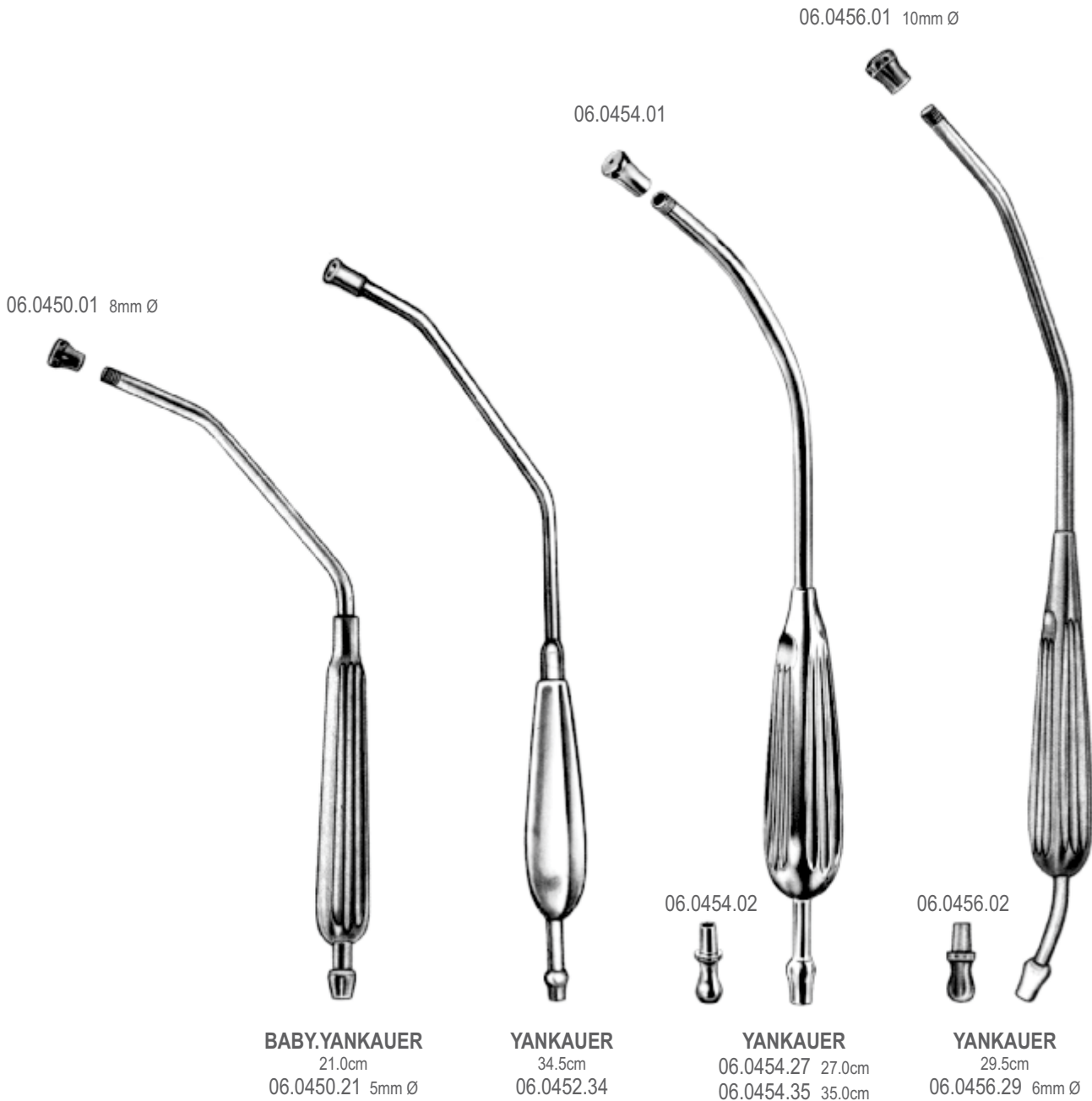

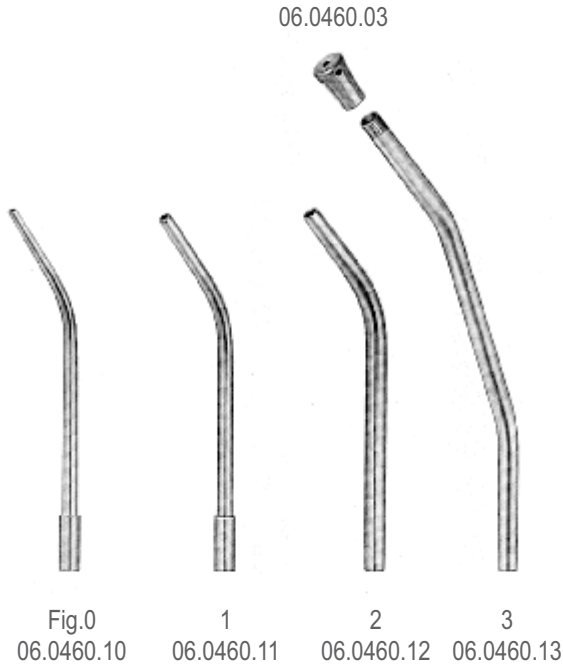

YANKAUER
27.0cm
06.0460.27 set



BYRD
06.0470.15 1.5mm Ø
06.0470.25 2.5mm Ø
06.0470.35 3.5mm Ø



COGSWELL
23.0cm
06.0474.23 2.0mm Ø

Suction Tubes
 Saugrohre
 Tubos de aspiración
 Всасывающие трубки
 吸引管

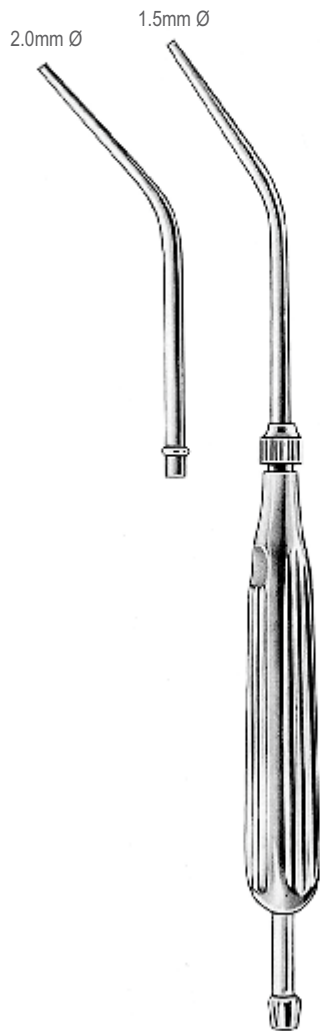

COUPLAND
 06.0480.00 set

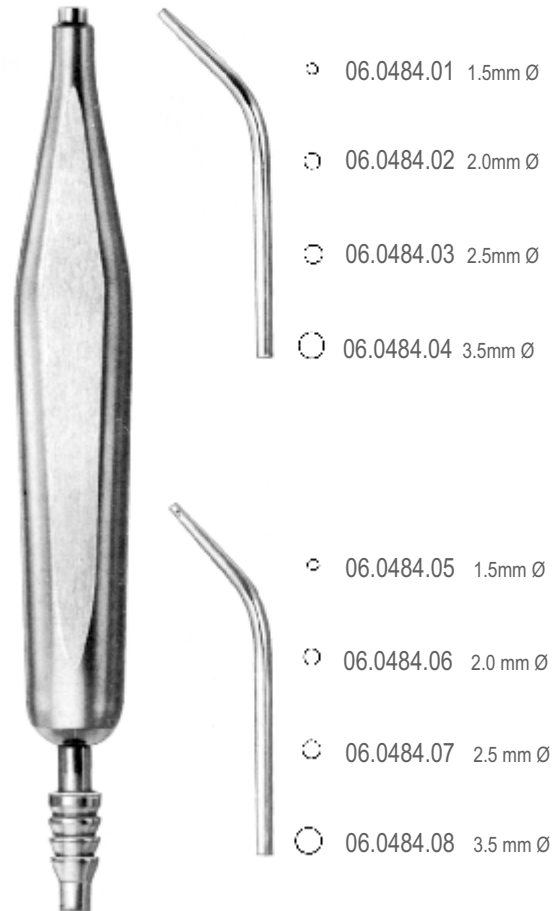

COUPLAND
 17.0cm
 06.0484.17 set

TROCARS & SUCTION TUBES

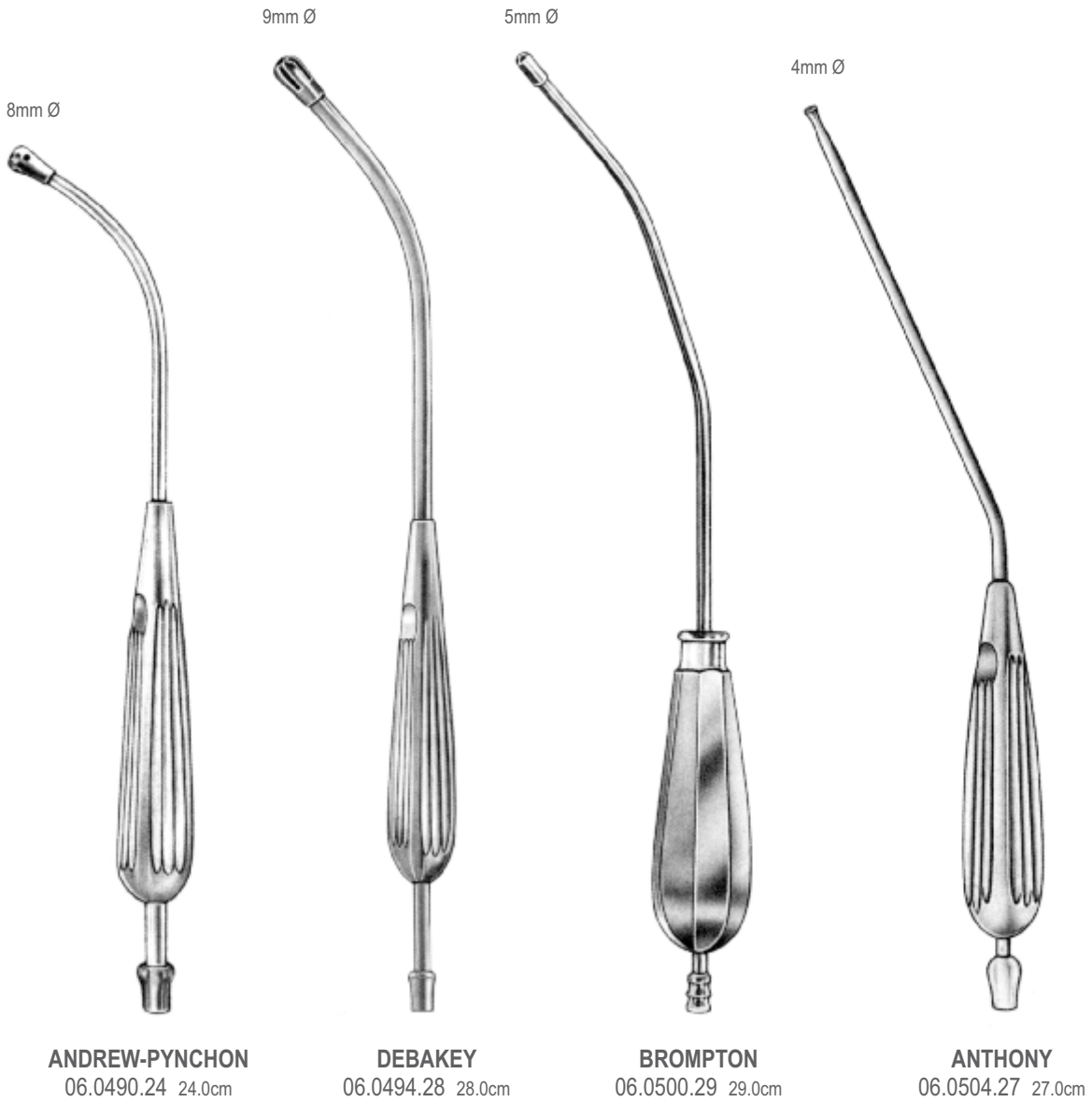

Suction Tubes
Saugrohre
Tubos de aspiración
Всасывающие трубки
吸引管

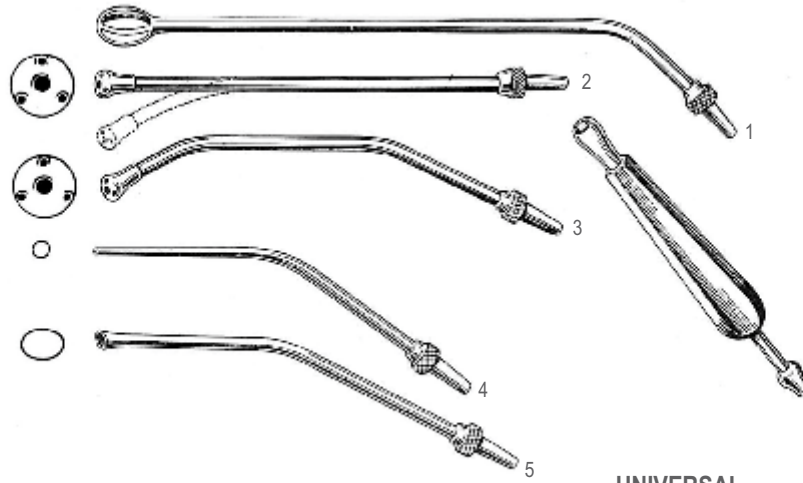

UNIVERSAL
06.0510.00 (Set)

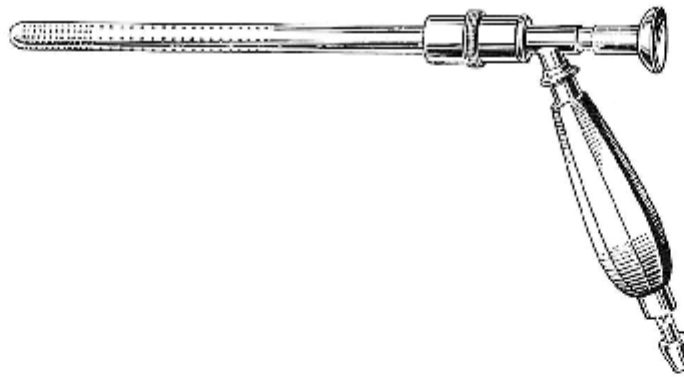

SIMPSON-SMITH
06.0514.00 (Complete)

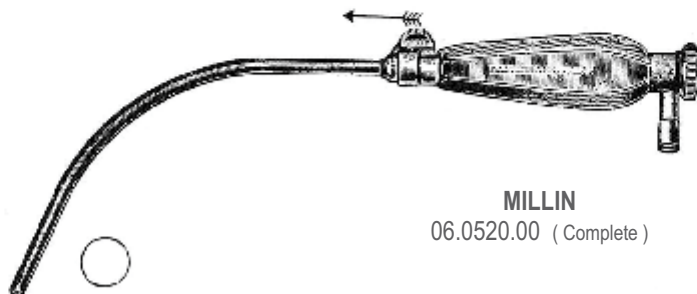

MILLIN
06.0520.00 (Complete)

TROCARS & SUCTION TUBES



SURGICAL
INSTRUMENTS



THE ULTIMATE CHOICE

Hilton
PREMIUM STAINLESS STEEL



THE ULTIMATE CHOICE

SCALPELS

Scalpels
Skalpelle
Bisturies
СКАЛЬПЕЛИ
手术刀

08

001 - 008

Dissecting knives
Anatomische skalpelle
Bisturies para disección
Скальпели хирургические
解剖刀



Fig.1
08.0010.01



2
08.0010.02



3
08.0010.03



4
08.0010.04



5
08.0010.05



6
08.0010.06



7
08.0010.07



8
08.0010.08



9
08.0010.09



10
08.0010.10

SCALPELS

SCALPELS



08.0016.01

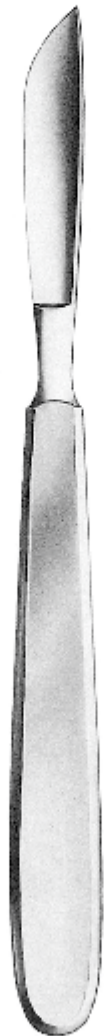

COLLIN



1
08.0020.01



2
08.0020.02



3
08.0020.03



4
08.0020.04



5
08.0020.05



6
08.0020.06



1
08.0026.01



2
08.0026.02

Autopsy knives, Cartilage knives, Post Mortem knives
 Seziermesser, knorpelmesser, Organmesser
 Cuchillos para autopsia, cuchillos para cartilago, cuchillos para órganos
 Ножи анатомические, Ножи хрящевые, Ножи для вскрытия
 尸检刀, 刀软骨, 验尸刀



SCALPELS

08.0030.10 25.5cm
 Blade size 100mm

WALB
 08.0036.11 26.0cm
 Blade size 110mm

08.0036.14 29.0cm
 Blade size 140mm

08.0036.17 31.0cm
 Blade size 170mm

VIRCHOW
 08.0042.01

VIRCHOW
 08.0048.01

VIRCHOW
 08.0054.08 21.0cm
 Blade size 80mm

VIRCHOW
 08.0060.16 26.0cm
 Blade size 160mm

08.0060.20 33.5cm
 Blade size 200mm

08.0060.24 38.0cm
 Blade size 240mm

SCALPELS



STANDARD
08.0100.03 #3

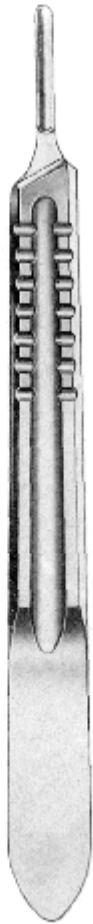

08.0104.03 #3



08.0108.03 #3

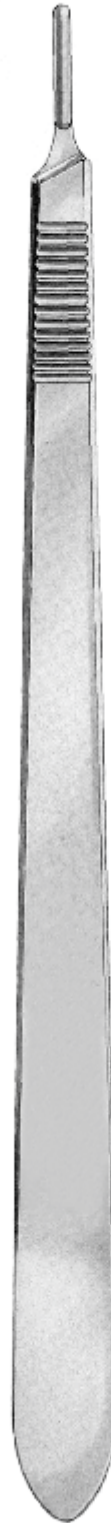

08.0112.20 #3L
08.0112.35 #3XL

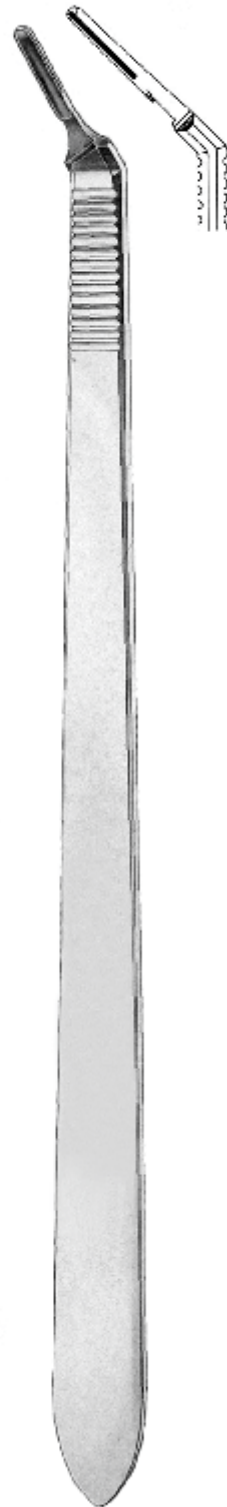

08.0116.20 #3L
08.0116.35 #3XL
angled

Scalpel Handles
 Skalpelli griffe
 Mangos de bisturí
 Держатели для лезвий
 手术刀把手



STANDARD
 08.0120.04 #4

08.0124.20 #4L
 08.0124.35 #4XL

08.0128.20 #4L
 08.0128.35 #4XL
 angled

08.0132.07 #7 08.0136.07 #7K

COLLIN
 08.0140.08

SCALPELS

SCALPELS



COLLIN
08.0148.13 13.0cm
08.0148.16 16.0cm
08.0148.19 19.0cm
08.0148.22 22.0cm
08.0148.28 28.0cm



CATLIN
08.0154.11 11.0cm
08.0154.16 16.0cm
08.0154.19 19.0cm
08.0154.22 22.0cm



LISTON
08.0160.17 17.0cm
08.0160.20 20.0cm



LANGENBECK
08.0164.12 12.0cm



08.0170.09 9.5cm

Razor knives and blade breakers
 Rasiermesser und klingen brecher
 Navajas y Pinzas para romper hojas
 Ножи бритвенные, Держатели для лезвий
 剃刀和刀片破碎机



08.0250.01

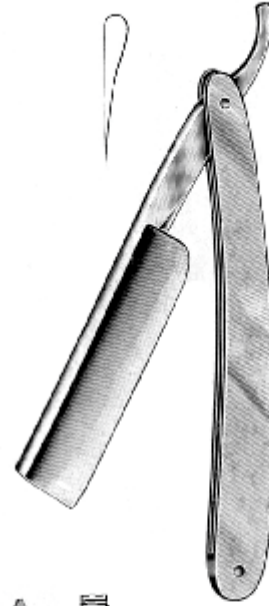

08.0250.02



TROUTMAN-CHRIS
 10.0cm
 08.0270.10 5.5mm Ø



TROUTMAN-CHRIS
 10.0cm
 08.0276.10 5.5mm Ø

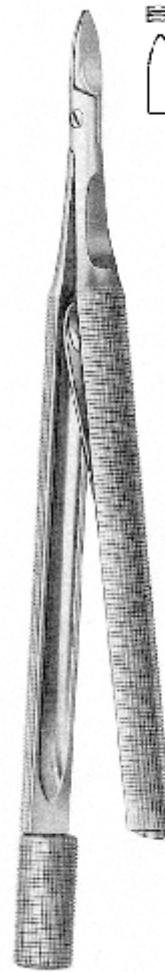

CASTROVIEJO
 13.0cm
 08.0284.13 8mm Ø

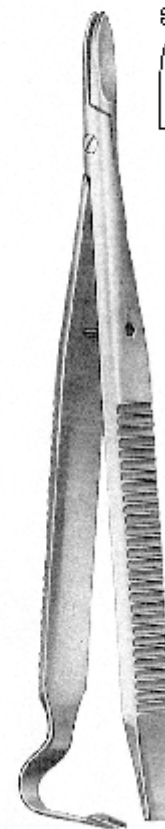

08.0290.11
 11.0cm

SCALPELS

SCALPELS



SCHINK
30.0cm
08.0330.00



08.0330.01

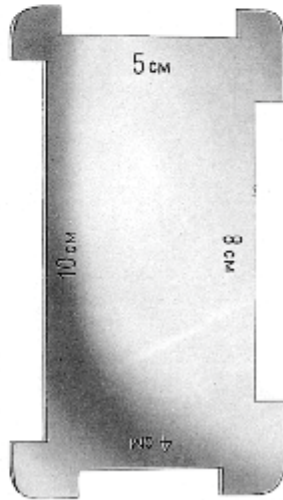

08.0330.02



HUMBY
31.0cm
08.0350.00



08.0350.01



SURGICAL
INSTRUMENTS



THE ULTIMATE CHOICE

Hilton
PREMIUM STAINLESS STEEL

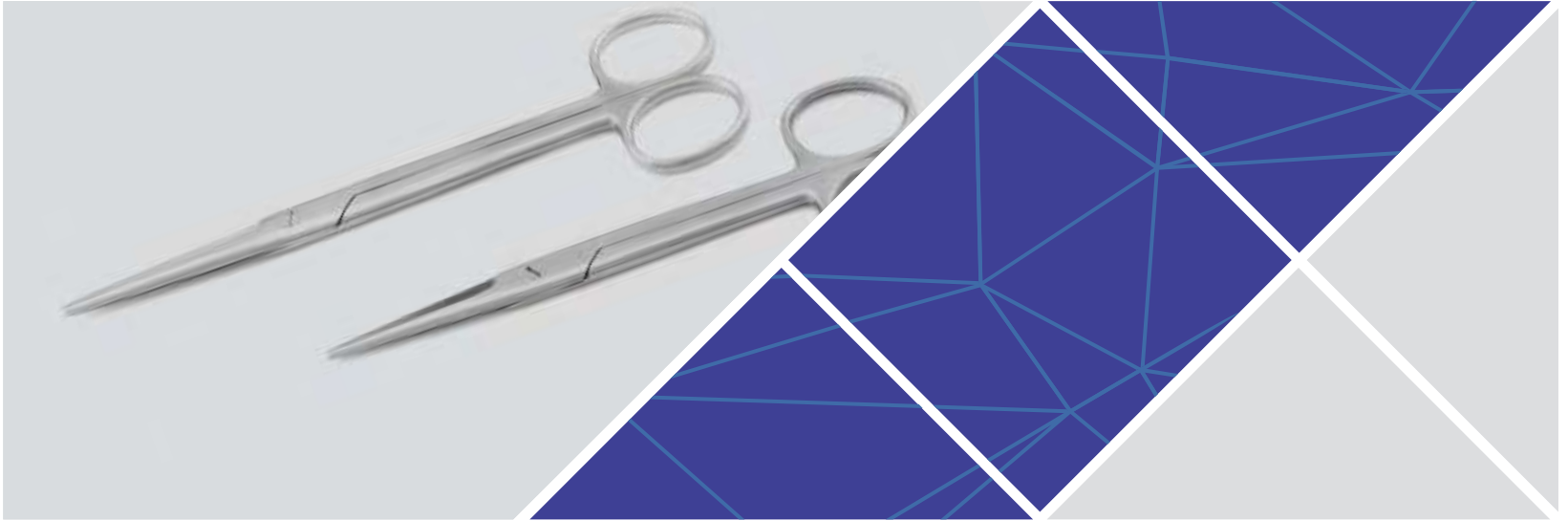

THE ULTIMATE CHOICE

SCISSORS

Scissors
Scheren
Tijeras
НОЖНИЦЫ
剪刀

10

001 - 024

Operating Scissors
 Chirurgische Scheren
 Tijeras para cirugía
 Ножницы операционные
 操作剪刀

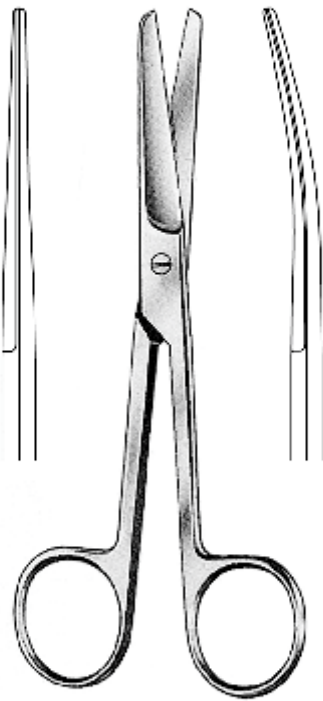

STANDARD

10.5cm	10.0010.10	10.0011.10
11.5cm	10.0010.11	10.0011.11
13.0cm	10.0010.13	10.0011.13
14.5cm	10.0010.14	10.0011.14
15.5cm	10.0010.15	10.0011.15
16.5cm	10.0010.16	10.0011.16
18.5cm	10.0010.18	10.0011.18
20.0cm	10.0010.20	10.0011.20

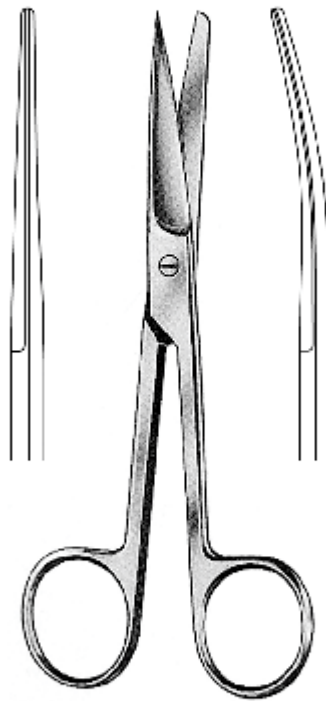

STANDARD

10.0012.10	10.0013.10
10.0012.11	10.0013.11
10.0012.13	10.0013.13
10.0012.14	10.0013.14
10.0012.15	10.0013.15
10.0012.16	10.0013.16
10.0012.18	10.0013.18
10.0012.20	10.0013.20

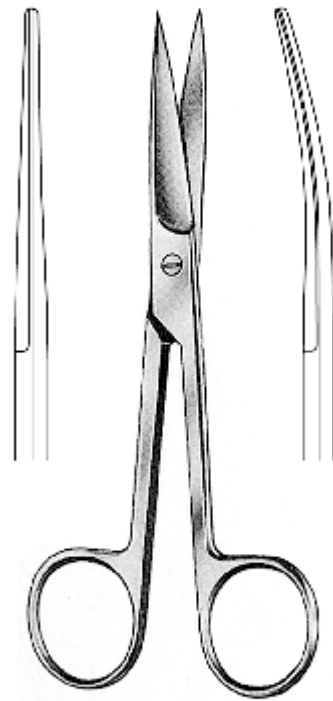

STANDARD

10.0014.10	10.0015.10
10.0014.11	10.0015.11
10.0014.13	10.0015.13
10.0014.14	10.0015.14
10.0014.15	10.0015.15
10.0014.16	10.0015.16
10.0014.18	10.0015.18
10.0014.20	10.0015.20

SCISSORS

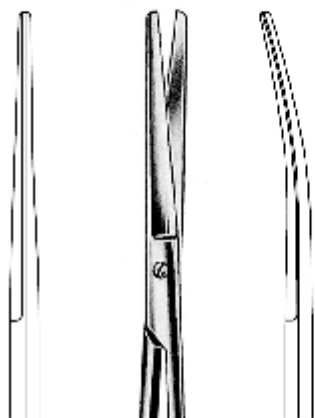

GRAZIL

10.0022.13 13.0cm 10.0023.13
10.0022.14 14.0cm 10.0023.14

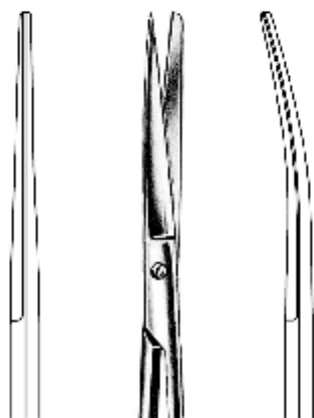

GRAZIL

10.0024.13 13.0cm 10.0025.13
10.0024.14 14.0cm 10.0025.14

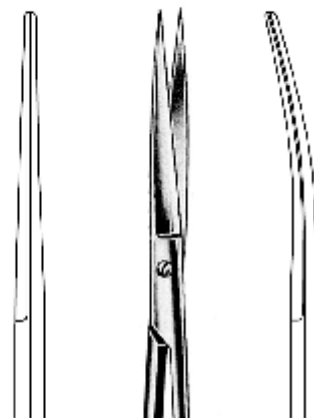

GRAZIL

10.0026.13 13.0cm 10.0027.13
10.0026.14 14.0cm 10.0027.14

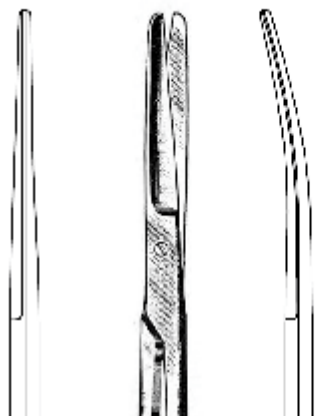

DEAVER

10.0034.14 14.0cm 10.0035.14

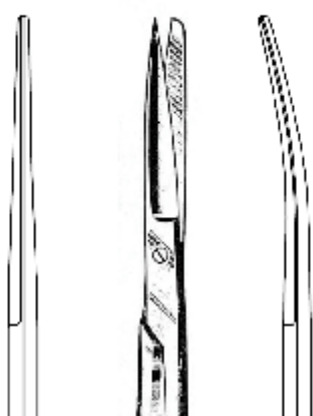

DEAVER

10.0036.14 14.0cm 10.0037.14

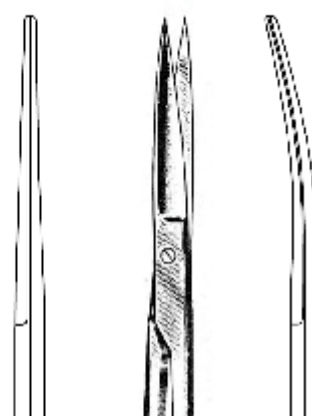

DEAVER

10.0038.14 14.0cm 10.0039.14



10.0046.13 13.0cm
 10.0046.14 14.0cm

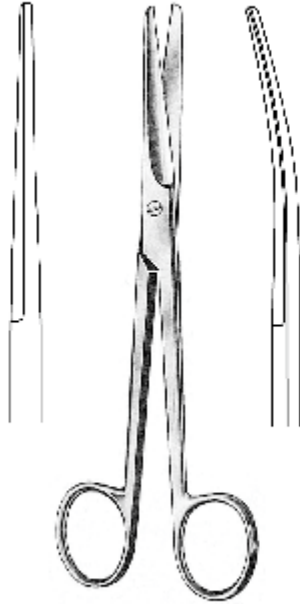

MAYO

10.0052.14 14.0cm 10.0053.14
 10.0052.15 15.0cm 10.0053.15
 10.0052.16 16.0cm 10.0053.16
 10.0052.17 17.0cm 10.0053.17
 10.0052.18 18.0cm 10.0053.18
 10.0052.19 19.0cm 10.0053.19
 10.0052.23 23.0cm 10.0053.23

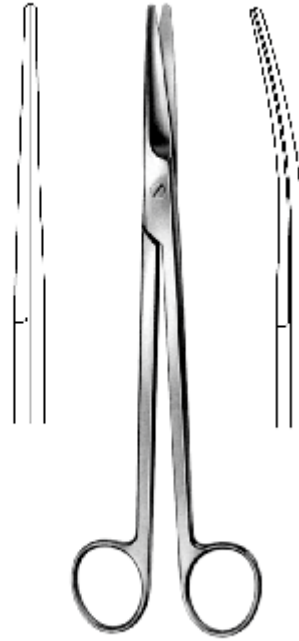

MAYO-HARRINGTON

10.0058.22 22.5cm 10.0059.22
 10.0058.30 30.0cm 10.0059.30

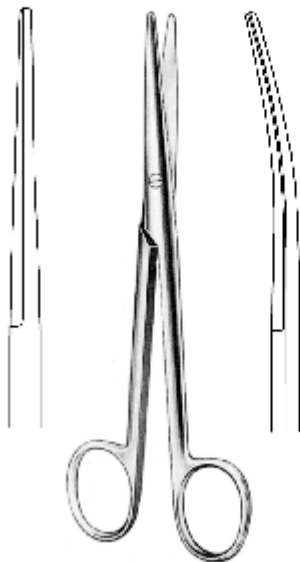

MAYO-STILLE

10.0064.16 16.0cm 10.0065.16
 10.0064.19 19.0cm 10.0065.19
 10.0064.21 21.0cm 10.0065.21

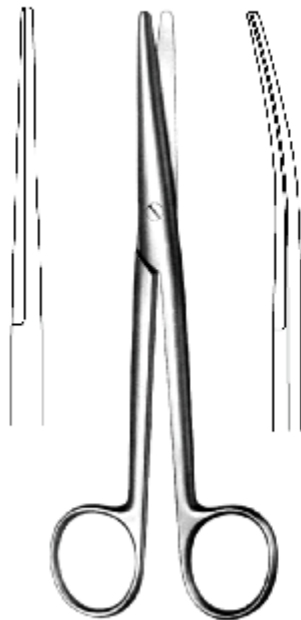

MAYO-STILLE

10.0068.15 15.0cm 10.0069.15
 10.0068.17 17.0cm 10.0069.17
 10.0068.21 21.0cm 10.0069.21

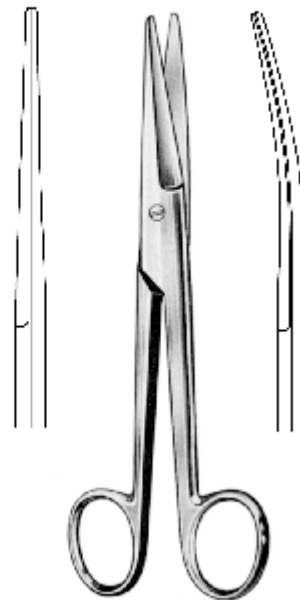

MAYO-NOBLE

10.0072.17 17.0cm 10.0073.17

SCISSORS

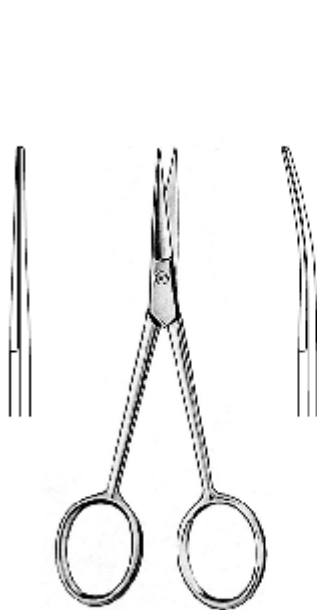

10.0092.11 11.0cm 10.0093.11
10.0092.12 12.0cm 10.0093.12
10.0092.14 14.0cm 10.0093.14

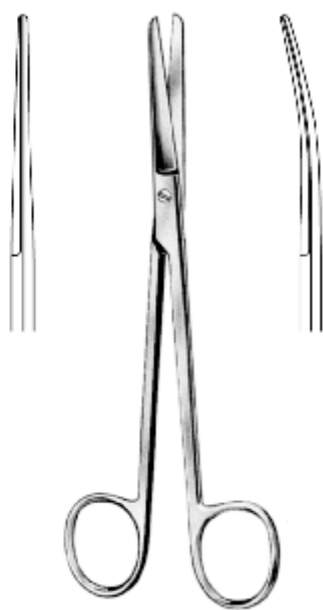

MIXTER
10.0100.15 15.0cm 10.0101.15

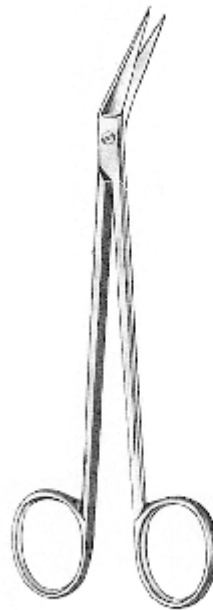

10.0116.16 16.0cm



LOCKLIN
10.0118.16 16.0cm



QUINBY
10.0120.12 12.5cm



NEUMANN
10.0124.12 12.0cm

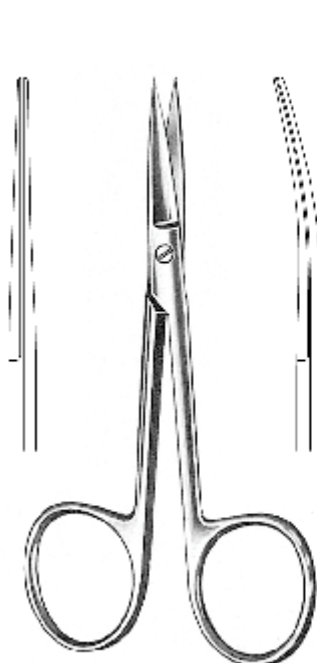

WAGNER
10.0130.12 12.0cm 10.0131.12

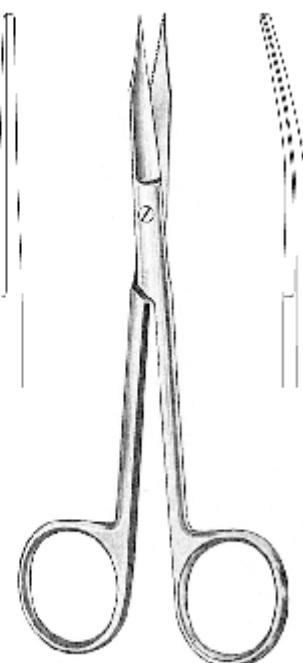

GOLDMAN-FOX
10.0136.13 13.0cm 10.0137.13

Fine Operating Scissors, Strabismus Scissors
 Fine Chirurgische Scheren, Strabismusscheren
 Tijers finas para cirugia, estrbismo
 Ножницы тонкие операционные
 微操作剪刀, 剪刀斜视

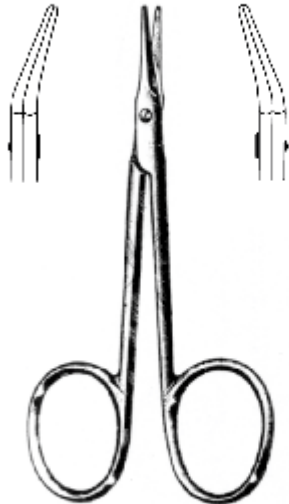

AEBLI
 10.0140.09 9.0cm 10.0141.09

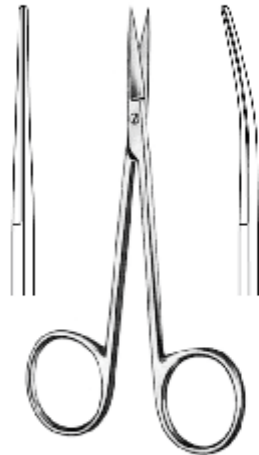

IRIS
 10.0142.09 9.0cm 10.0143.09
 10.0142.10 10.5cm 10.0143.10



IRIS
 10.0144.11 11.5cm 10.0145.11

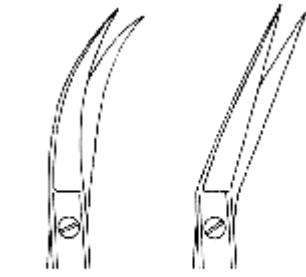

10.0147.11 10.0149.11

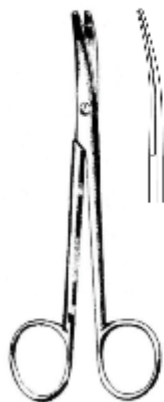

10.0154.11 11.0cm

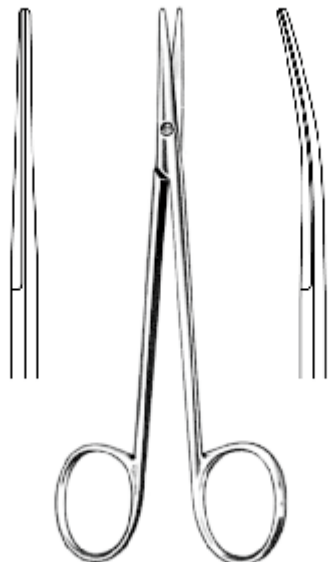

STRABISMUS
 10.0160.11 11.5cm 10.0161.11



STEVENS

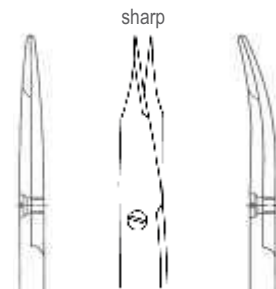

10.0166.11 11.0cm 10.0167.11

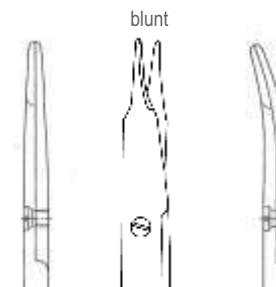

10.0168.11 11.0cm 10.0169.11

SCISSORS

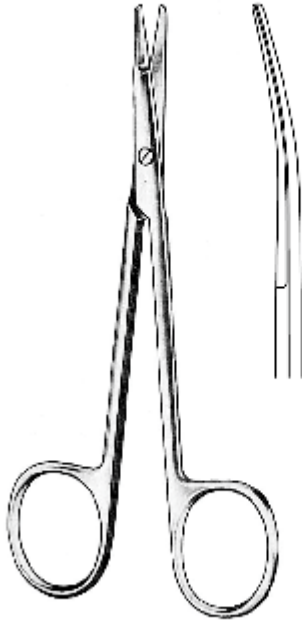

KILNER

10.0174.12 12.0cm
 10.0174.15 15.0cm

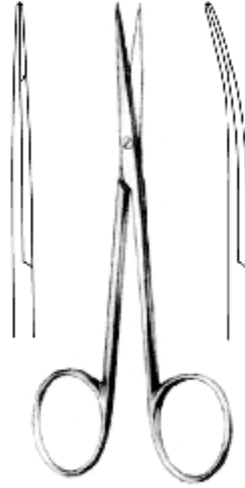

10.0178.11 11.0cm 10.0179.11

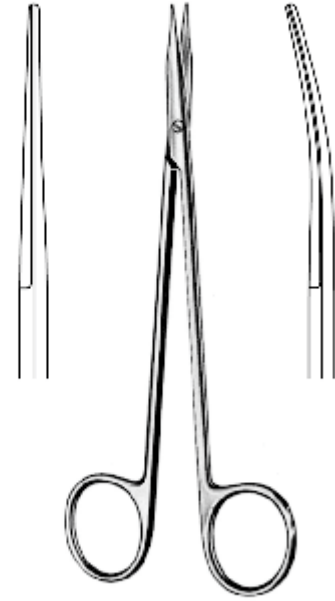

REYNOLDS

10.0184.15 15.0cm 10.0185.15
 10.0184.18 18.0cm 10.0185.18



SANVENERO

10.0190.14 14.0cm 10.0191.14



JOSEPH

10.0196.14 14.0cm 10.0197.14

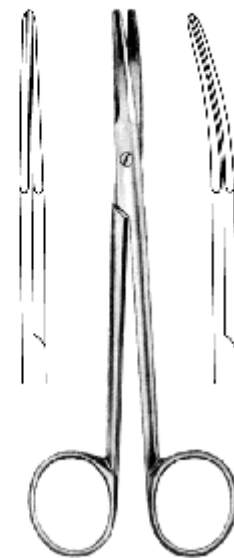

AUFRICHT

10.0200.14 14.5cm 10.0201.14

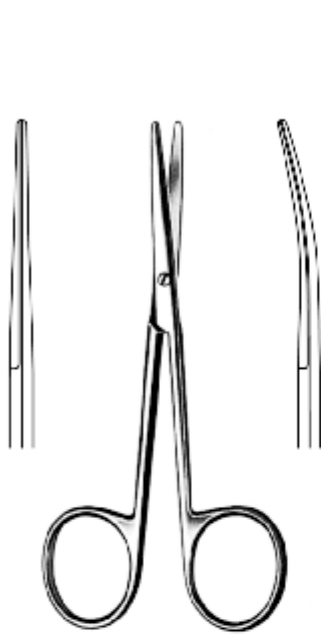

LEXER-BABY
 10.0300.10 10.0cm 10.0301.10

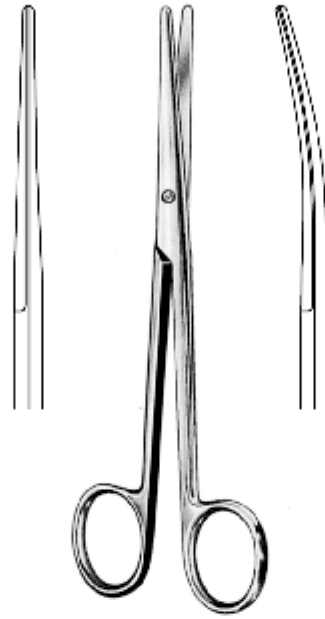

LEXER
 10.0306.16 16.0cm 10.0307.16
 10.0306.21 21.0cm 10.0307.21

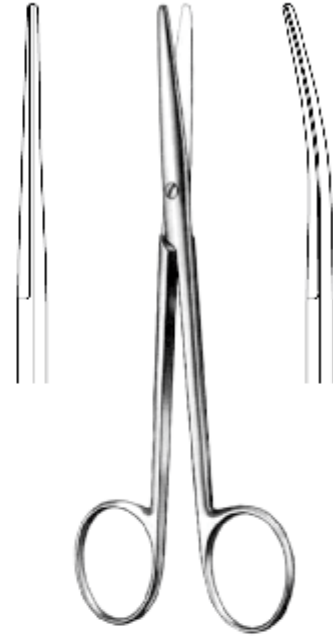

LEXER-FINO
 10.0310.16 16.0cm 10.0311.16

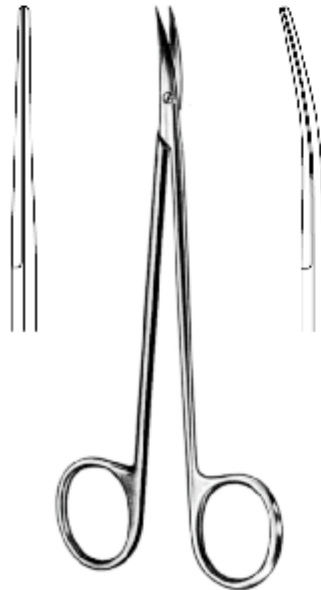

NERVE-PREPARATION
 10.0316.15 15.0cm 10.0317.15

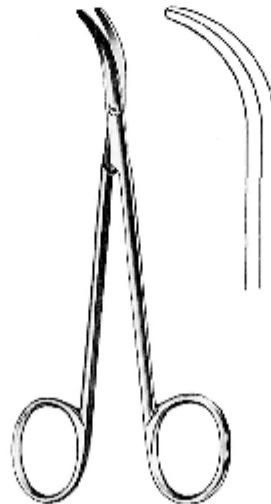

FOMON
 10.0320.13 13.5cm

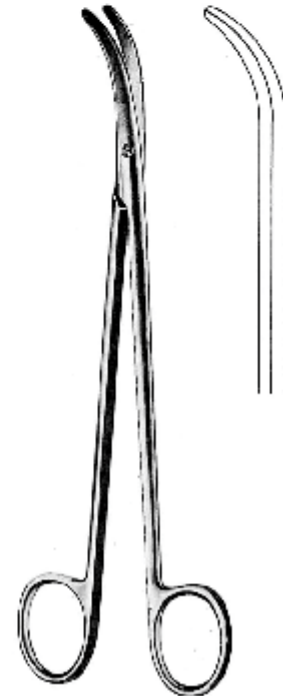

THOREK
 10.0326.19 19.0cm

SCISSORS



METZENBAUM-BABY
10.0330.11 11.5cm 10.0331.11

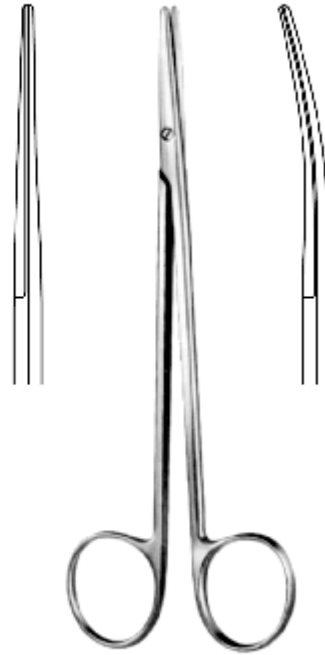

METZENBAUM
10.0336.15 15.0cm 10.0337.15

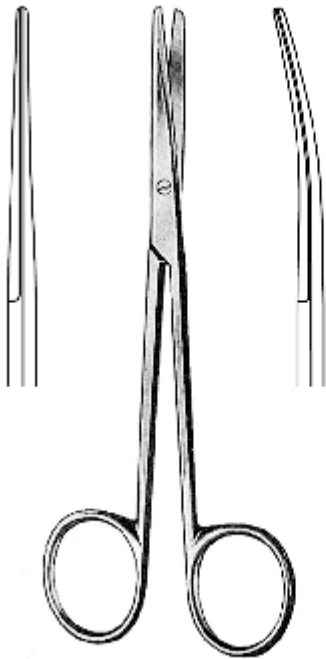

METZENBAUM
10.0340.14 14.5cm 10.0341.14

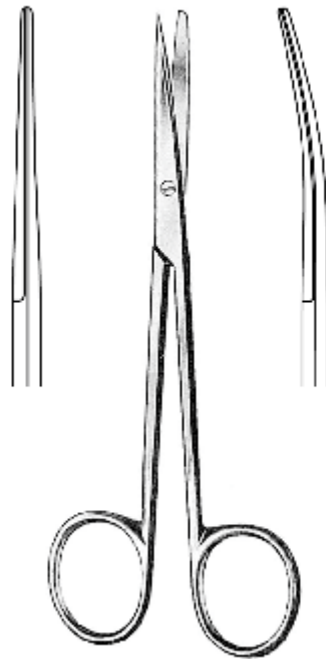

METZENBAUM
10.0342.14 14.5cm 10.0343.14

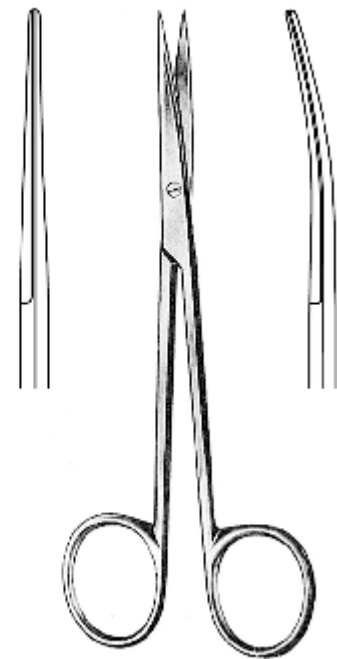

METZENBAUM
10.0344.14 14.5cm 10.0345.14

Dissecting Scissors
 Präparierscheren
 Tijeras para Preparaciones
 Ножницы препаровальные
 解剖剪

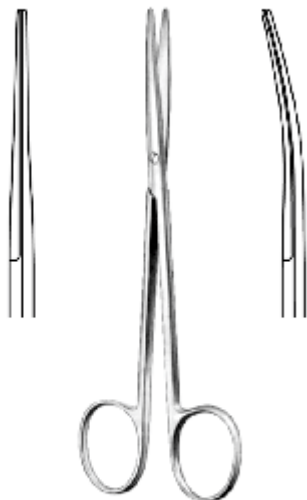

METZENBAUM-FINO
 10.0350.14 14.5cm 10.0351.14

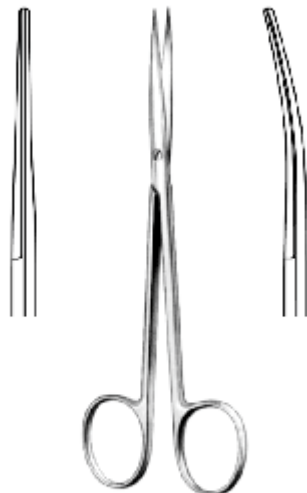

METZENBAUM-FINO
 10.0352.14 14.5cm 10.0353.14

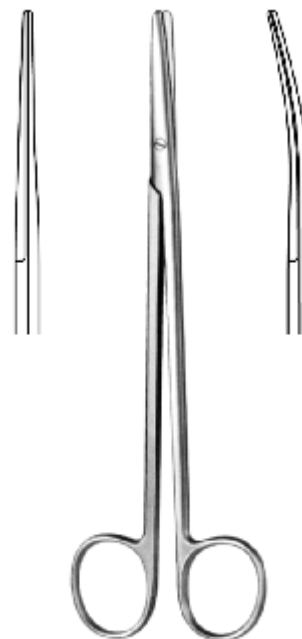

METZENBAUM-FINO
 10.0360.18 18.0cm 10.0361.18
 10.0360.20 20.0cm 10.0361.20
 10.0360.23 23.0cm 10.0361.23

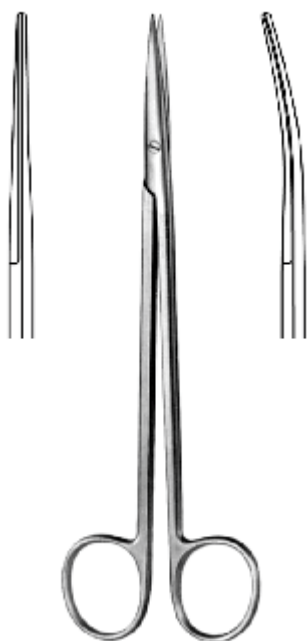

METZENBAUM-FINO
 10.0362.18 18.0cm 10.0363.18
 10.0362.20 20.0cm 10.0363.20
 10.0362.23 23.0cm 10.0363.23



METZENBAUM-FINO
 10.0370.18 18.0cm
 10.0370.20 20.0cm
 10.0370.23 23.0cm



METZENBAUM-FINO
 10.0374.18 18.0cm
 10.0374.20 20.0cm
 10.0374.23 23.0cm

SCISSORS

SCISSORS

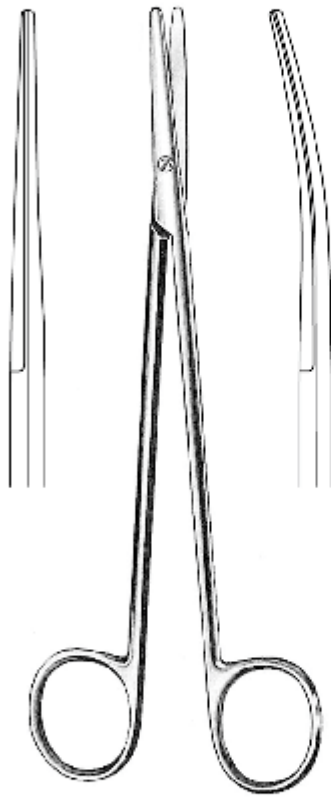

METZENBAUM - NELSON
10.0380.18 18.0cm 10.0381.18
10.0380.20 20.0cm 10.0381.20
10.0380.23 23.0cm 10.0381.23
10.0380.25 25.0cm 10.0381.25
10.0380.28 28.0cm 10.0381.28
10.0380.30 30.0cm 10.0381.30

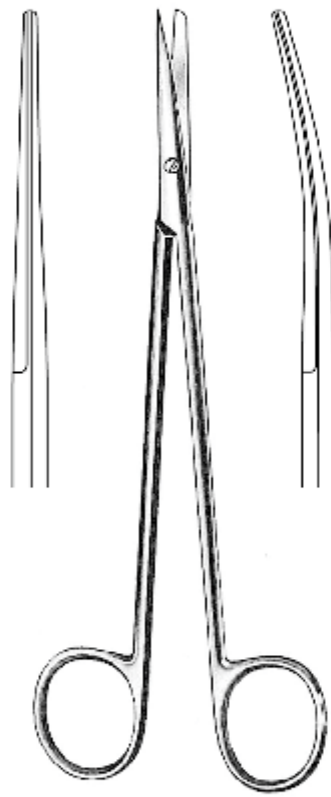

METZENBAUM - NELSON
10.0382.18 18.0cm 10.0383.18
10.0382.20 20.0cm 10.0383.20
10.0382.23 23.0cm 10.0383.23
10.0382.25 25.0cm 10.0383.25
10.0382.28 28.0cm 10.0383.28
10.0382.30 30.0cm 10.0383.30

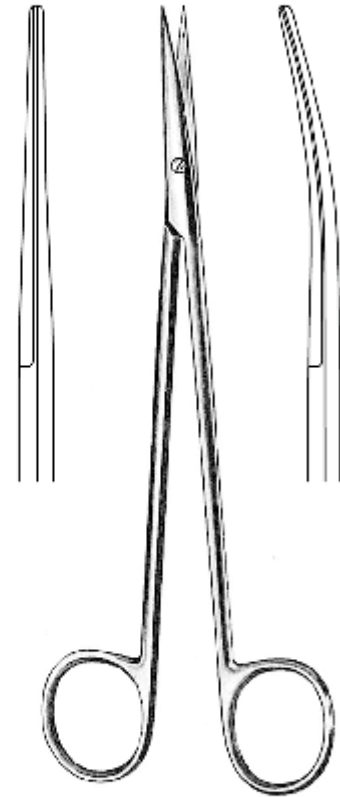

METZENBAUM - NELSON
10.0384.18 18.0cm 10.0385.18
10.0384.20 20.0cm 10.0385.20
10.0384.23 23.0cm 10.0385.23
10.0384.25 25.0cm 10.0385.25
10.0384.28 28.0cm 10.0385.28
10.0384.30 30.0cm 10.0385.30

Tonsil and Nasal Scissors
 Tonsillen-und-Nasenscheren
 Tijeras nasales y para Amigdalas
 Ножницы для миндалин, Ножницы носовые
 扁桃体和鼻剪刀

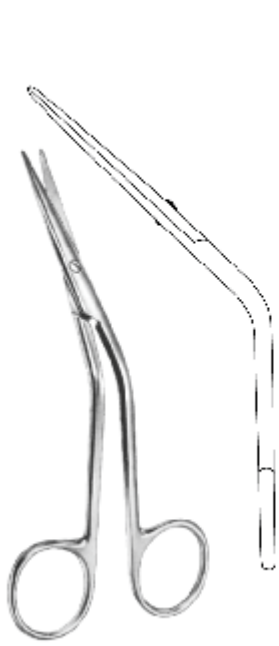

FOMON
 10.0400.15 15.0cm



COTTLE
 10.0406.16 16.0cm

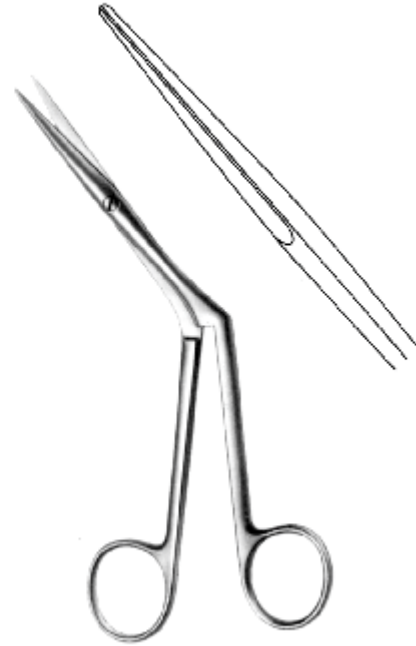

HEYMANN
 10.0410.18 18.0cm

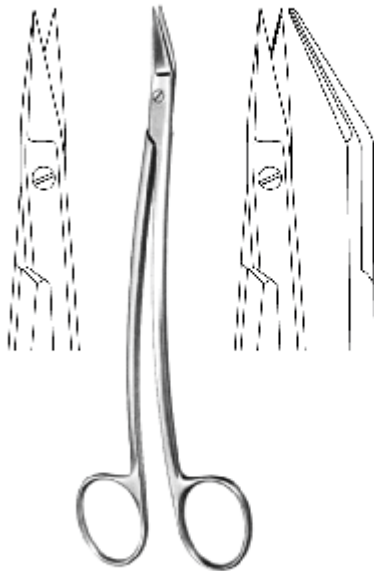

DEAN
 10.0414.17 17.0cm 10.0416.17

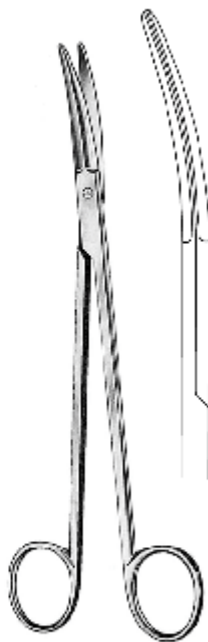

BOETTCHER
 10.0420.18 18.0cm



PRINCE
 10.0424.17 17.0cm

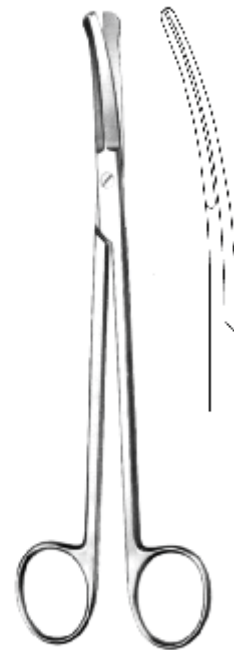

GOOD
 10.0428.19 19.0cm

SCISSORS

SCISSORS

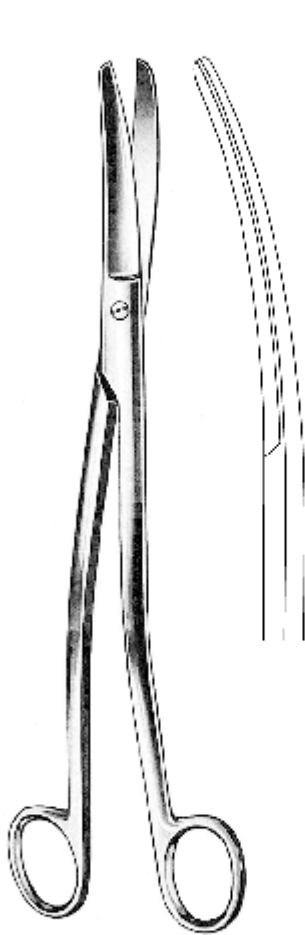

KLINKENBERGH-LOTH
10.0500.23 23.0cm

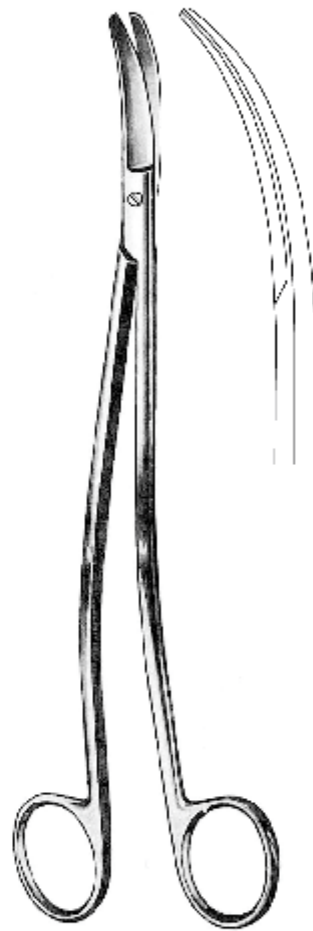

SATINSKY
10.0504.24 24.5cm



CRAFOORD
10.0510.30 30.0cm

Thorax and Vascular Scissors
 Thoraxcheren, Gefabscheren
 Tijeras Tracicas y Vasculares
 Ножницы сосудистые, Ножницы для грудной хирургии
 胸腔组织剪

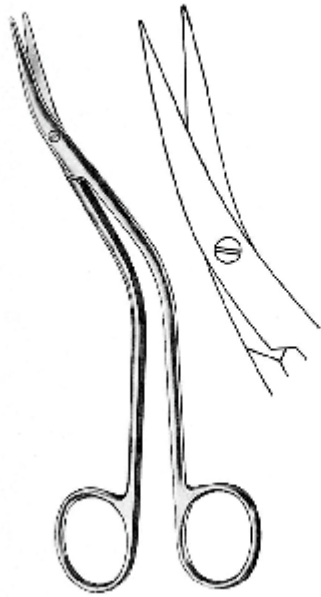

DE BAKEY
 10.0514.15 15.5cm

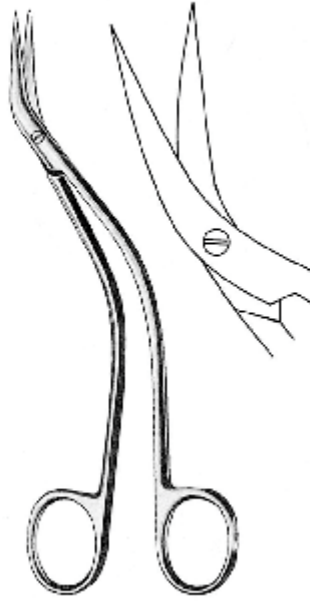

DE BAKEY
 10.0516.15 15.5cm

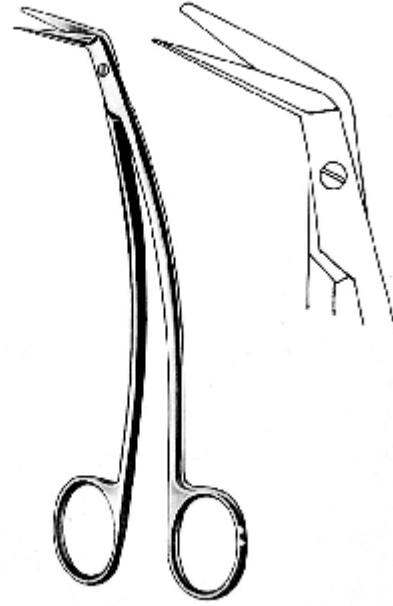

FAVALORO
 10.0518.15 15.0cm

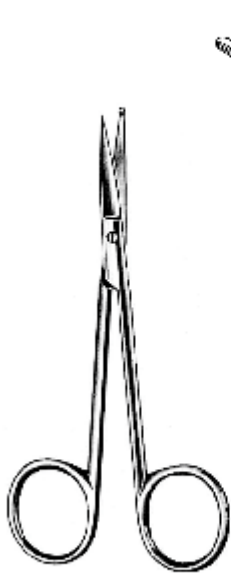

10.0520.11 11.5cm



PARAMETRIUM
 10.0522.22 22.5cm
 10.0522.23 23.0cm



MC INDOE
 10.0524.19 19.0cm

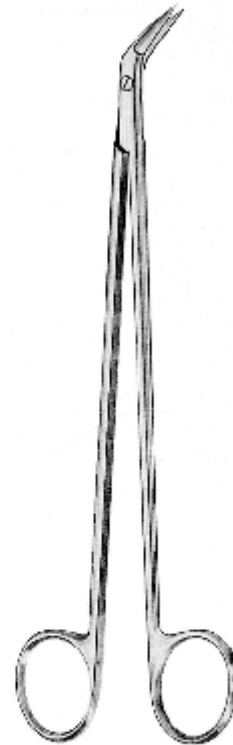

POTTS DE MARTEL
 10.0530.21 21.0cm
 10.0530.24 24.0cm

SCISSORS

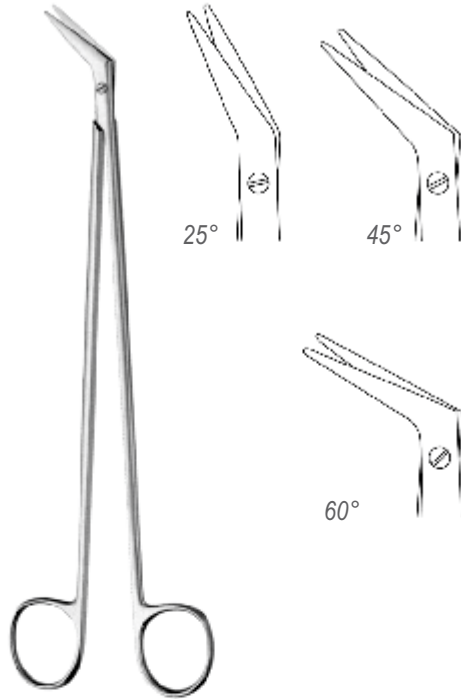

DE BAKEY

	25°	45°	60°
16.0cm	10.0534.16	10.0536.16	10.0538.16
23.0cm	10.0534.23	10.0536.23	10.0538.23
28.0cm	10.0534.28	10.0536.28	10.0538.28

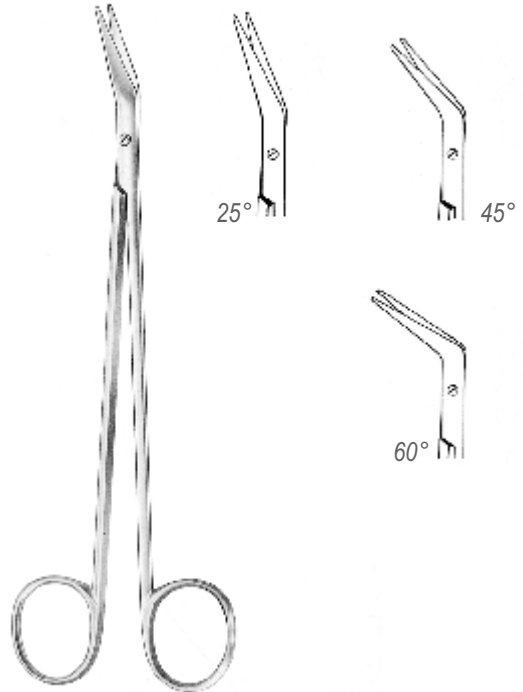

POTTS - SMITH

19.0cm	25°	45°	60°
10.0540.25			
10.0540.45			
10.0540.60			

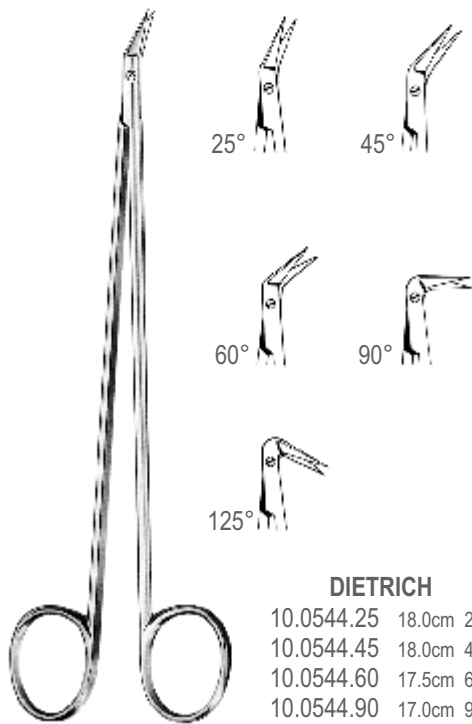

DIETRICH

	18.0cm	25°
10.0544.25		
10.0544.45		
10.0544.60	17.5cm	60°
10.0544.90	17.0cm	90°
10.0544.00	17.0cm	125°

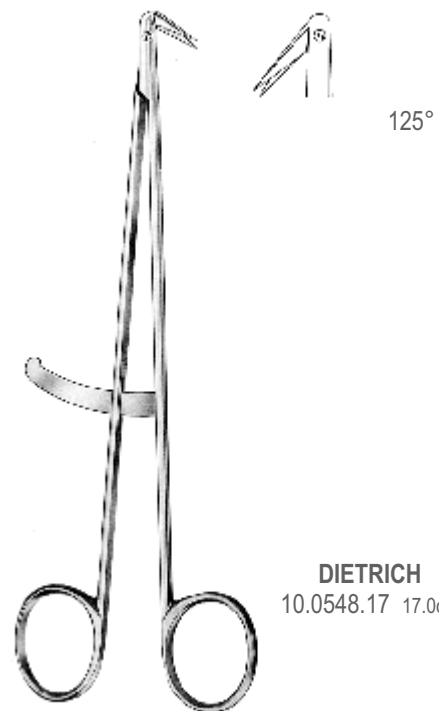

DIETRICH

10.0548.17	17.0cm
------------	--------



TOENNIS
 10.0600.18 18.0cm 10.0601.18



TOENNIS-ADSON
 10.0606.17 17.5cm



DANDY
 10.0610.17 17.0cm

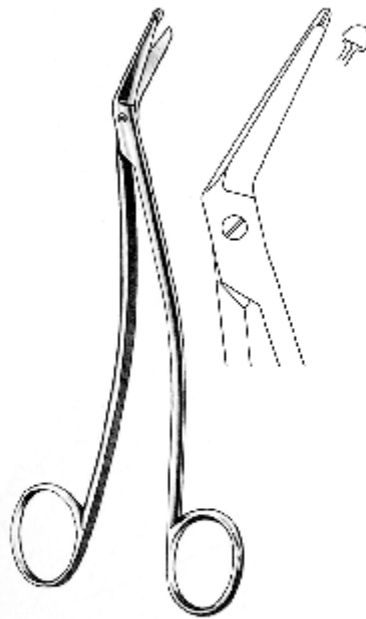

SCHMIEDEN-TAYLOR
 10.0614.17 17.0cm

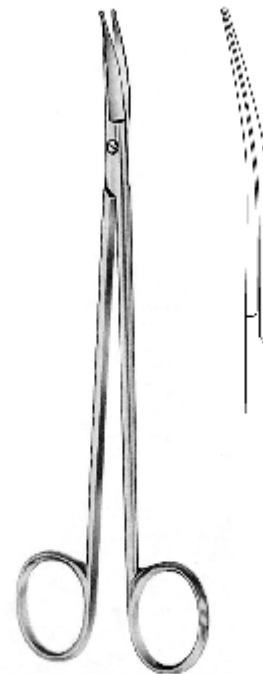

STRULLY
 10.0618.22 22.0cm

SCISSORS

Abdominal, Cephalotomy and Fistula Scissors
 Bauchdeckdecken-Kephalotom und Fistel-Scheren
 Tijeras abdominales, para decapeccion y para fistulas
 Ножницы абдоминальные, Ножницы для свищей
 (腹部, 头颅切开术瘻剪刀)



KELLY



1

10.0630.16 16.0cm



2

10.0630.18 18.0cm



3

10.0631.16 16.0cm



4

10.0631.18 18.0cm

SCISSORS



DUBOIS

10.0636.27 27.0cm 10.0637.27

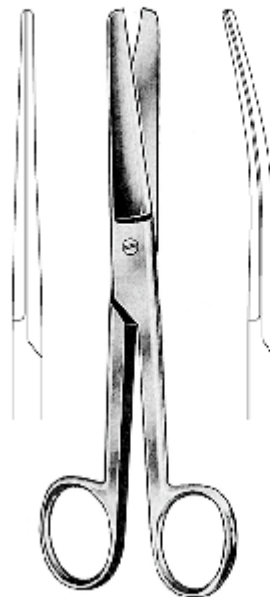

DOYEN

10.0640.17 17.0cm 10.0641.17

Gynecological & Rectal Scissors
 Gynakologische und mastdarm Scheren
 Tijeras para ginecologia rectales
 Ножницы гинекологические, Ножницы ректальные
 妇科直肠剪刀

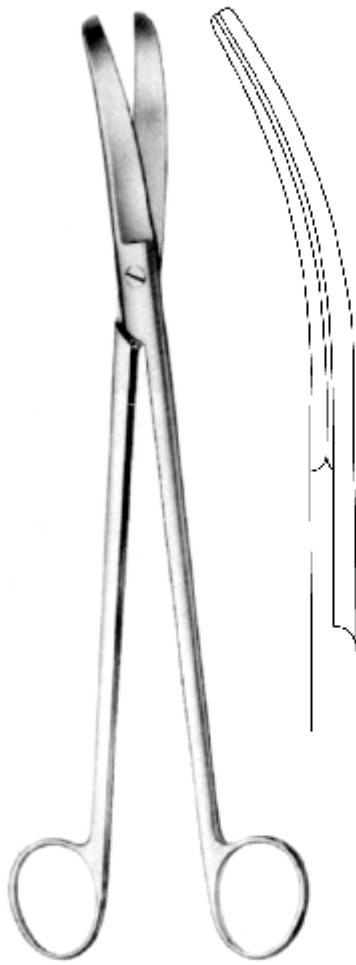

LLOYD-DAVIES (GOLIGHER'S)
 10.0646.27 27.0cm



SIEBOLD
 10.0650.24 24.0cm

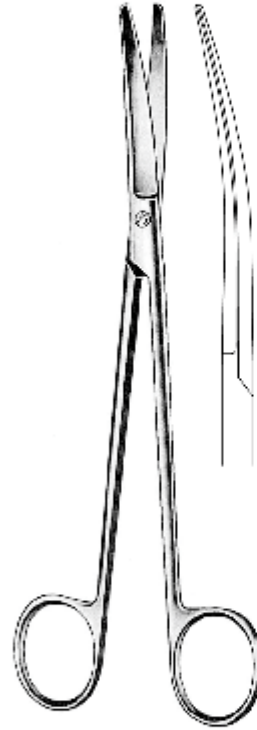

WERTHEIM
 10.0654.14 14.5cm
 10.0654.19 19.5cm
 10.0654.22 22.5cm

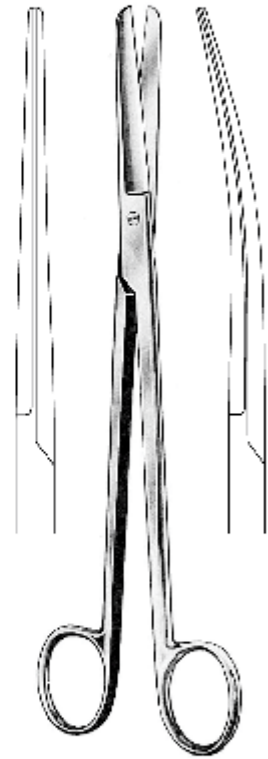

SIMS
 10.0660.20 20.0cm 10.0661.20
 10.0660.23 23.0cm 10.0661.23

SCISSORS

Umbilical, Episiotomy And Enterotomy Scissors
 Nabelschnur- Episiotomie-und Darmscheren
 Tijeras umbilicales, p/episiotmia y p/enterotomes
 Ножницы для пуповины, Ножницы для эпизиотомии и Ножницы для энтеротомии
 脐，会阴切开术和肠切开剪刀

SCISSORS



BUSCH
10.0670.16 16.0cm



BUSCH
10.0672.16 16.0cm

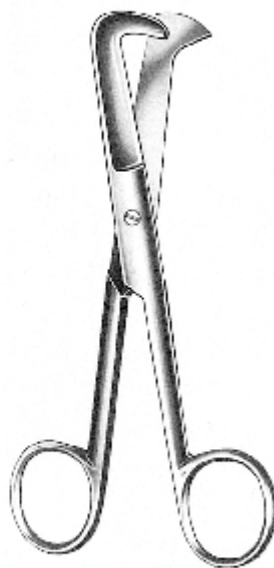

SCHUHMACHER
10.0674.16 15.5cm

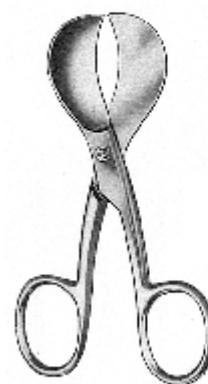

MOD.USA
10.0680.10 10.5cm
10.0680.12 12.5cm



LAWSON TAIT
10.0684.12 12.5cm



BRAUN-STADLER
10.0690.14 14.5cm
10.0690.22 22.0cm



WALDMANN
10.0694.18 18.0cm
10.0694.20 20.0cm
10.0694.24 24.0cm



10.0700.21 21.0cm



10.0702.21 21.0cm



10.0704.21 21.0cm

Ligature Scissors
 Ligaturscheren
 Tijeras para ligaduras
 Ножницы лигатурные
 钢丝剪、金冠剪

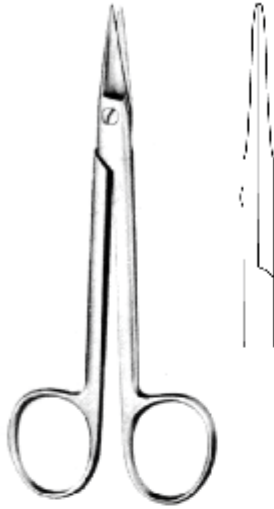

SYSTRUNK
 10.0800.13 13.0cm

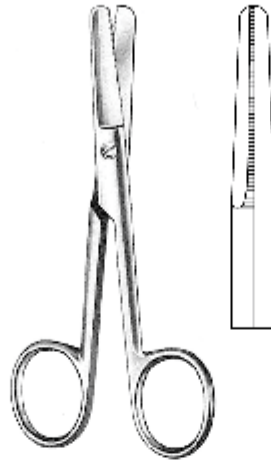

HARVEY
 10.0804.12 12.5cm

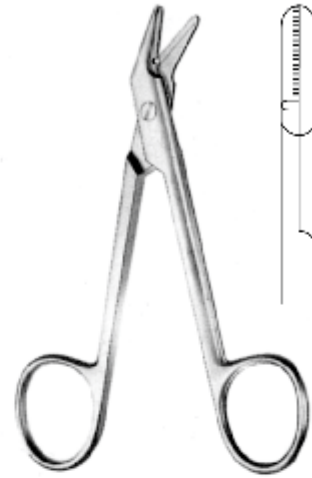

UNIVERSAL
 10.0808.12 12.0cm

SCISSORS



BEEBEE

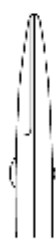

10.0810.10



(sharp)
 10.0cm



10.0811.10



10.0812.10



(blunt)
 10.0cm



10.0813.10



10.0814.12



(saw edge)
 12.0cm



10.0815.12



SPENCER
10.0820.09 9.0cm

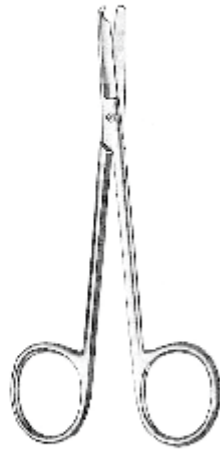

SPENCER
10.0820.13 13.0cm



LITTAUER
10.0822.14 14.0cm

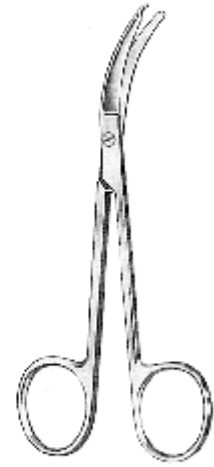

NORTHBENT
10.0824.13 13.0cm

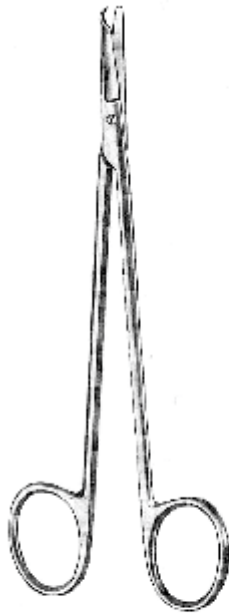

BUCK
10.0826.14 14.5cm
10.0826.18 18.0cm

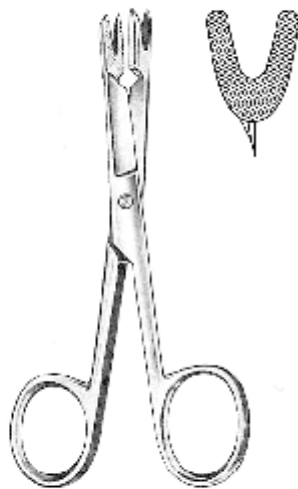

SCHOEMAKER-LOTH
10.0830.13 13.0cm

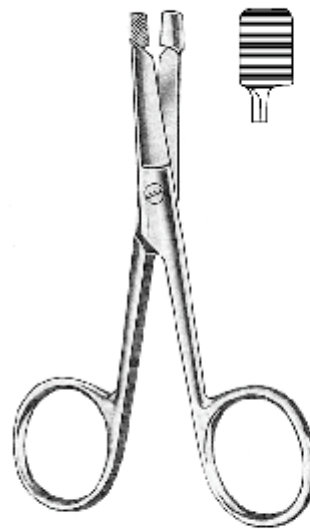

EISELSBERG
10.0834.12 12.0cm

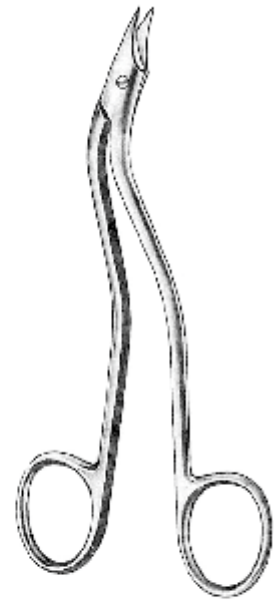

HEATH
10.0838.15 15.0cm

Micro Scissors
 Mikro-Scheren
 Micro tijeras
 Микро-ножницы
 显微剪



10.0900.09



10.0900.09 9.0cm



10.0901.09 9.0cm



10.0906.09 9.0cm
 10.0906.12 12.0cm



10.0910.09 9.0cm



10.0914.11 11.0cm

SCISSORS



10.0920.14 14.0cm
 10.0920.18 18.5cm



10.0921.15 15.5cm
 10.0921.18 18.5cm



10.0923.15 15.5cm
 (1 saw edge)



10.0925.18 18.5cm

SCISSORS



18.0cm



10.0930.18
straight



10.0931.18
curved

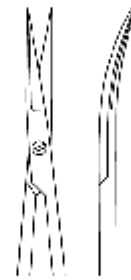

10.0933.18
curved down



10.0934.18
angled



JACOBSON
10.0940.15 15.5cm
10.0940.22 22.5cm



POTTS
10.0941.15 15.5cm
10.0941.22 22.5cm



10.0946.15 15.5cm
10.0946.18 18.5cm
10.0946.22 22.5cm



10.0947.15 15.5cm
10.0947.18 18.5cm
10.0947.22 22.5cm

Micro Scissors
 Mikro-Scheren
 Micro tijeras
 Микро-ножницы
 显微剪



GOMEL

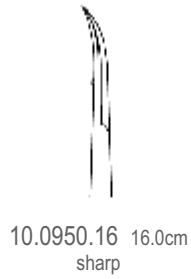

HEPP/SCHIEDEL

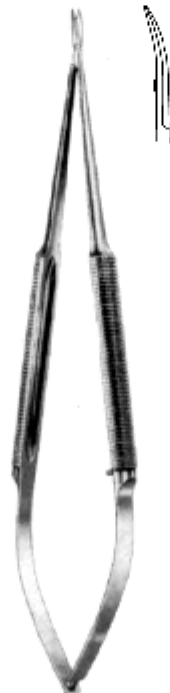
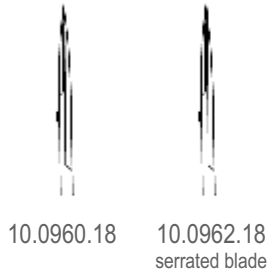

10.0970.18 18.0cm



HEPP / SCHEIDEL
 10.0974.18 18.0cm



HEPP / SCHEIDEL
 10.0976.18 18.0cm

SCISSORS



Micro Scissors
Mikro-Scheren
Micro tijeras
Микро-ножницы
显微剪

SCISSORS



18.0cm



25°

10.0980.25



45°

10.0980.45



60°

10.0980.60

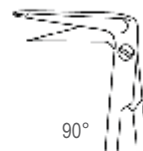

90°

10.0980.90



125°

10.0980.00



18.0cm



25°

10.0984.25



45°

10.0984.45



60°

10.0984.60

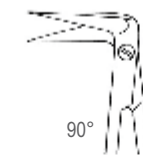

90°

10.0984.90



125°

10.0984.00

10
10-024



SURGICAL
INSTRUMENTS



THE ULTIMATE CHOICE

Hilton
PREMIUM STAINLESS STEEL

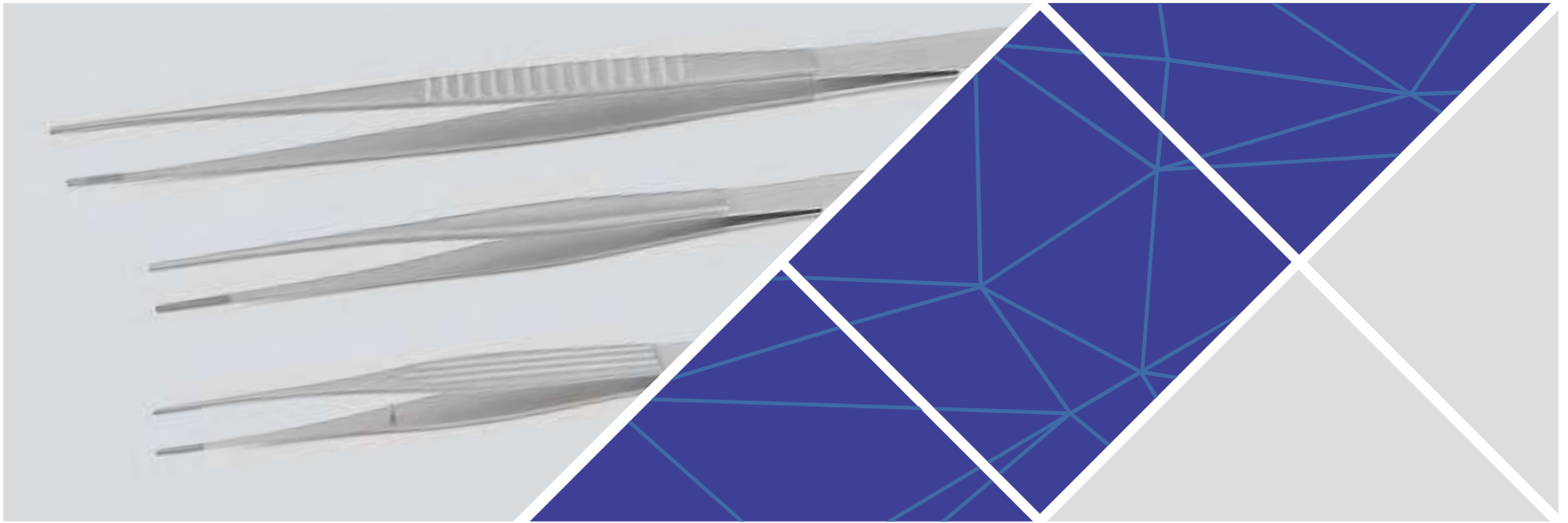

THE ULTIMATE CHOICE

DRESSING & TISSUE FORCEPS

Dressing and Tissue Forceps
Anatomische und Chirurgische Pinzetten
Pinzas de diseccion con dientes
ПИНЦЕТЫ
修整和组织钳

12

001 - 016



STANDARD

STANDARD

12.0010.10	10.5cm
12.0010.11	11.5cm
12.0010.13	13.0cm
12.0010.14	14.5cm
12.0010.16	16.0cm
12.0010.18	18.0cm
12.0010.20	20.0cm
12.0010.23	23.0cm
12.0010.25	25.0cm
12.0010.30	30.0cm

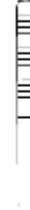

NARROW

12.0012.10	10.5cm
12.0012.11	11.5cm
12.0012.13	13.0cm
12.0012.14	14.5cm
12.0012.16	16.0cm
12.0012.18	18.0cm
12.0012.20	20.0cm
12.0012.23	23.0cm
12.0012.25	25.0cm
12.0012.30	30.0cm



USA MODEL



12.0016.12	12.0cm
12.0016.13	13.0cm
12.0016.14	14.5cm
12.0016.15	15.0cm
12.0016.18	18.0cm
12.0016.21	21.0cm
12.0016.25	25.0cm
12.0016.31	31.0cm



12.0018.12	12.0cm
12.0018.13	13.0cm
12.0018.14	14.5cm
12.0018.15	15.0cm
12.0018.18	18.0cm
12.0018.21	21.0cm
12.0018.25	25.0cm



STILLE
12.0022.15
15.0cm



OCHSNER
12.0028.14
14.0cm

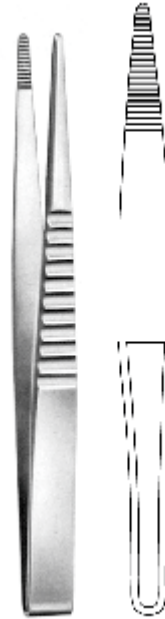

12.0032.12 12.0cm
12.0032.15 15.0cm
12.0032.18 18.0cm
12.0032.20 20.0cm
12.0032.25 25.0cm

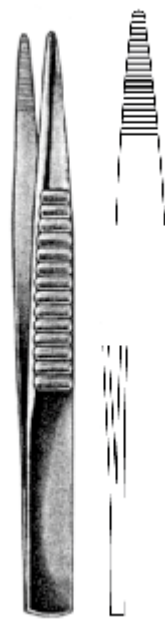

12.0038.12 12.0cm
12.0038.15 15.0cm
12.0038.18 18.0cm
12.0038.20 20.0cm
12.0038.25 25.0cm



BONNEY
12.0046.17
17.5cm



RAMSEY
12.0050.18
18.0cm



DUEHRSSSEN
12.0054.20
20.0cm



WANGENSTEEN
12.0058.23
23.0cm

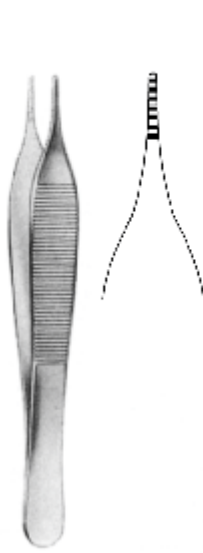

ADSON
 12.0066.12 12.0cm
 12.0066.15 15.0cm
 12.0066.19 19.0cm



McINDOE
 12.0070.15 15.0cm



SEMKEN
 12.0076.12 12.0cm 12.0077.12
 12.0076.15 15.0cm 12.0077.15



CUSHING
 12.0080.17 17.0cm 12.0081.17



POTTS.SMITH
 12.0084.18 18.0cm
 12.0084.21 21.0cm
 12.0084.25 25.0cm
 12.0084.30 30.0cm



WAUGH
 12.0088.15 15.0cm
 12.0088.18 18.0cm
 12.0088.20 20.0cm

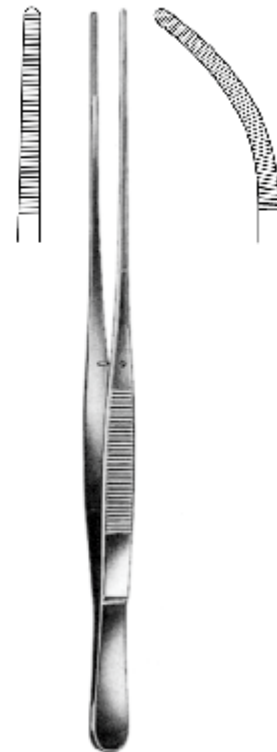

BROPHY
 12.0092.20 20.0cm 12.0093.20

DRESSING & TISSUE FORCEPS



GERALD
12.0094.18 18.0cm

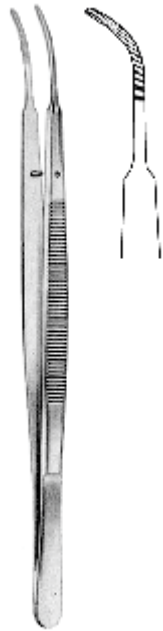

GERALD
12.0095.18 18.0cm



GERALD
12.0098.18 18.0cm



TAYLOR
12.0100.17 17.5cm
12.0101.17 17.5cm



TAYLOR
12.0102.17 18.5cm



TAYLOR
12.0104.17 17.5cm

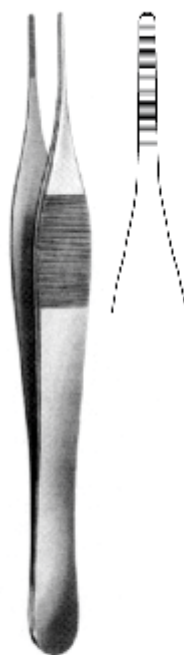

JEFFERSON
12.0106.18 18.0cm, 180mm

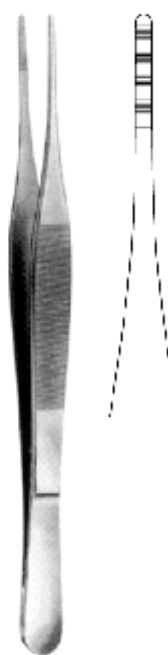

ADSON
12.0108.18 18.0cm, 180mm

Tissue Forceps
 Chirurgische Pinzetten
 Pinzas de diseccion con dientes
 Пинцеты хирургические
 组织镊



DRESSING & TISSUE FORCEPS



STANDARD

	SLENDER 1:2	DELICATE 1:2	REGULAR 1:2	2:3	3:4	4:5
10.0cm			12.0114.10	12.0116.10	12.0118.10	12.0120.10
11.0cm	12.0110.11		12.0114.11	12.0116.11	12.0118.11	12.0120.11
13.0cm	12.0110.13	12.0112.13	12.0114.13	12.0116.13	12.0118.13	12.0120.13
14.0cm	12.0110.14	12.0112.14	12.0114.14	12.0116.14	12.0118.14	12.0120.14
16.0cm	12.0110.16	12.0112.16	12.0114.16	12.0116.16	12.0118.16	12.0120.16
18.0cm	12.0110.18	12.0112.18	12.0114.18	12.0116.18	12.0118.18	12.0120.18
20.0cm	12.0110.20	12.0112.20	12.0114.20	12.0116.20	12.0118.20	12.0120.20
23.0cm			12.0114.23			
25.0cm			12.0114.25	12.0116.25	12.0118.25	12.0120.25
30.0cm			12.0114.30	12.0116.30	12.0118.30	12.0120.30



USA MODEL

	1:2	2:3	3:4	4:5
12.0cm				
13.0cm	12.0124.12	12.0126.13	12.0128.13	12.0130.13
14.0cm	12.0124.13	12.0126.14	12.0128.14	12.0130.14
15.0cm	12.0124.14	12.0126.15	12.0128.15	12.0130.15
18.0cm	12.0124.15			
21.0cm	12.0124.18			
25.0cm	12.0124.21			
31.0cm	12.0124.25			
	12.0124.31			



STILLE
12.0134.15 15.0cm
12.0136.15 15.0cm



TREVES
12.0140.12 12.5cm
12.0140.15 15.0cm
12.0140.18 18.0cm
12.0140.20 20.0cm
12.0140.25 25.0cm



ADLERKREUTZ



12.0142.15 15.0cm



12.0142.20 20.0cm



12.0144.15 15.0cm



12.0144.20 20.0cm



12.0144.25 25.0cm



STILLE-BARRAYA



12.0148.18 18.0cm



12.0148.20 20.0cm



12.0148.25 25.0cm



BROPHY
12.0152.20 20.0cm 12.0153.20

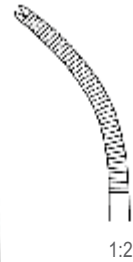

BONNEY
12.0156.18 18.0cm 12.0158.18



Tissue Forceps
 Chirurgische Pinzetten
 Pinzas de diseccion con dientes
 Пинцеты хирургические
 组织镊



DRESSING & TISSUE FORCEPS



ADSON
 12.0160.18 18.0cm

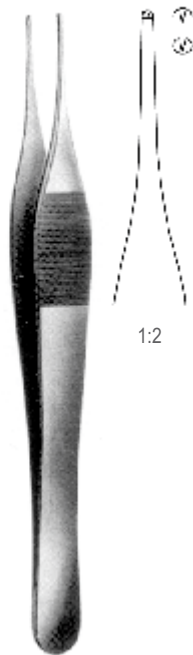

JEFFERSON
 12.0162.18 18.0cm

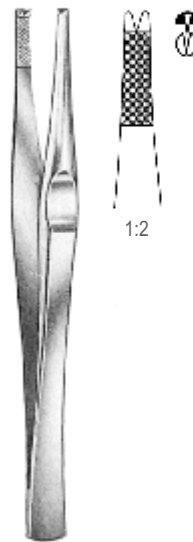

LANES
 12.0166.12 12.5cm
 12.0166.15 15.0cm
 12.0166.18 18.0cm
 12.0166.20 20.0cm

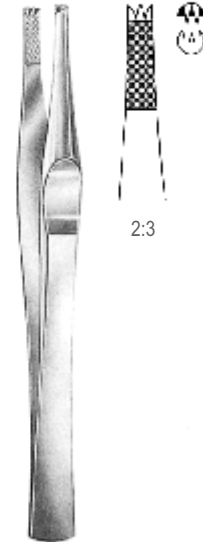

LANES
 12.0168.12 12.5cm
 12.0168.15 15.5cm
 12.0168.18 18.0cm
 12.0168.20 20.0cm

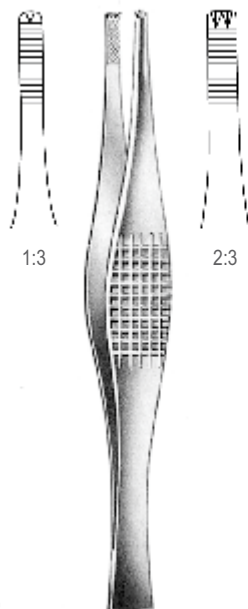

FERRIS-SMITH
 12.0172.18 18.0cm 12.0174.18



RAMSAY
 18.0cm

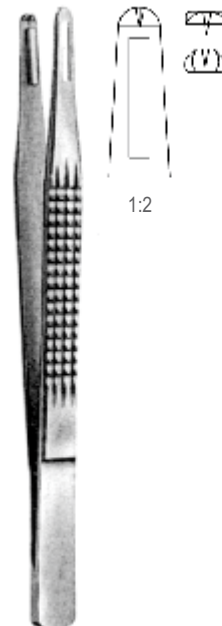

CHARNLEY
 12.0182.18 18.0cm



JEANS
 12.0188.14 14.5cm
 12.0188.17 17.5cm

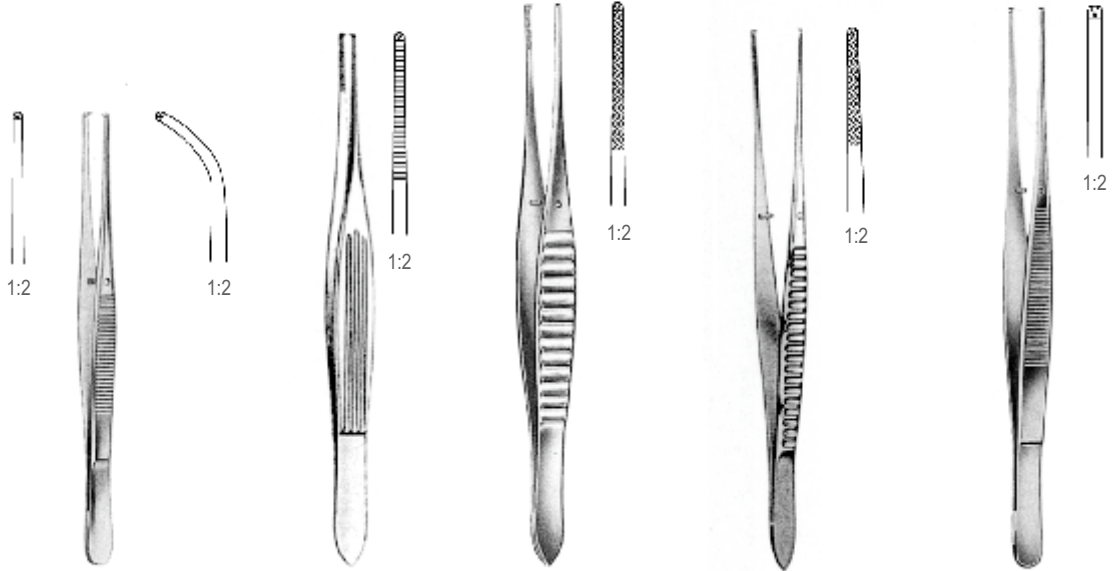

SEMKEN		McINDOE		GILLIES		WAUGH		POTTS.SMITH
12.0196.12 12.5cm	12.0197.12	12.0200.15 15.0cm	12.0204.15 15.0cm	12.0208.15 15.0cm	12.0208.18 18.0cm	12.0208.20 20.0cm	12.0212.18 18.0cm	12.0212.21 21.0cm
12.0196.15 15.0cm	12.0197.15						12.0212.25 25.0cm	12.0212.30 30.0cm

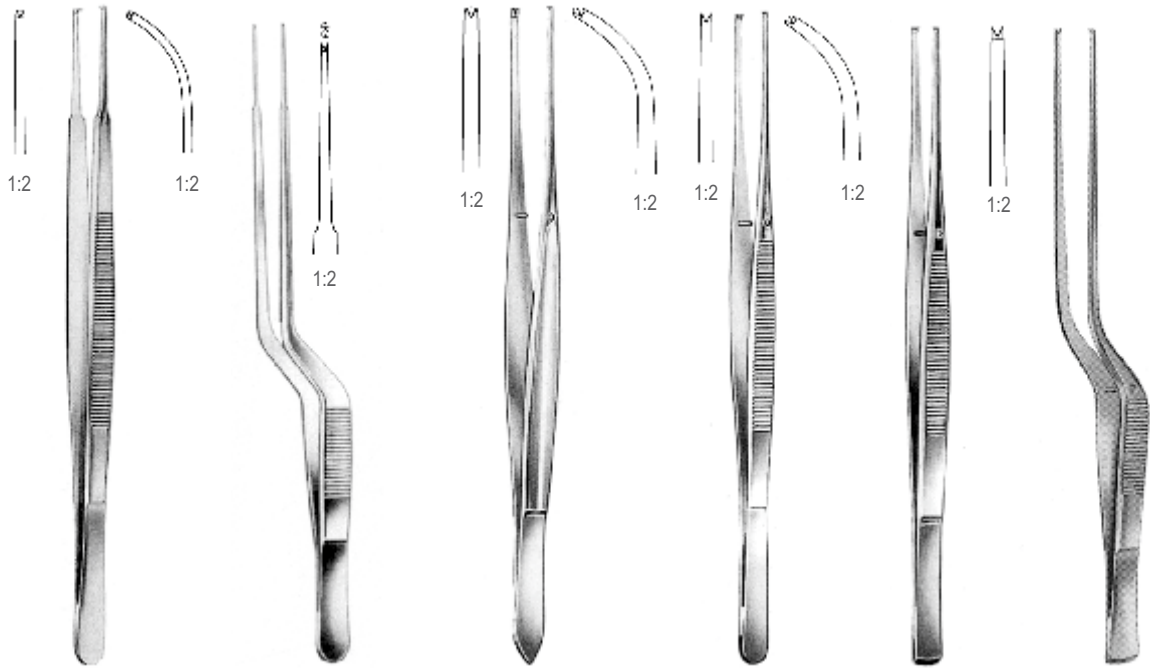

GERALD		GERALD		CUSHING		TAYLOR		TAYLOR		TAYLOR
12.0218.18 18.0cm	12.0219.18 18.0cm	12.0220.18 18.0cm	12.0222.17 17.5cm	12.0223.17 17.5cm	12.0228.17 17.5cm	12.0229.17 17.5cm	12.0232.17 17.5cm	12.0234.17 17.5cm		

Tissue Forceps
 Chirurgische Pinzetten
 Pinzas de diseccion con dientes
 Пинцеты хирургические, Пинцеты для тканей
 组织镊

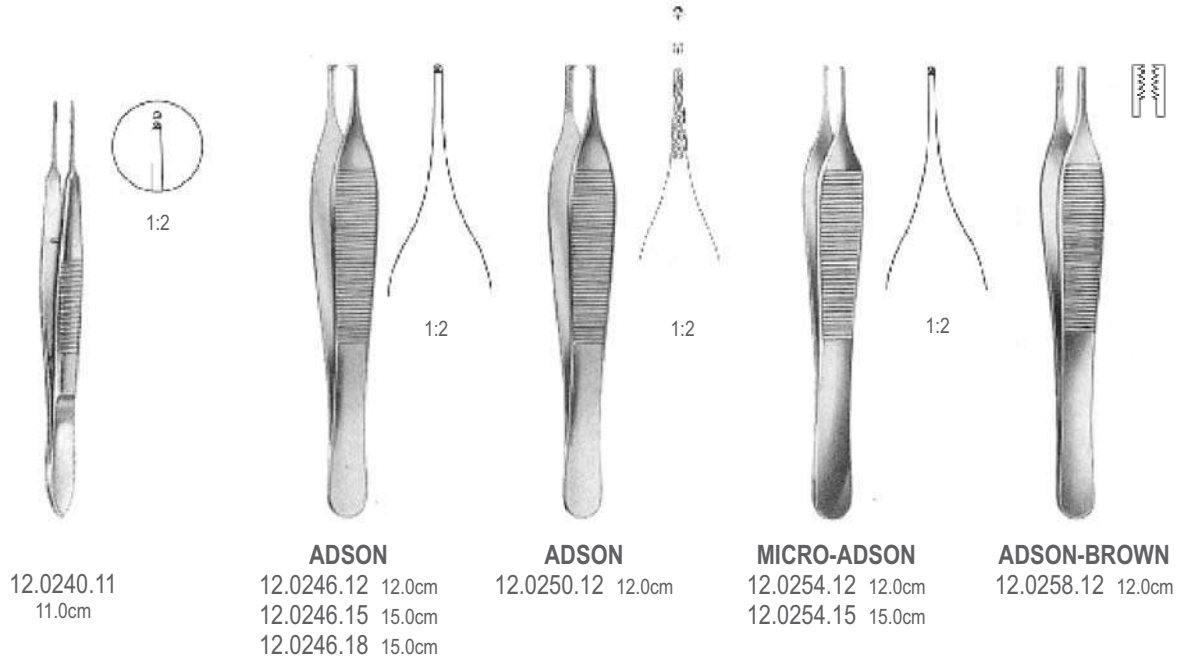

12.0240.11
11.0cm

ADSON
 12.0246.12 12.0cm
 12.0246.15 15.0cm
 12.0246.18 15.0cm

ADSON
 12.0250.12 12.0cm

MICRO-ADSON
 12.0254.12 12.0cm
 12.0254.15 15.0cm

ADSON-BROWN
 12.0258.12 12.0cm

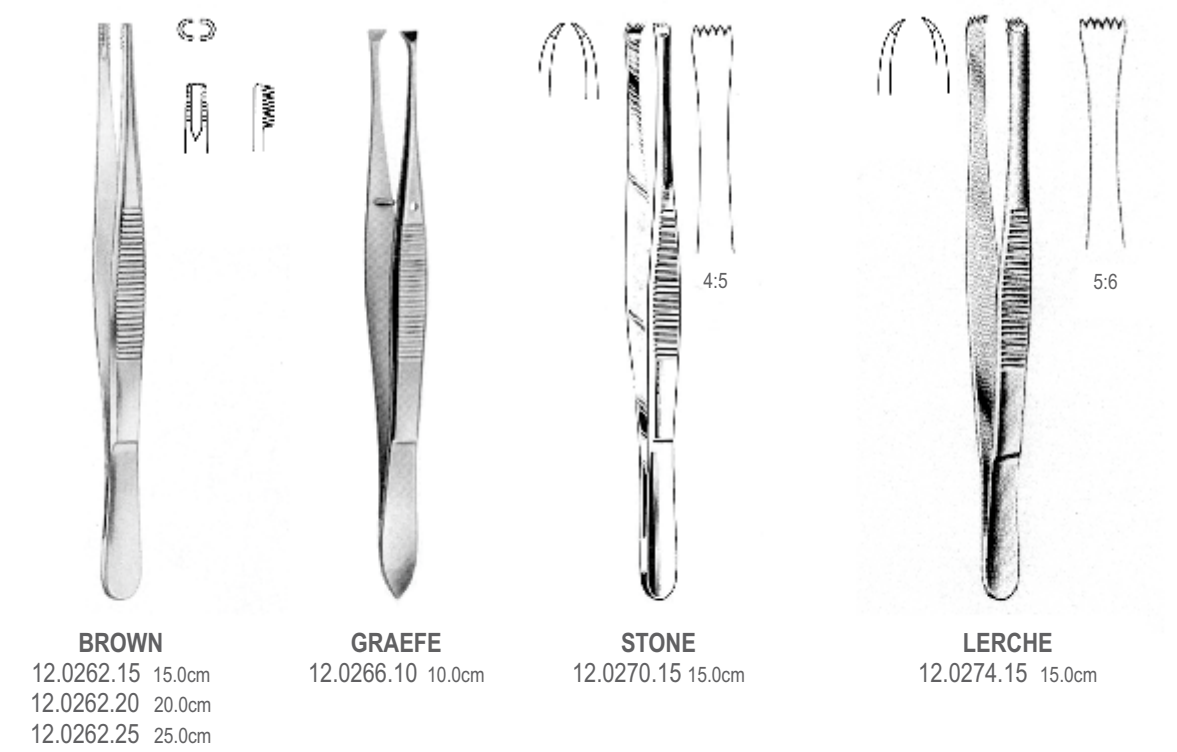

BROWN
 12.0262.15 15.0cm
 12.0262.20 20.0cm
 12.0262.25 25.0cm

GRAEFE
 12.0266.10 10.0cm

STONE
 12.0270.15 15.0cm

LERCHE
 12.0274.15 15.0cm

DRESSING & TISSUE FORCEPS

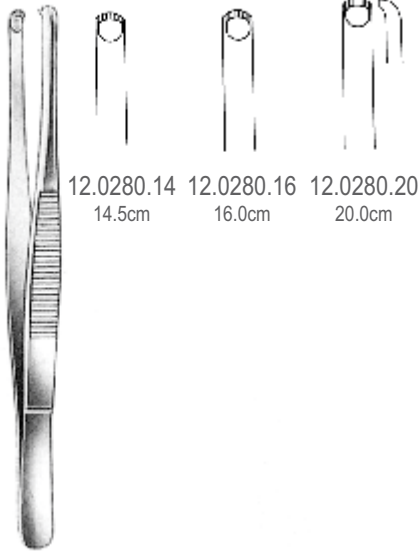

DURANTE

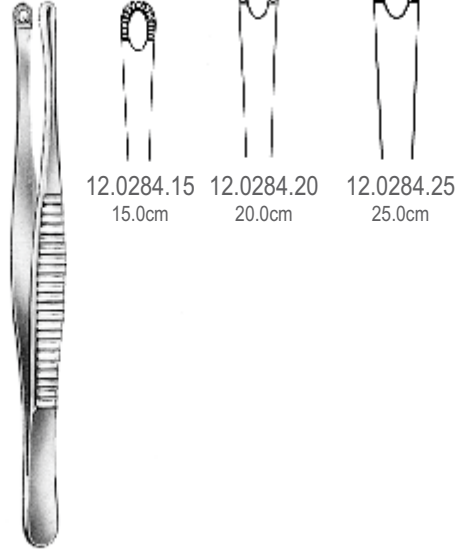

RUSS MODELL



MAYO RUSS
12.0288.23 23.0cm

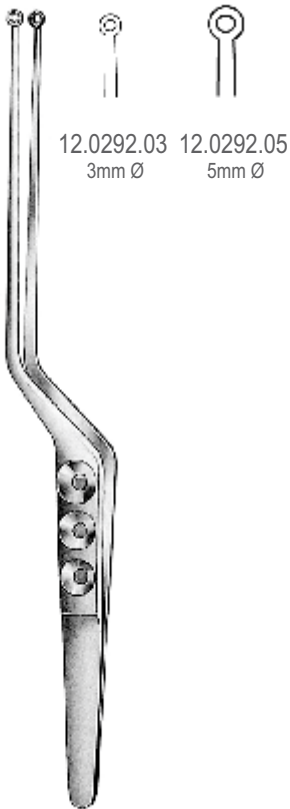

YASARGIL
22.0cm



YASARGIL
22.0cm

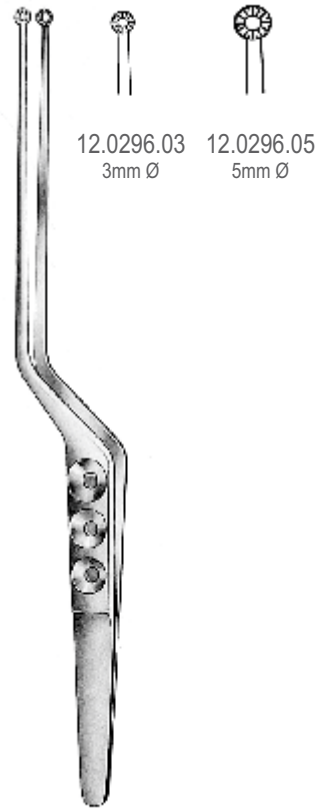

HEIFETZ
22.0cm

Tissue and Micro forceps, fine patterns
 Chirurgische und Mikro-Pinzetten, feine modelle
 De diseccion con dientes micro-pinzas, modelos finos
 Микропинцеты
 碎片镊、显微镊

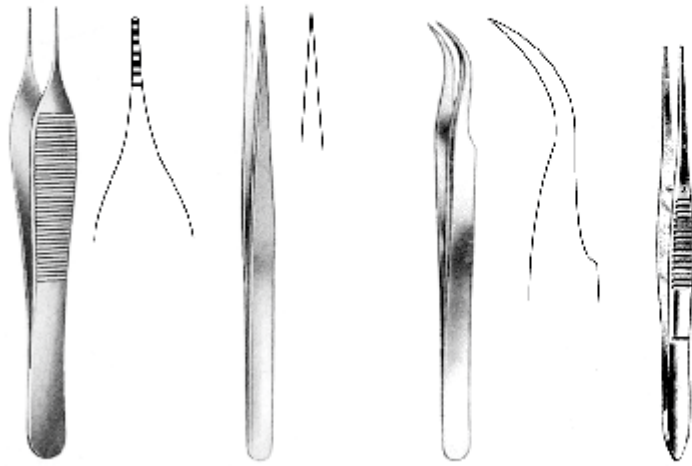

MICRO ADSON

12.0302.12 12.0cm 12.0306.12 12.0cm 12.0308.12 12.0cm
 12.0302.15 12.0cm 12.0306.16 16.0cm 12.0308.16 16.0cm

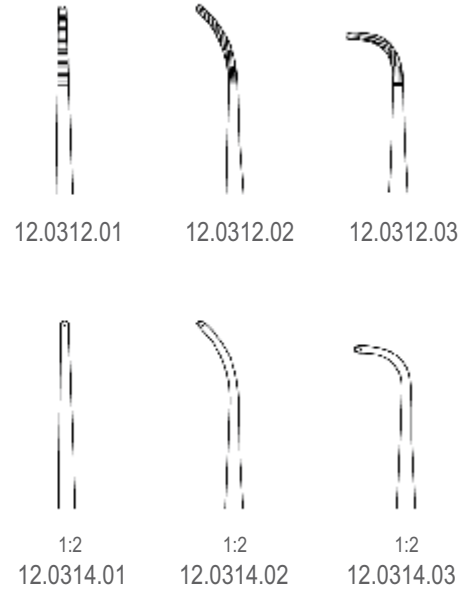

12.0312.01 12.0312.02 12.0312.03
 1:2 1:2 1:2
 12.0314.01 12.0314.02 12.0314.03

10.5cm

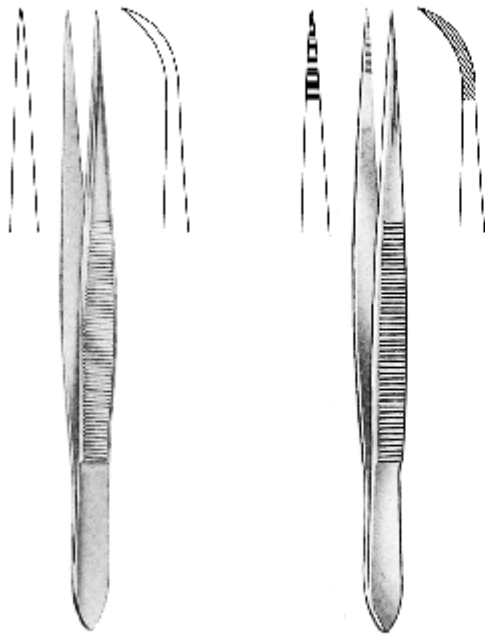

12.0318.09 09.0cm 12.0319.09 12.0320.09 09.0cm 12.0321.09
 12.0318.10 10.5cm 12.0319.10 12.0320.10 10.5cm 12.0321.10
 12.0318.11 11.5cm 12.0319.11 12.0320.11 11.5cm 12.0321.11
 12.0318.12 12.0cm 12.0319.12 12.0320.12 12.0cm 12.0321.12

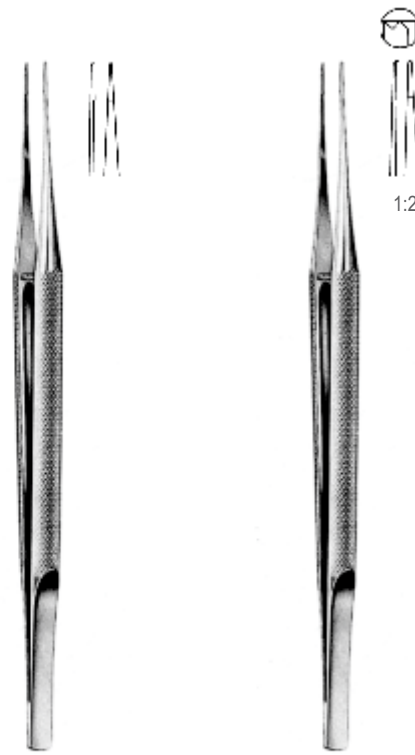

GOMEL

12.0326.18 18.0cm 12.0328.18

DRESSING & TISSUE FORCEPS



Micro Forceps
Mikro-Pinzetten
Micro-pinzas
Микропинцеты
微型镊子

DRESSING & TISSUE FORCEPS



12.0330.01

22.5cm



12.0330.02



18.5cm



12.0332.01



12.0332.02



12.0332.03

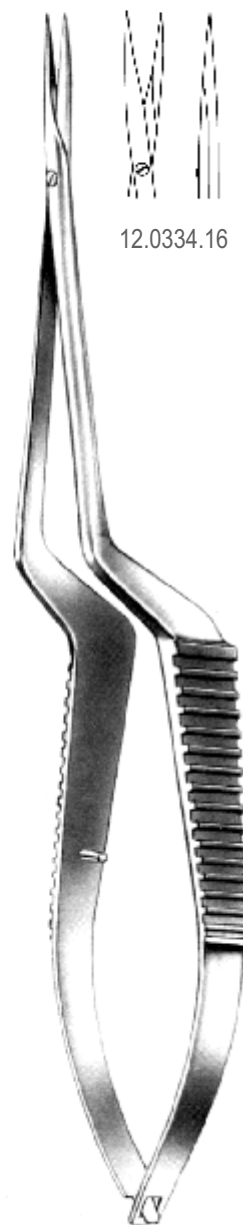

15.5cm



12.0334.16

Grasping Forceps
 Faßpinzetten
 Pinzas para coger
 Пинцеты захватывающие
 组织夹持镊

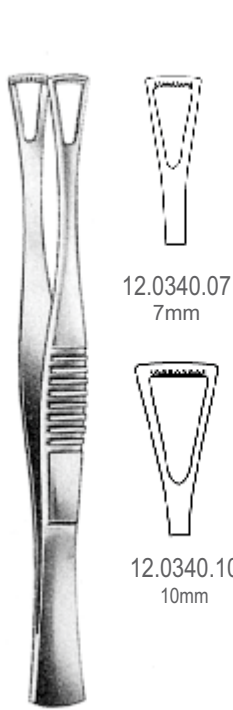

12.0340.07
7mm

12.0340.10
10mm

DUVAL
14.5cm

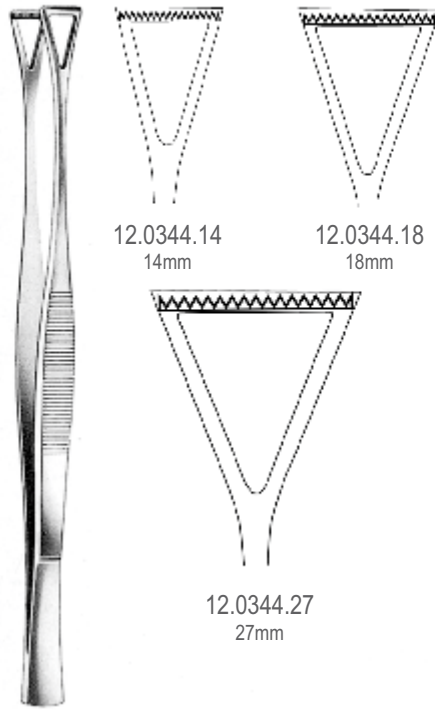

12.0344.14
14mm

12.0344.18
18mm

12.0344.27
27mm

COLLIN-DUVAL
20.0cm

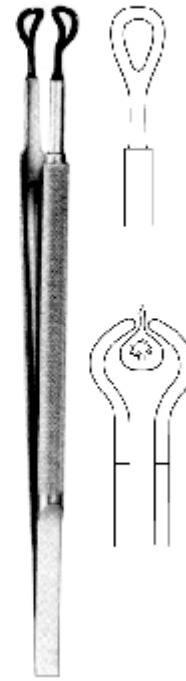

HEPP/SCHIEDL
12.0350.18 18.0cm



SINGLE-TUTTLE
12.0356.23 23.0cm



NELSON
12.0360.23 23.0cm



12.0364.21
21.0cm

DRESSING & TISSUE FORCEPS

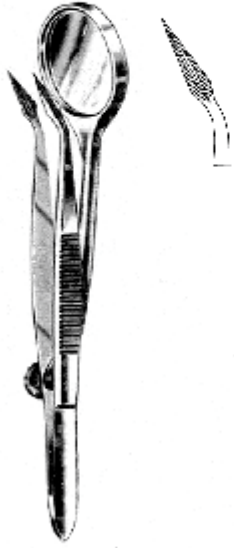

12.0370.12
12.0cm



FEILCHENFELD



12.0376.07
7.5cm



12.0376.09
9.0cm



12.0376.11
11.5cm



12.0380.12
12.5cm



12.0384.10



HUNTER
10.5cm



12.0385.10



12.0390.10



WALTER-CARMALT
10.5cm



12.0391.10

Splinter Forceps
Spitter-Pinzetten
Pinzas para espinas
Щипцы для извлечения заноз
分裂镊子



PEET
12.0396.11 11.5cm

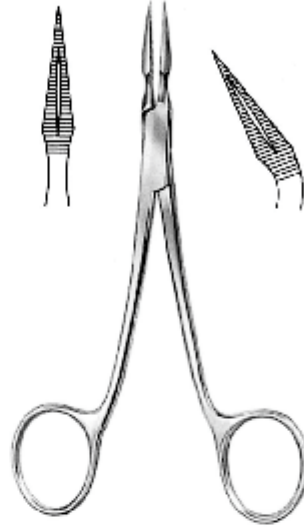

ARTHER
12.0400.14 14.0cm 12.0401.14

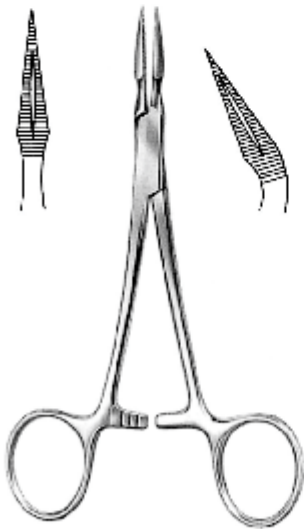

STIEGLITZ
12.0406.13 13.5cm 12.0407.13

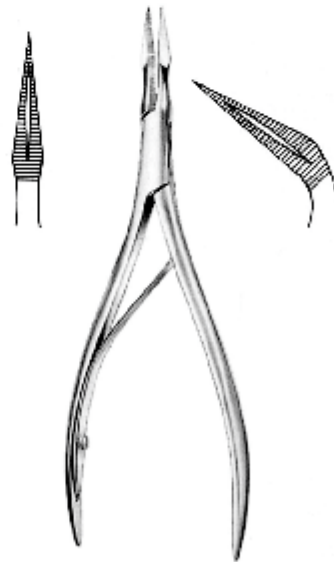

RALK
12.0412.15 15.0cm 12.0413.15

DRESSING & TISSUE FORCEPS



BEER
12.0430.09 9.0cm



LITTAUER
12.0434.08 8.5cm



12.0438.09 9.0cm



DOUGLAS
12.0442.09 9.0cm



DOUGLAS
12.0448.09 9.0cm



BARRAQUER
12.0454.10 10.5cm



GRADLE
12.0460.09 9.5cm



HENRY
12.0466.12 12.0cm



SURGICAL
INSTRUMENTS



THE ULTIMATE CHOICE

Hilton
PREMIUM STAINLESS STEEL



THE ULTIMATE CHOICE

ARTERY FORCEPS

Artery Forceps
Arterienklemmen
Pinzas hemostáticas
ЗАЖИМЫ АРТЕРИАЛЬНЫЕ
动脉钳

Bulldog Clamps, Setting Forceps
 Bulldogklemmen, Alegepinzetten
 Clamps bulldog, pinzas para poner
 Зажимы типа бульдог, Зажимы специальные для установки клипс
 斗牛犬夹, 设置镊

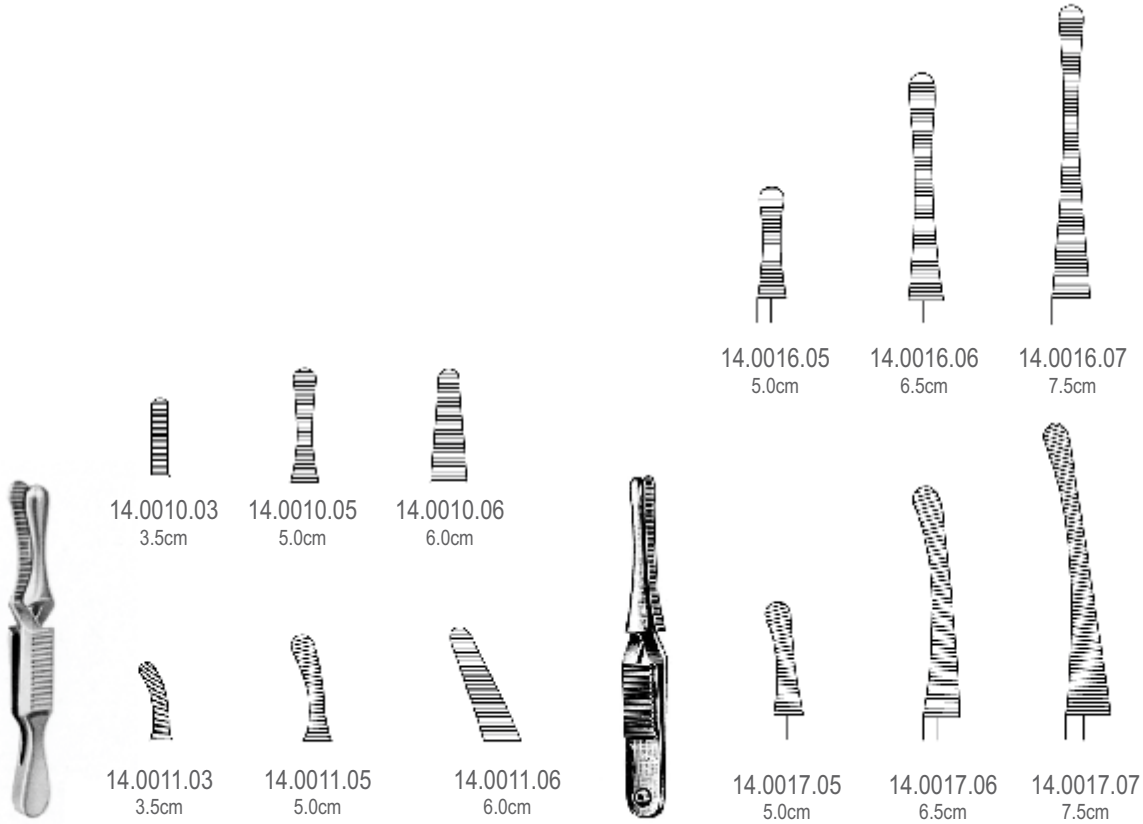

DIEFFENBACH

JOHNS-HOPKINS

ARTERY FORCEPS

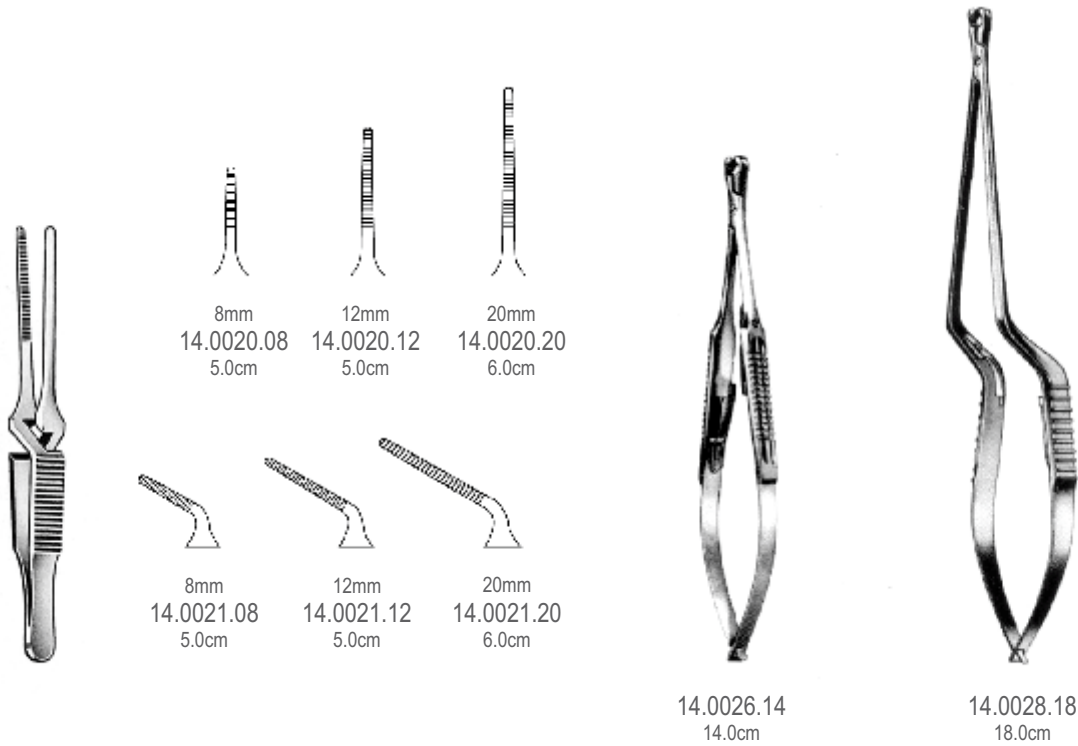

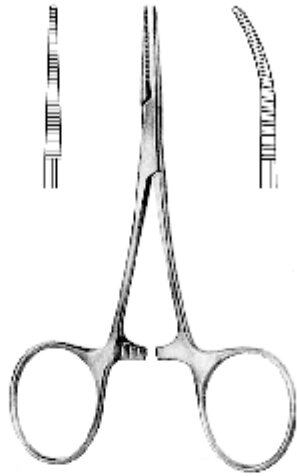

HARTMANN
14.0030.10 10.0cm 14.0031.10

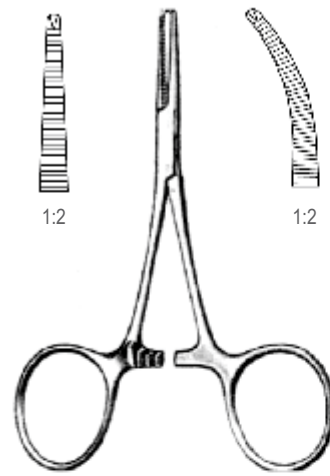

HARTMANN
14.0032.10 10.0cm 14.0033.10



CARREL
14.0040.08 8.5cm

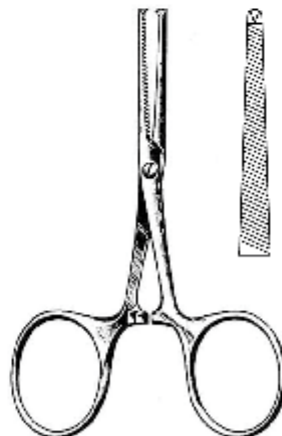

TERRIER
14.0044.08 8.5cm

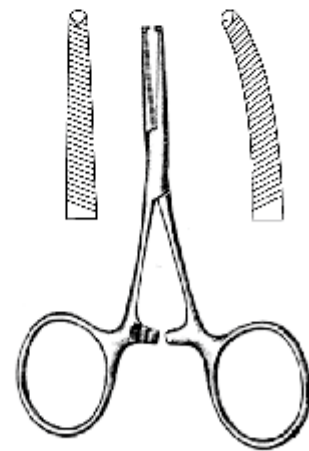

TERRIER
14.0048.09 9.0cm 14.0049.09

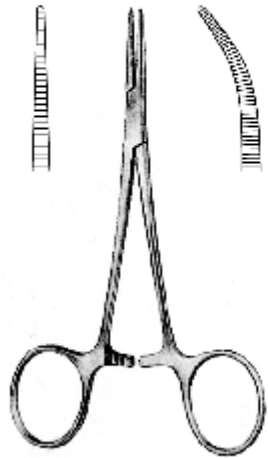

HALSTED-MOSQUITO
 14.0060.12 12.5cm 14.0061.12
 14.0060.14 14.0cm 14.0061.14

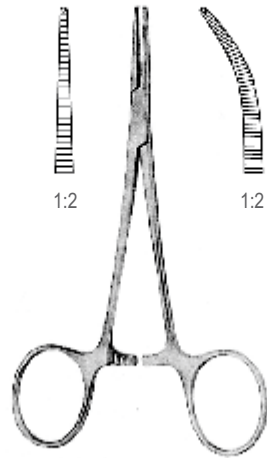

HALSTED-MOSQUITO
 14.0062.12 12.5cm 14.0063.12
 14.0062.14 14.0cm 14.0063.14

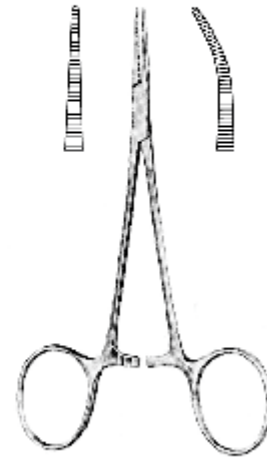

MICRO-MOSQUITO
 14.0070.10 10.0cm 14.0071.10
 14.0070.12 12.0cm 14.0071.12
 14.0070.14 14.0cm 14.0071.14

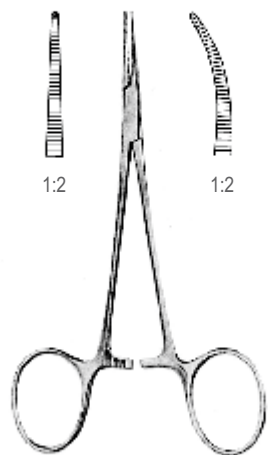

MICRO-MOSQUITO
 14.0072.10 10.0cm 14.0073.10
 14.0072.12 12.0cm 14.0073.12
 14.0072.14 14.0cm 14.0073.14

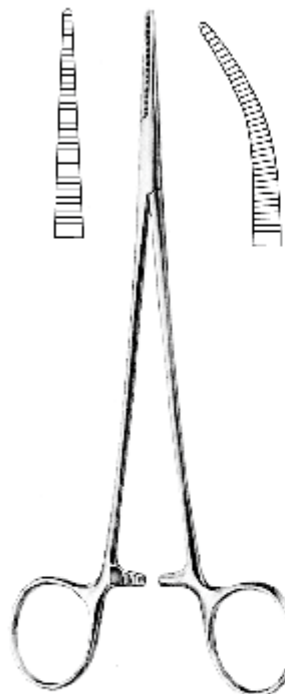

HALSTED-MOSQUITO
 14.0080.16 16.0cm 14.0081.16
 14.0080.18 18.0cm 14.0081.18
 14.0080.21 21.0cm 14.0081.21

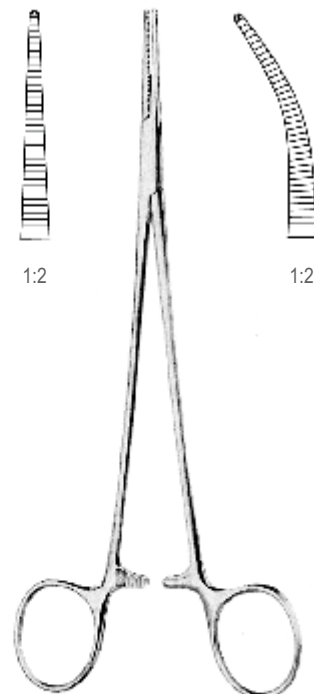

HALSTED-MOSQUITO
 14.0082.16 16.0cm 14.0083.16
 14.0082.18 18.0cm 14.0083.18
 14.0082.21 21.0cm 14.0083.21

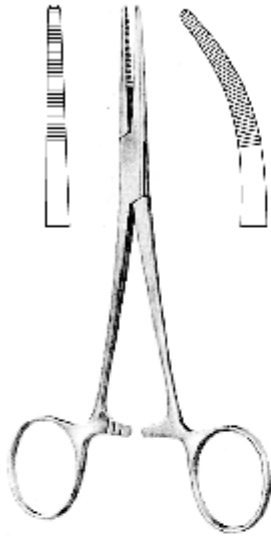

KELLY
14.0090.14 14.0cm 14.0091.14

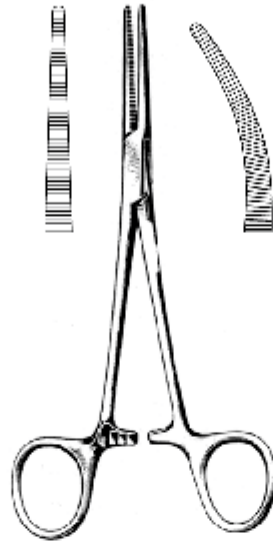

CRILE
14.0094.14 14.0cm 14.0095.14

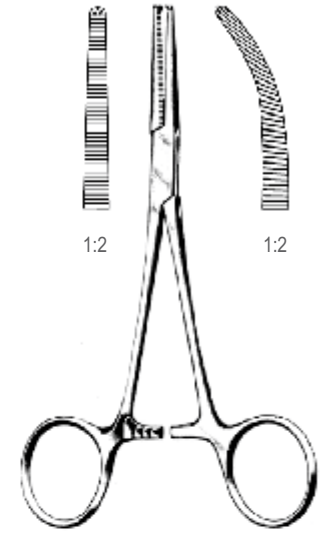

CRILE
14.0096.14 14.0cm 14.0097.14

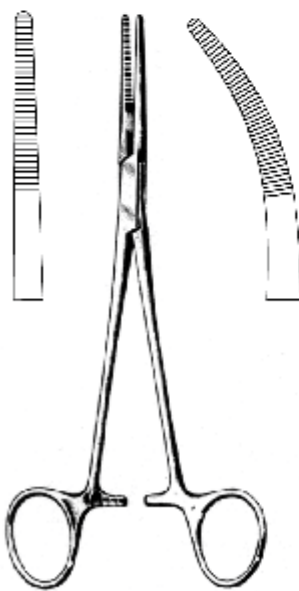

RANKIN-KELLY
14.0100.16 16.0cm 14.0101.16

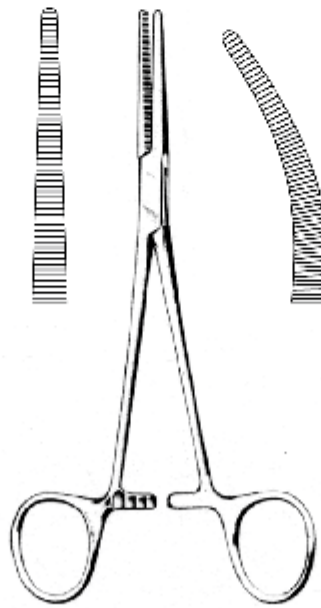

RANKIN-CRILE
14.0104.16 16.0cm 14.0105.16

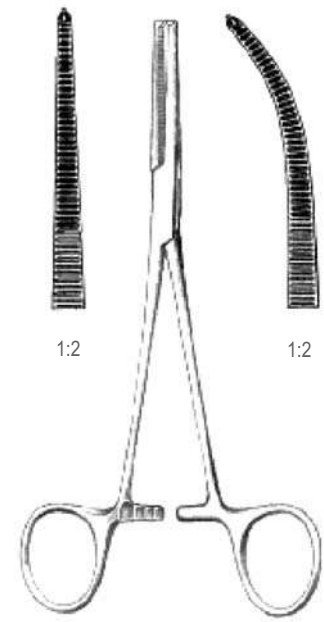

CRILE-RANKIN
14.0106.16 16.0cm 14.0107.16

Artery Forceps
 Arterienklemmen
 Pinzas hemostaticas
 Зажимы артериальные
 止血钳

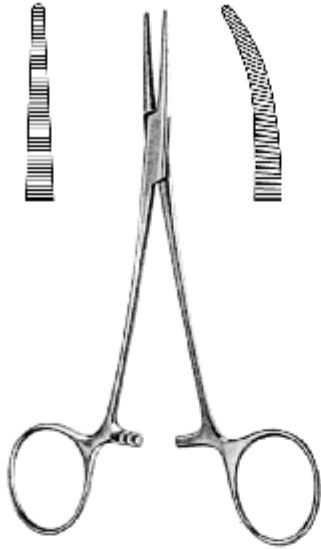

CRILE-DELICATE
 14.0110.14 14.0cm 14.0111.14

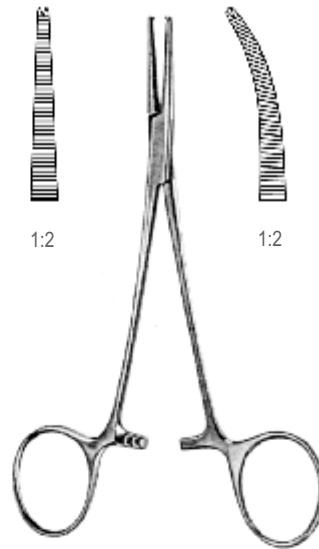

CRILE-DELICATE
 14.0116.14 14.0cm 14.0117.14

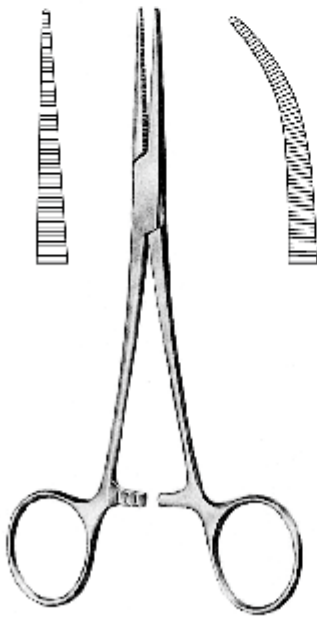

COLLER-CRILE
 14.0120.14 14.0cm 14.0121.14
 14.0120.16 16.0cm 14.0121.16

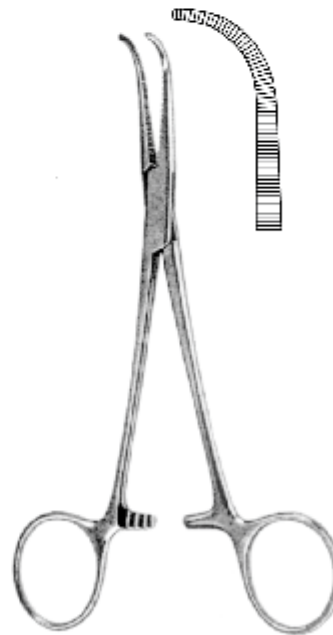

COLLER-CRILE
 14.0126.16 16.0cm

ARTERY FORCEPS

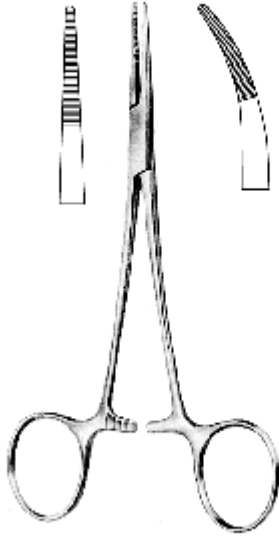

PROVIDENCE-HOSPITAL
14.0130.14 14.0cm 14.0131.14

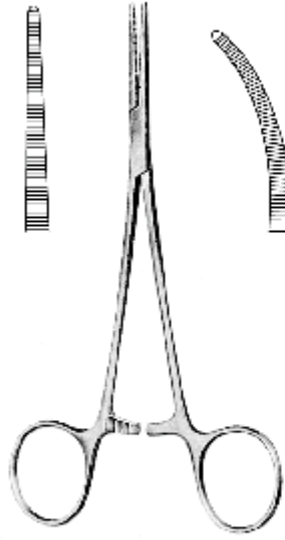

LERICHE
14.0136.15 15.0cm 14.0137.15

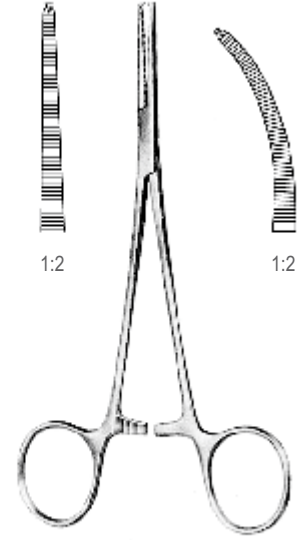

LERICHE
14.0138.15 15.0cm 14.0139.15

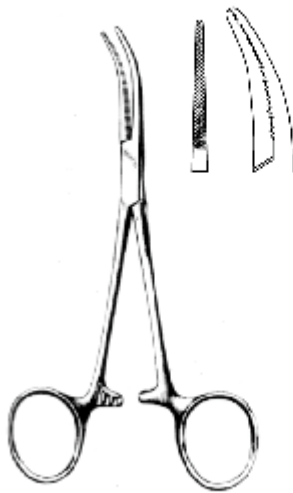

BABY-DANDY
14.0140.12 12.0cm

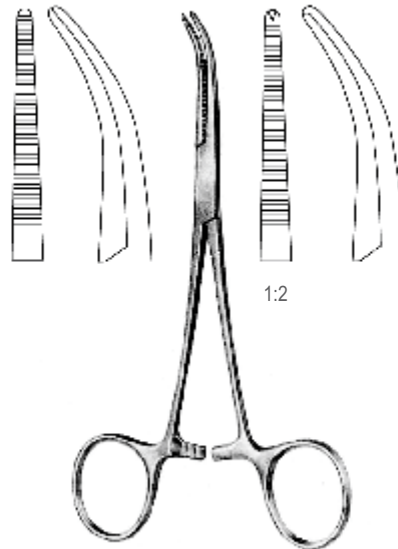

DANDY
14.0142.14 14.0cm 14.0144.14

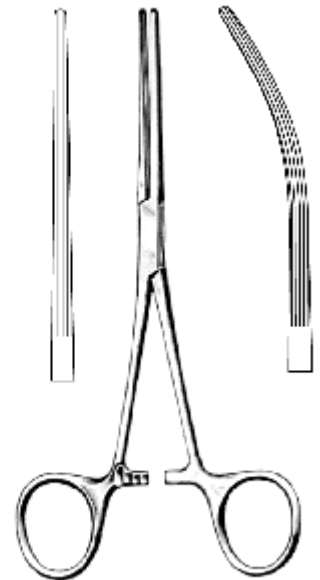

BAINBRIDGE
14.0150.15 15.0cm 14.0151.15
14.0150.18 18.5cm 14.0151.18

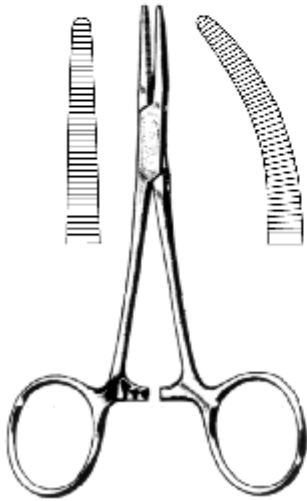

JONES
 14.0156.12 12.5cm 14.0157.12
 14.0156.15 15.0cm 14.0157.15

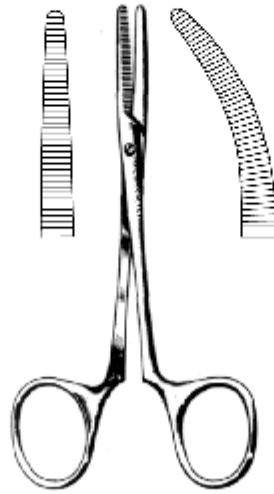

SPENCER-WELLS
 14.0160.12 12.5cm 14.0161.12
 14.0160.15 15.0cm 14.0161.15
 14.0160.18 18.0cm 14.0161.18
 14.0160.20 20.0cm 14.0161.20
 14.0160.23 23.0cm 14.0161.23

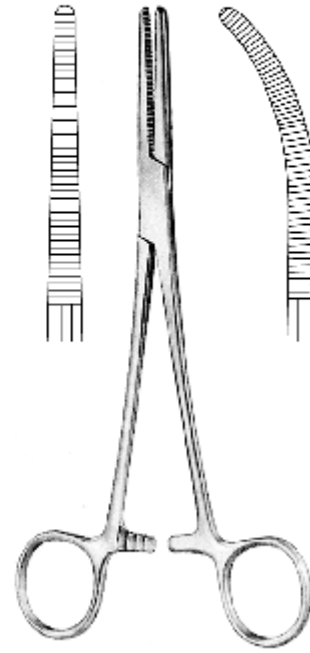

SPENCER-WELLS
 14.0162.13 13.0cm 14.0163.13
 14.0162.14 14.0cm 14.0163.14
 14.0162.15 15.0cm 14.0163.15
 14.0162.18 18.0cm 14.0163.18
 14.0162.20 20.0cm 14.0163.20
 14.0162.23 23.0cm 14.0163.23

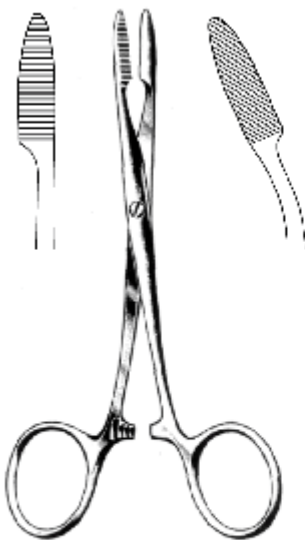

PEAN
 14.0170.12 12.5cm 14.0171.12
 14.0170.14 14.0cm 14.0171.14
 14.0170.16 16.0cm 14.0171.16

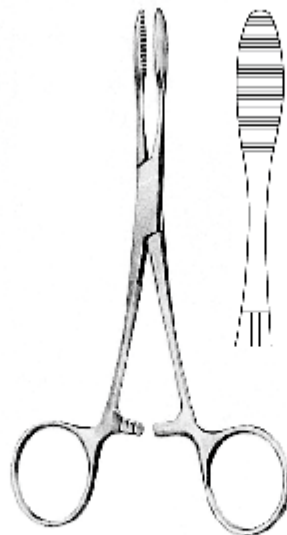

PEAN
 14.0172.12 12.5cm
 14.0172.14 14.0cm
 14.0172.16 16.0cm

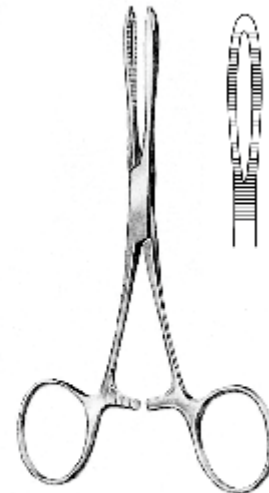

KROENLIEN
 14.0176.14 14.0cm 14.0178.14

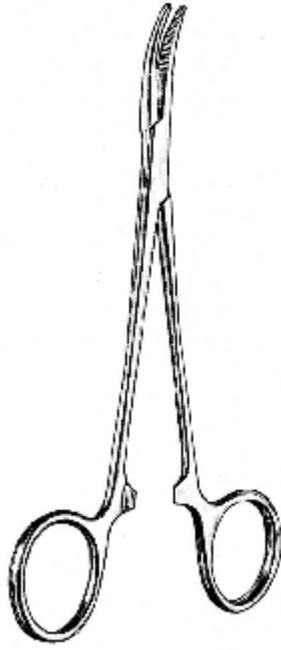

CAIRNS
14.0180.14 14.5cm 14.0181.14

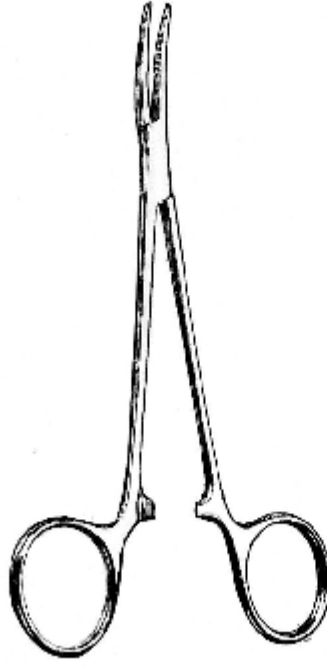

CUSHING
14.0186.14 14.0cm 14.0187.14

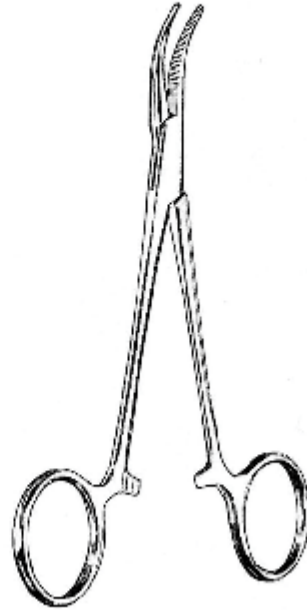

KILNER
14.0190.14 14.0cm 14.0191.14

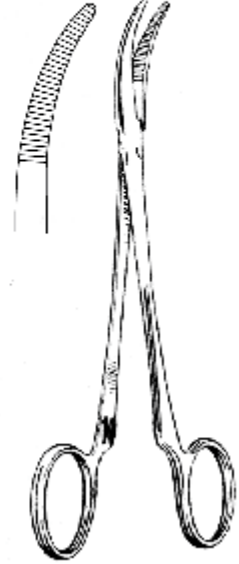

KELLY
14.0196.12 12.5cm

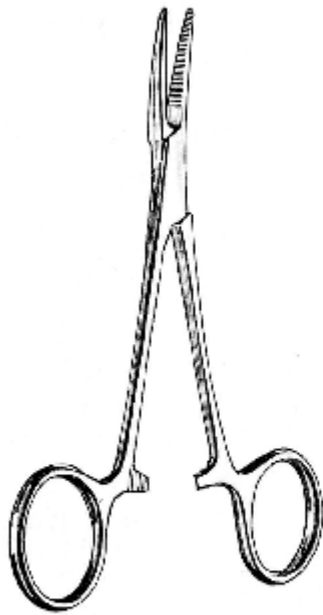

DUNHILL
14.0200.12 12.5cm 14.0201.12

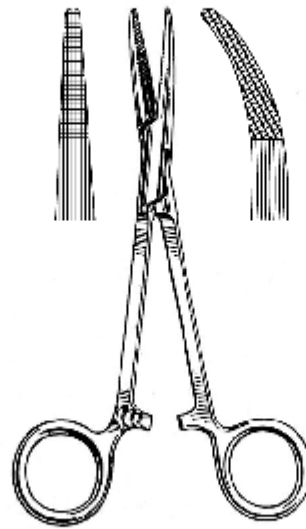

GREY-TURNER
14.0206.15 15.0cm 14.0207.15

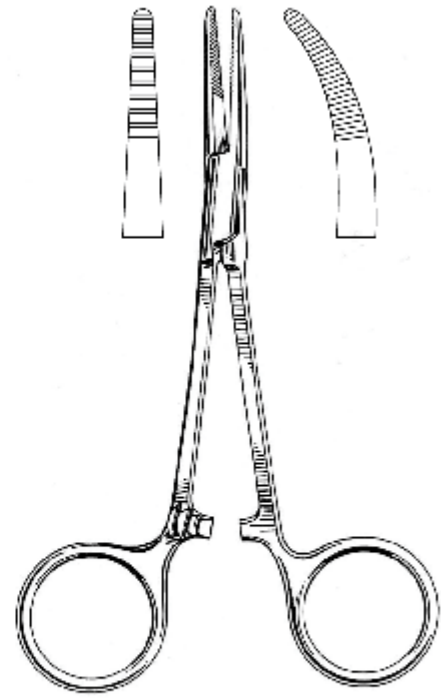

MOYNIHAN
14.0210.14 14.5cm 14.0211.14

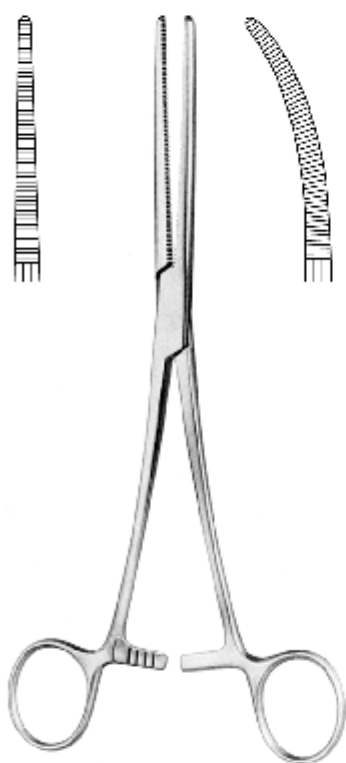

PEAN (ROCHESTER)

14.0220.13	13.0cm	14.0221.13
14.0220.14	14.0cm	14.0221.14
14.0220.16	16.0cm	14.0221.16
14.0220.18	18.0cm	14.0221.18
14.0220.20	20.0cm	14.0221.20
14.0220.22	22.0cm	14.0221.22
14.0220.24	24.0cm	14.0221.24
14.0220.26	26.0cm	14.0221.26
14.0220.28	28.0cm	14.0221.28
14.0220.30	30.0cm	14.0221.30

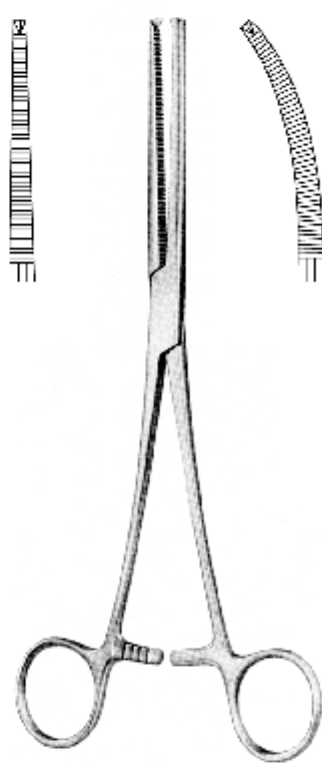

KOCHER (OCHSNER)

14.0226.13	13.0cm	14.0227.13
14.0226.14	14.0cm	14.0227.14
14.0226.16	16.0cm	14.0227.16
14.0226.18	18.0cm	14.0227.18
14.0226.20	20.0cm	14.0227.20
14.0226.22	22.0cm	14.0227.22
14.0226.24	24.0cm	14.0227.24
14.0226.26	26.0cm	14.0227.26
14.0226.28	28.0cm	14.0227.28
14.0226.30	30.0cm	14.0227.30

ARTERY FORCEPS

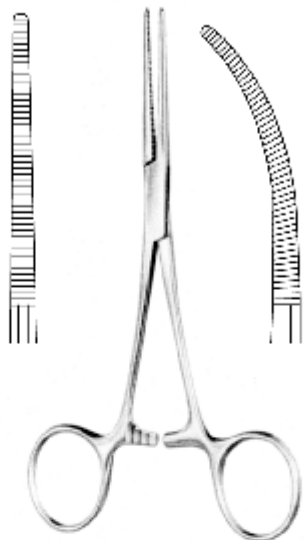

PEAN (DELICATE)

14.0230.13 13.0cm 14.0231.13
14.0230.14 14.0cm 14.0231.14
14.0230.16 16.0cm 14.0231.16

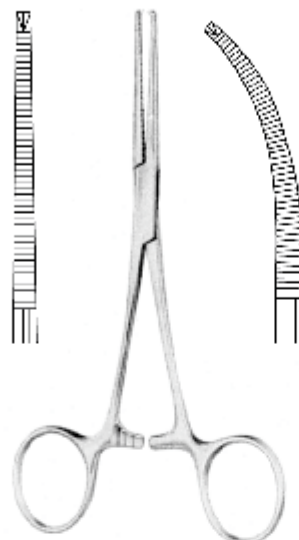

KOCHER (DELICATE)

14.0236.13 13.0cm 14.0237.13
14.0236.14 14.0cm 14.0237.14
14.0236.16 16.0cm 14.0237.16

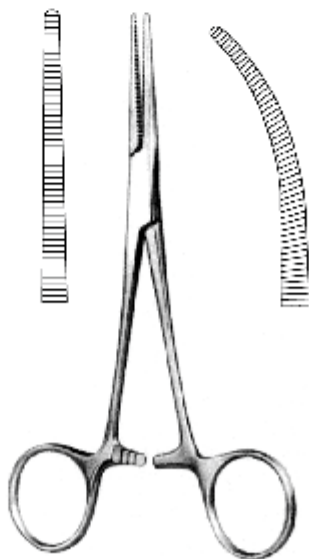

PEAN-NIPPON

14.0240.14 14.5cm 14.0241.14
14.0240.16 16.0cm 14.0241.16
14.0240.18 18.0cm 14.0241.18

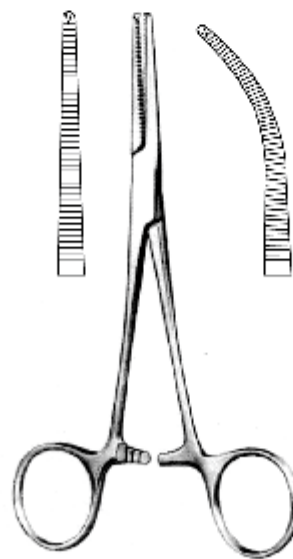

KOCHER-NIPPON

14.0246.14 14.5cm 14.0247.14
14.0246.16 16.0cm 14.0247.16
14.0246.18 18.0cm 14.0247.18

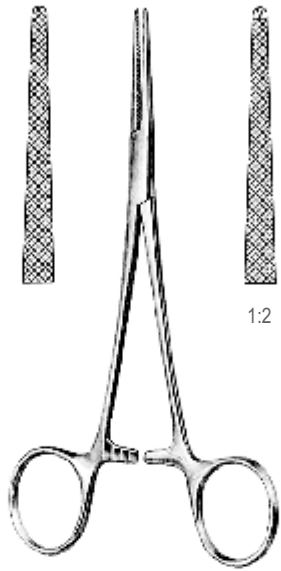

LOVELACE
 14.0250.15 15.5cm 14.0252.15

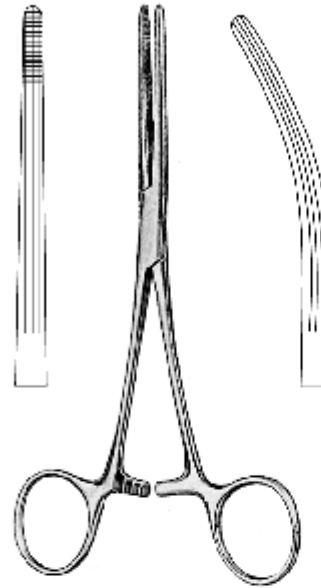

ROCHESTER-CARMALT
 14.0256.16 16.0cm 14.0257.16
 14.0256.20 20.0cm 14.0257.20

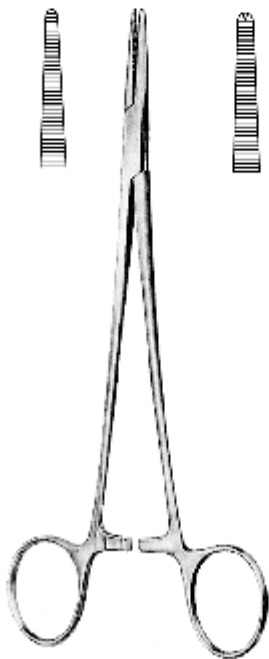

HOSEMANN
 14.0260.21 21.0cm 14.0262.21

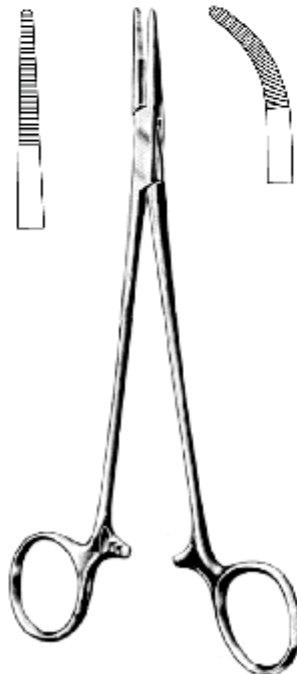

ADSON
 14.0270.18 18.5cm 14.0271.18

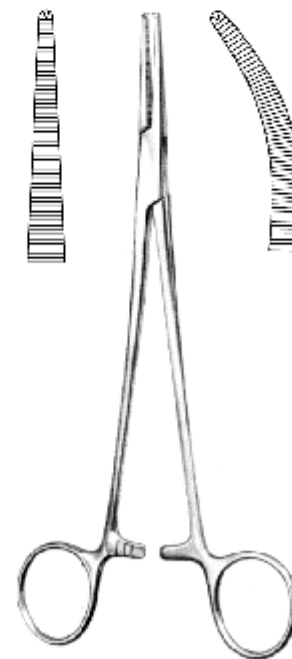

ADSON
 14.0272.18 18.5cm 14.0273.18

ARTERY FORCEPS

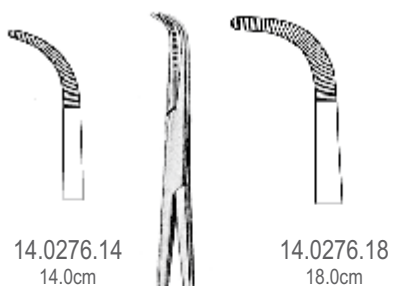

BABY-ADSON



BABY-OVERHOLT
14.0290.13 13.5cm

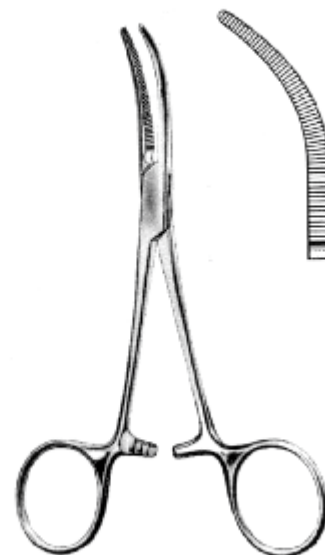

MIXTER BABY
14.0292.14 14.0cm

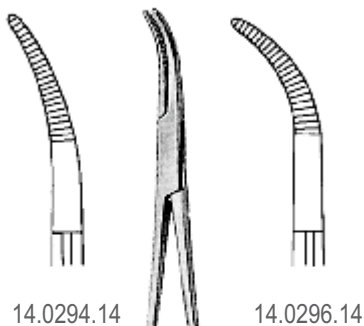

BABY-MIXTER
14.0cm



BABY-MIXTER
14.0298.18 18.0cm

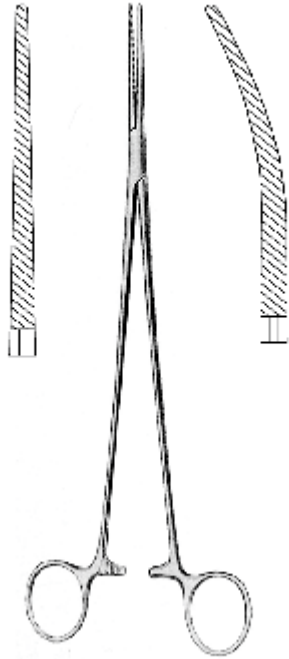

BENGOLEA

14.0300.20 20.0cm 14.0301.20
 14.0300.24 24.0cm 14.0301.24
 14.0300.26 26.0cm 14.0301.26

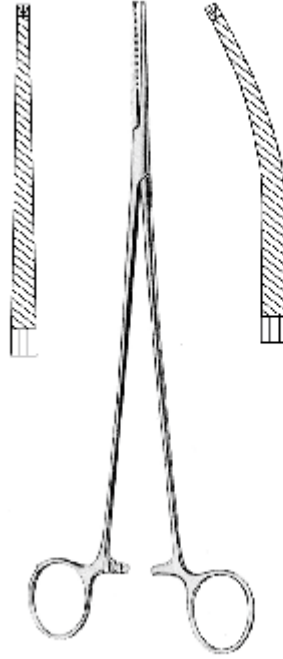

BENGOLEA

14.0302.20 20.0cm 14.0303.20
 14.0302.24 24.0cm 14.0303.24
 14.0302.26 26.0cm 14.0303.26

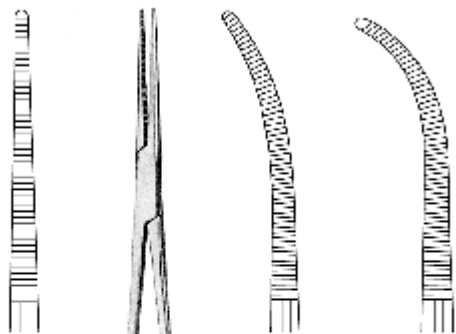

14.0310.20

14.0311.20

14.0313.20



HEISS
 20.0cm

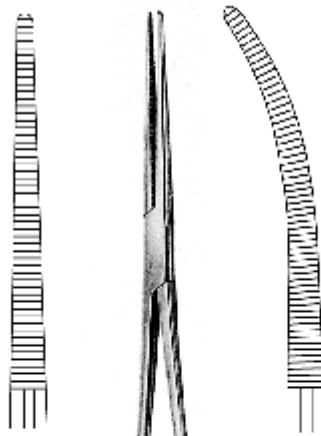

14.0316.22

14.0317.22



ROBERTS
 22.0cm

ARTERY FORCEPS

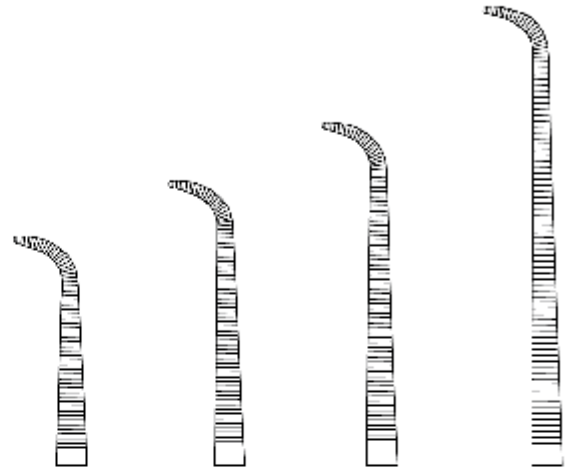

MINI-GEMINI	14.0320.18 18.0cm	14.0320.22 22.0cm	14.0320.25 25.0cm	14.0320.28 28.0cm
--------------------	----------------------	----------------------	----------------------	----------------------

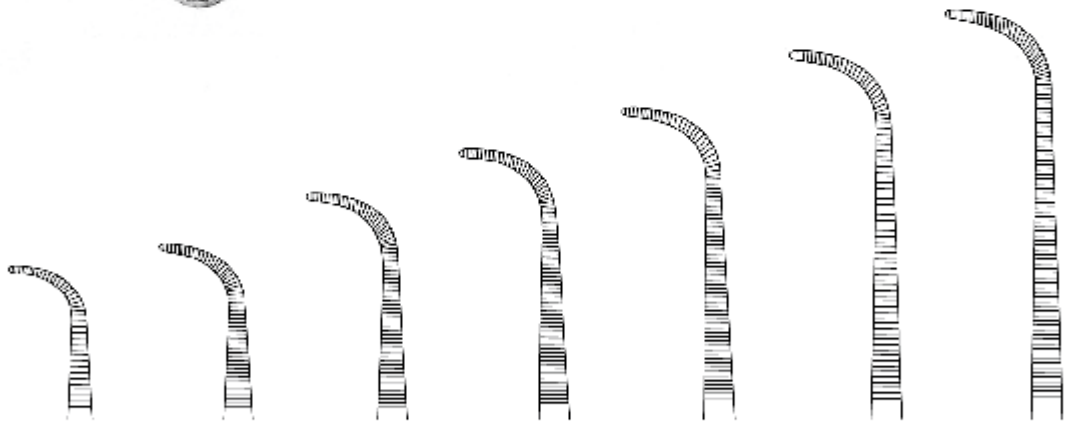



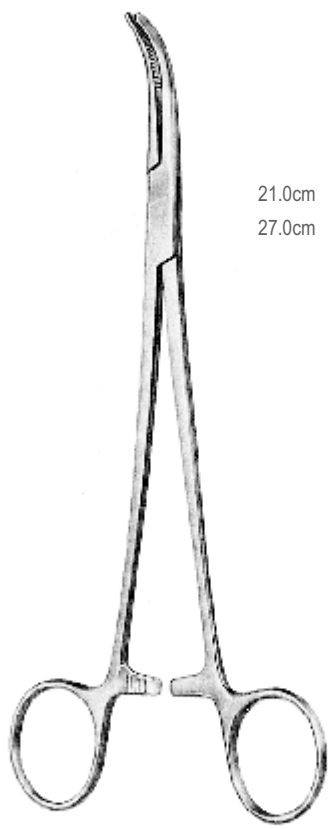

GEMINI	14.0322.13 13.0cm	14.0322.16 16.0cm	14.0322.18 18.0cm	14.0322.20 20.0cm	14.0322.23 23.0cm	14.0322.25 25.0cm	14.0322.28 28.0cm
---------------	----------------------	----------------------	----------------------	----------------------	----------------------	----------------------	----------------------

Artery Forceps
 Arterienklemmen
 Pinzas hemostaticas
 Зажимы артериальные
 动脉钳

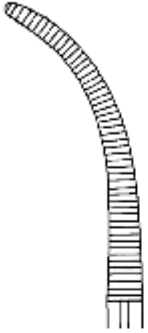
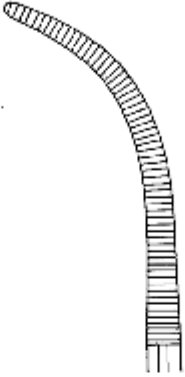
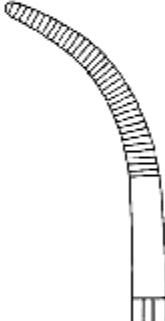
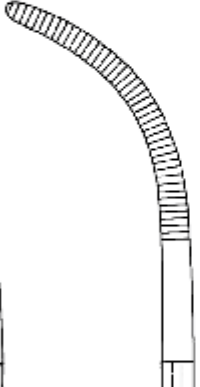

OVERHOLT-GEISSENDOERFER

				
21.0cm	14.0331.21	14.0332.21	14.0333.21	14.0334.21
27.0cm	14.0331.27	14.0332.27	14.0333.27	14.0334.27
				
21.0cm	14.0335.21	14.0336.21	14.0337.21	
27.0cm	14.0335.27	14.0336.27	14.0337.27	

ARTERY FORCEPS



OVERHOLT

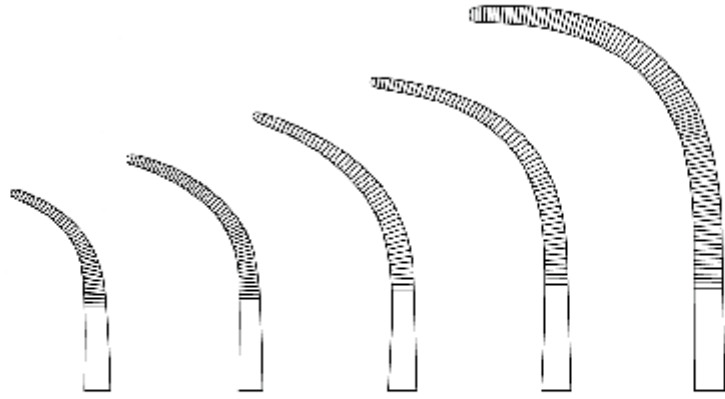

14.0340.01 18.5cm
 14.0340.02 20.5cm
 14.0340.03 21.0cm
 14.0340.04 21.5cm
 14.0340.05 24.0cm

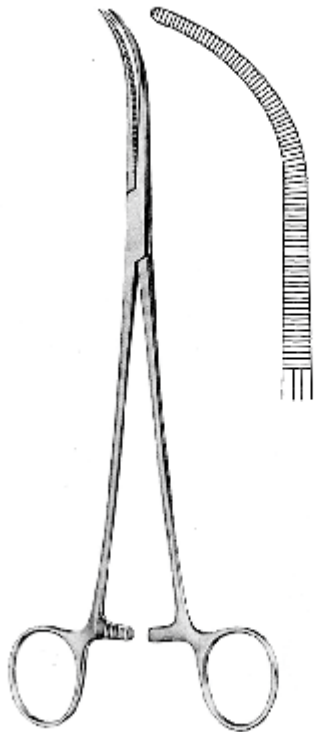

OVERHOLT-MIXTER
 14.0342.21 21.0cm

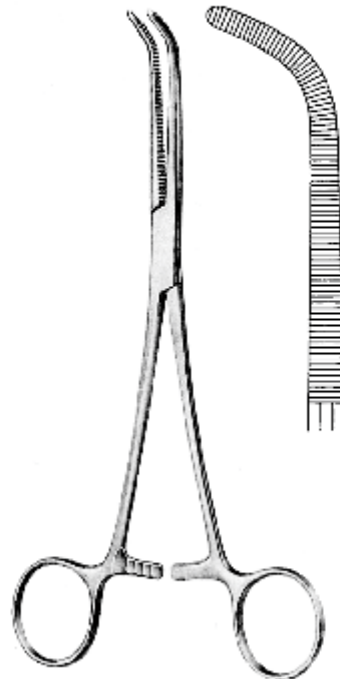

MIXTER
 14.0344.22 22.0cm

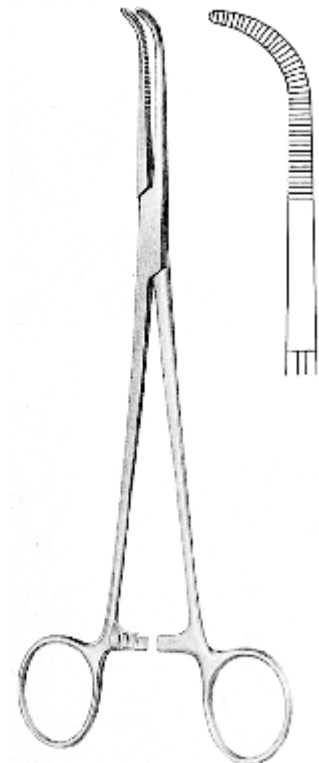

MIXTER
 14.0346.23 23.0cm

Artery Forceps, Dissecting and ligature Forceps
 Arterienklemmen, Präparier- und Ligaturklemmen
 Pinzas hemostáticas, pinzas para preparaciones y ligaduras
 Зажимы артериальные
 分离结扎钳



ARTERY FORCEPS

KELLY

19.0 cm 14.0350.19 14.0351.19 14.0353.19
 22.0 cm 14.0350.22 14.0351.22 14.0353.22
 24.0 cm 14.0350.24 14.0351.24 14.0353.24

MEEKER

14.0356.27 27.5 cm

LAWRENCE

14.0358.27 27.5 cm

ARTERY FORCEPS

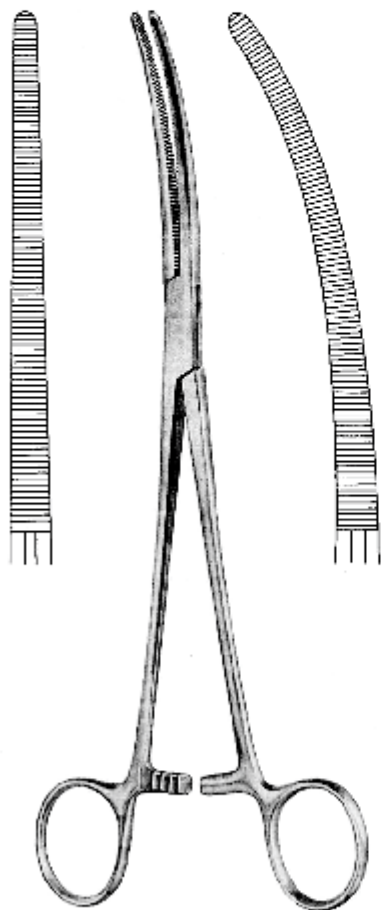

SAROT
14.0360.24 24.0cm 14.0361.24

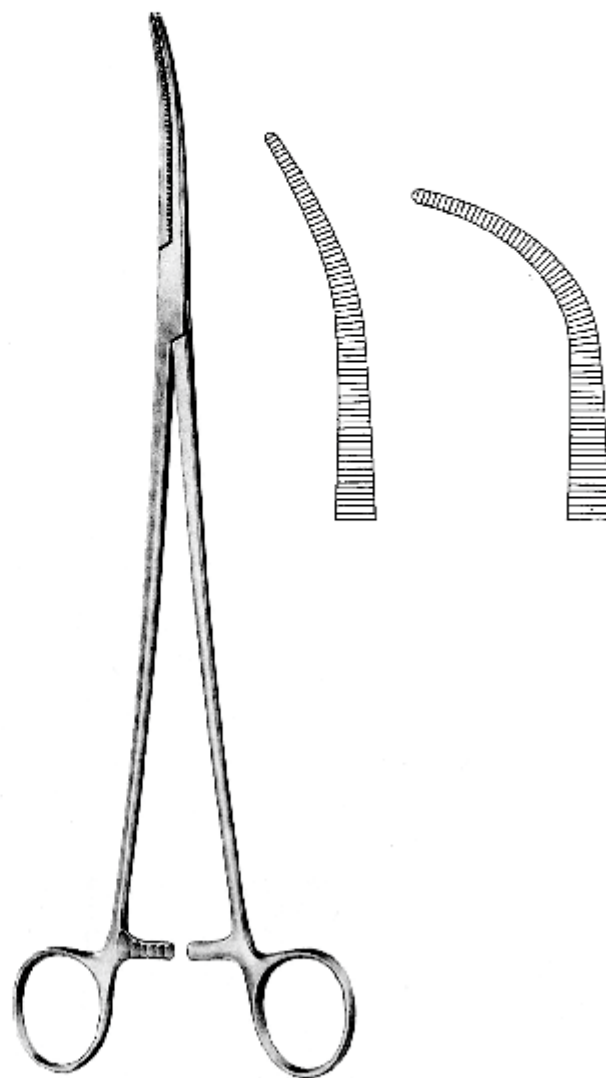

ZENKER
14.0366.01 29.5cm 14.0366.02

Artery Forceps, Dissecting and ligature Forceps
 Arterienklemmen, Präparier- und Ligaturklemmen
 Pinzas hemostáticas, pinzas para preparaciones y ligaduras
 Зажимы лигатурные
 扁桃体止血钳、分离结扎钳

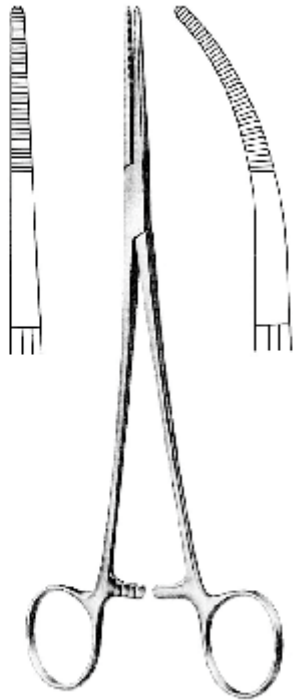

TOENNIS

14.0370.21 21.0cm 14.0371.21
 14.0370.26 26.0cm 14.0371.26

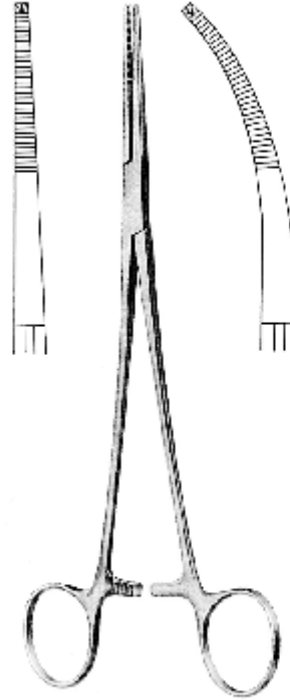

TOENNIS

14.0372.21 21.0cm 14.0373.21
 14.0372.26 26.0cm 14.0373.26

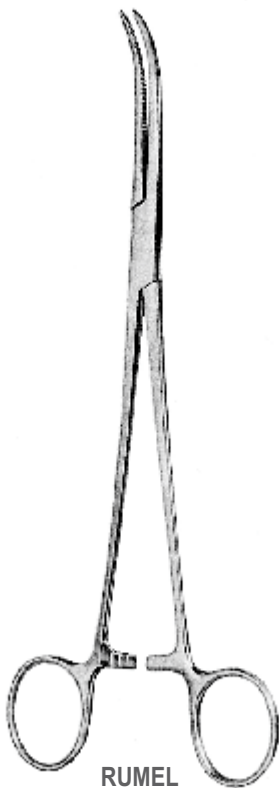

RUMEL
 23.0cm



14.0380.01



14.0380.02



14.0380.03



14.0380.04

14.0380.05

ARTERY FORCEPS

ARTERY FORCEPS

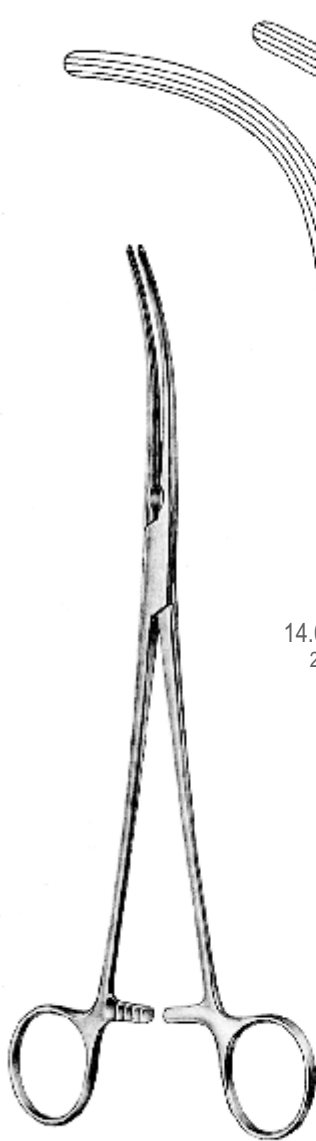

CRAFOORD-SELLORS

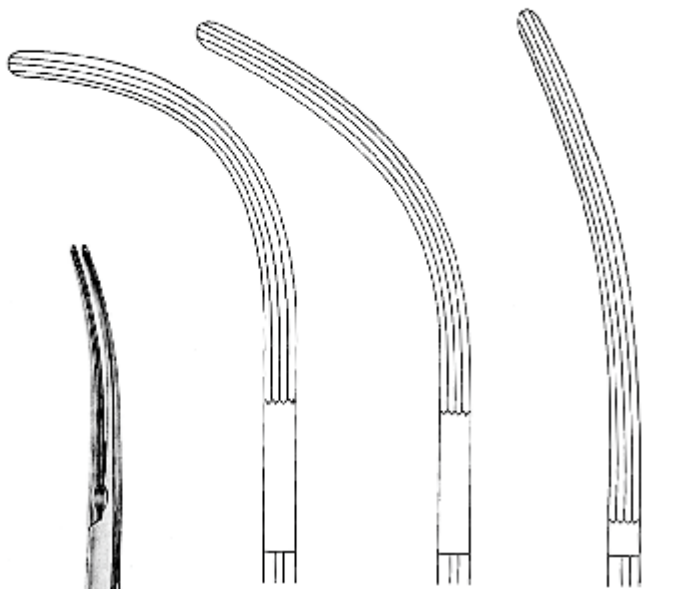

14.0386.01
22.0cm

14.0386.02
23.0cm

14.0386.03
24.0cm

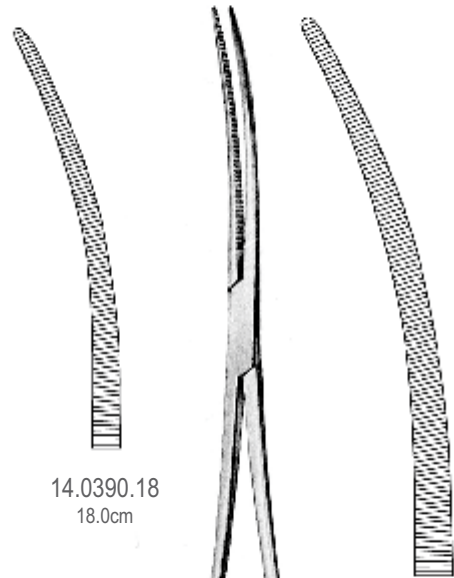

14.0390.18
18.0cm

14.0390.24
24.0cm

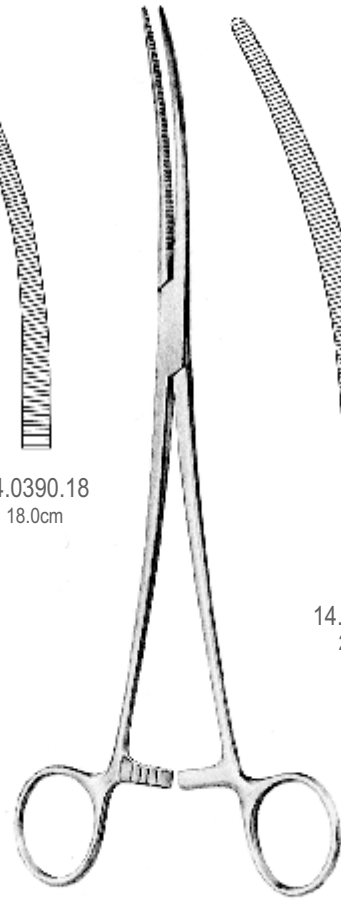

CRAFOORD

Artery Forceps, Gall Duct and Kidney Pedicle Clamp Forceps
 Arterien-Gallenkanal-und Nierenstielklemmen
 Pinzas-gallenkanal-und nierenstielklemmen
 Зажимы для желчных протоков
 动脉钳，胆管和肾蒂钳钳

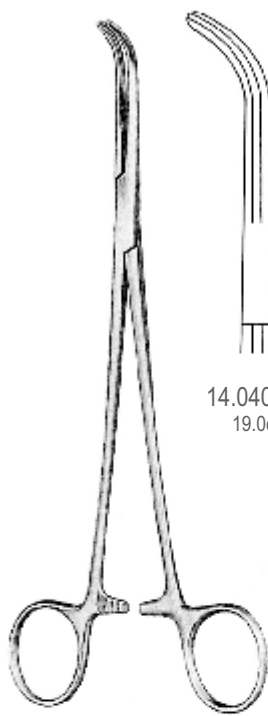

14.0400.19 19.0cm
 14.0400.23 23.0cm

LAHEY

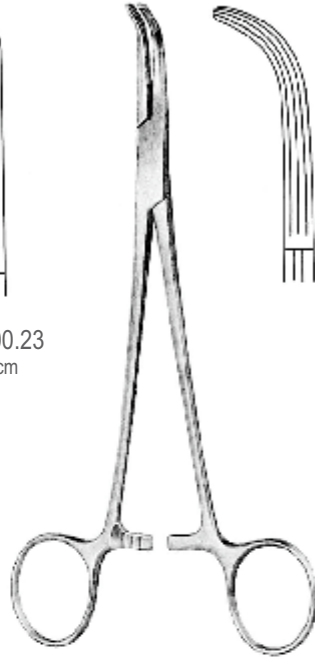

LOWER
 14.0406.18 18.0cm

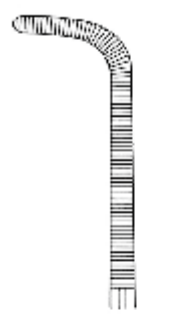

14.0410.21
 21.0cm

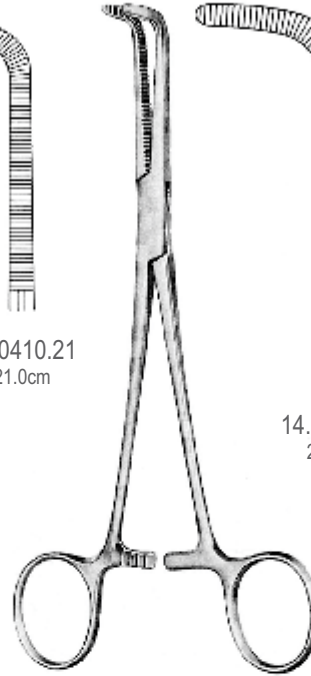

WICKSTRÖM

14.0410.24
 24.0cm

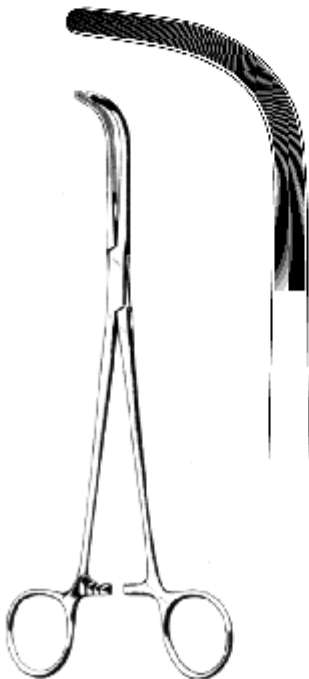

McQUIGG-MIXTER
 14.0416.22 22.0cm

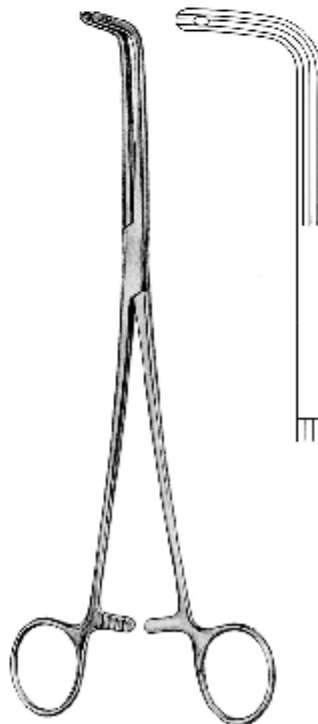

FINOCHIETTO
 14.0420.24 24.0cm

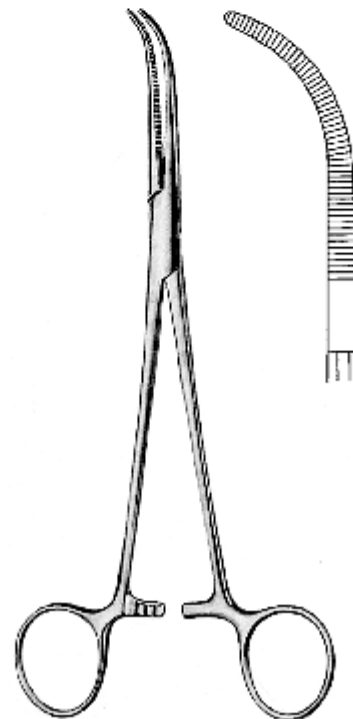

JOHNS HOPKINS
 14.0426.20 20.0cm

ARTERY FORCEPS

Artery Forceps, Gall Duct and Kidney Pedical Clamp Forceps

Arterien-Gallenkanal-und Nierenstielklemmen

Pinzas-gallenkanal-und nierenstielklemmen

Зажимы для желчных протоков

动脉钳，胆管和肾蒂钳钳

ARTERY FORCEPS

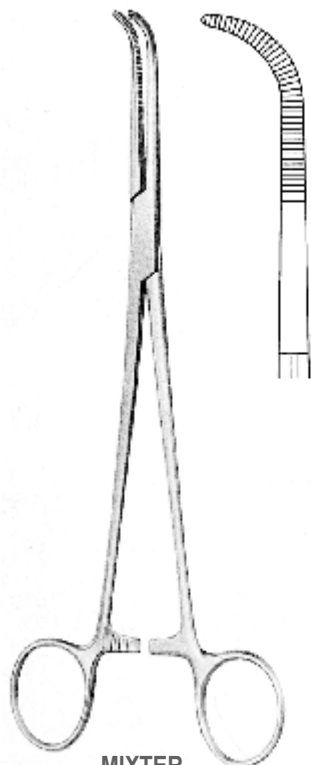

MIXTER

14.0430.15 15.0cm
14.0430.19 19.0cm

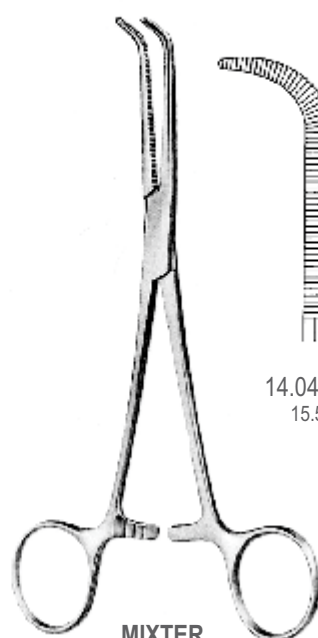

MIXTER

14.0432.15
15.5cm

14.0432.18
18.0cm

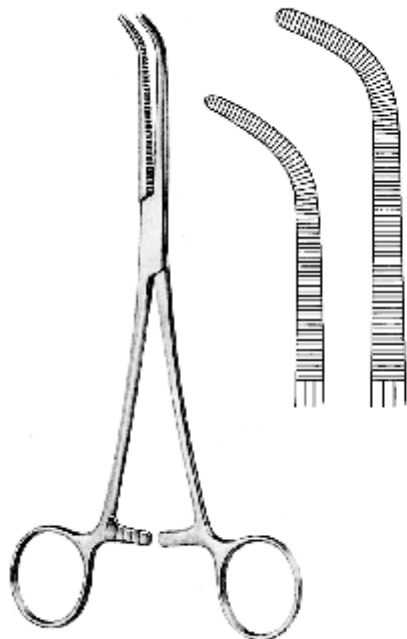

MIXTER-O'SHAUGHNESSY

14.0434.18 18.0cm
14.0434.22 22.0cm

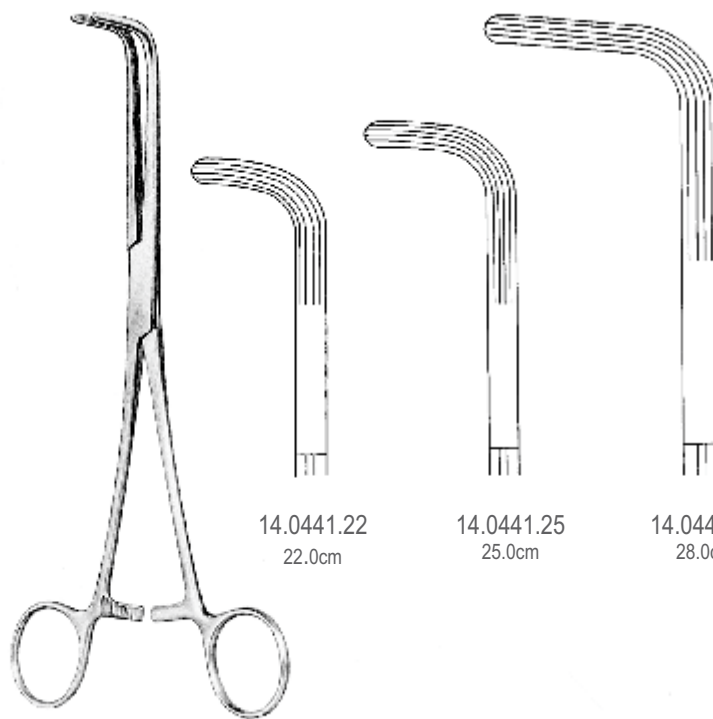

MIXTER

14.0441.22
22.0cm

14.0441.25
25.0cm

14.0441.28
28.0cm

Kidney Pedicle Clamps Forceps
 Nierenstielklemmen
 Pinzas-clamps para pedunculos renales
 Зажимы для почечной ножки
 肾蒂钳

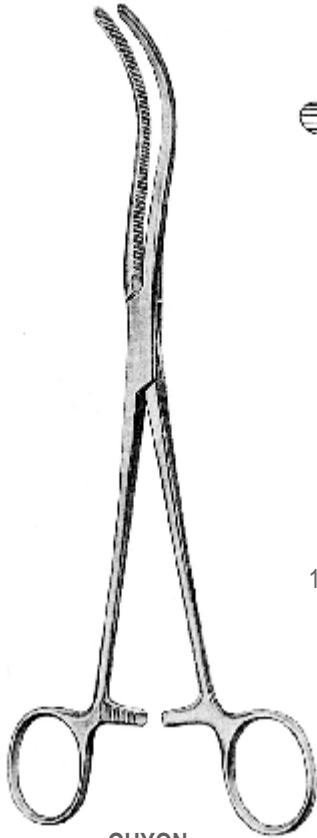

GUYON

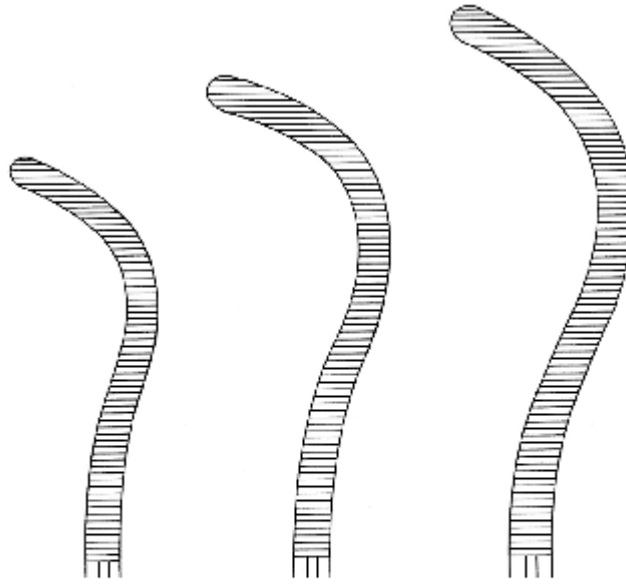

14.0450.20 20.0cm 14.0450.22 22.0cm 14.0450.24 24.0cm

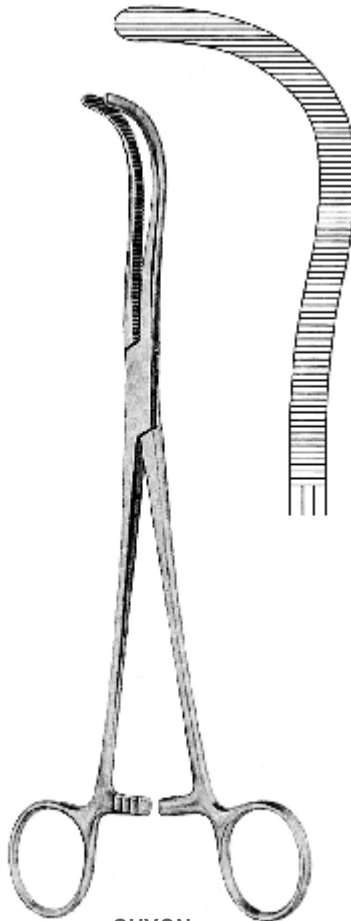

GUYON

14.0452.23 23.0cm

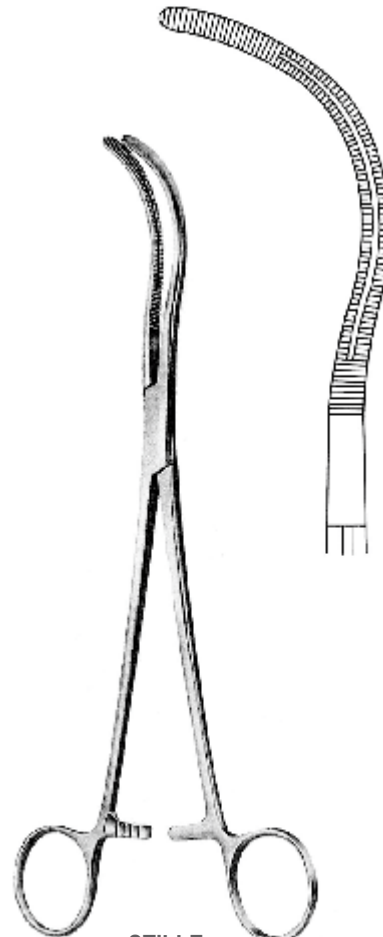

STILLE

14.0454.23 23.0cm

ARTERY FORCEPS

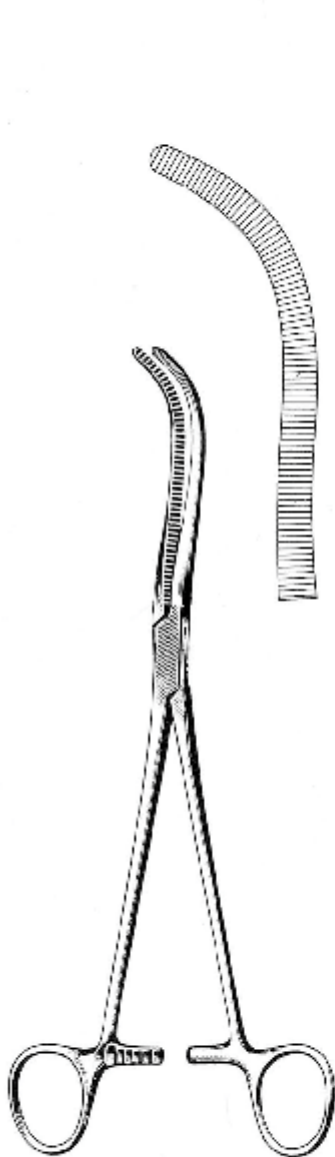

MAYO
14.0456.23 23.0cm

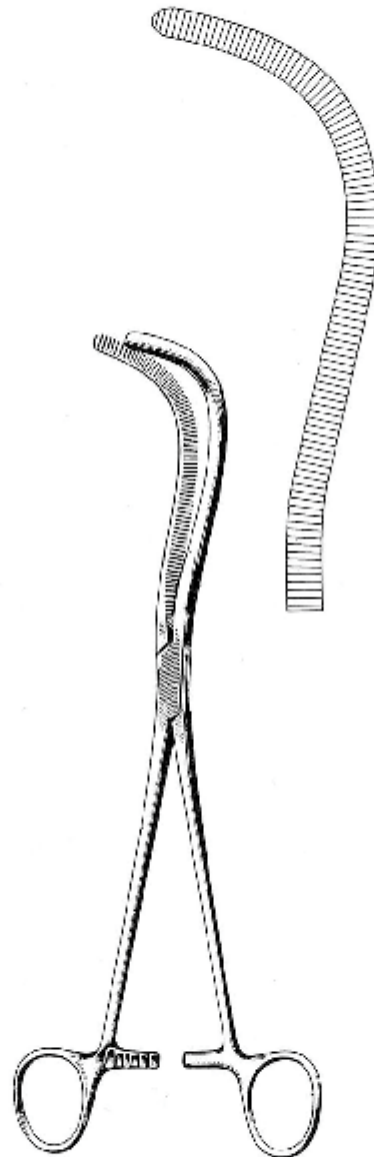

MAYO-GUYON
14.0458.23 23.0cm

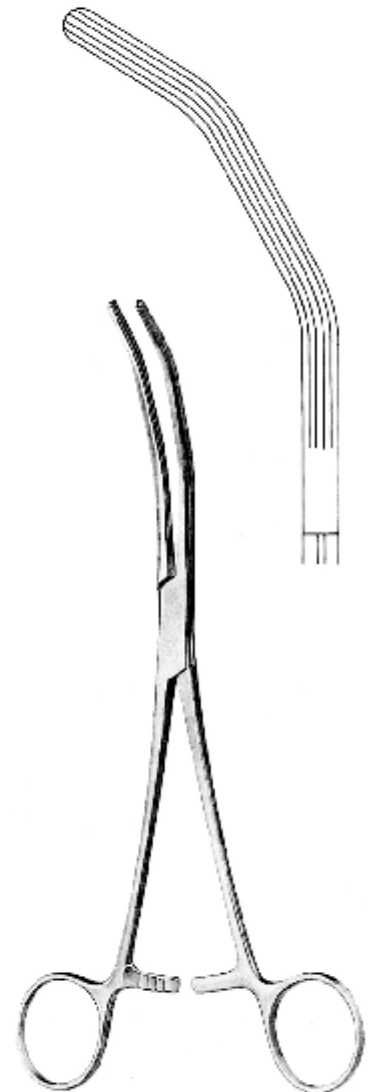

HERRICK
14.0460.23 23.0cm

Gall Duct Forceps
Gallenkanalklemmen
Pinzas para conducto biliar
Зажимы для желчных протоков
胆囊钳

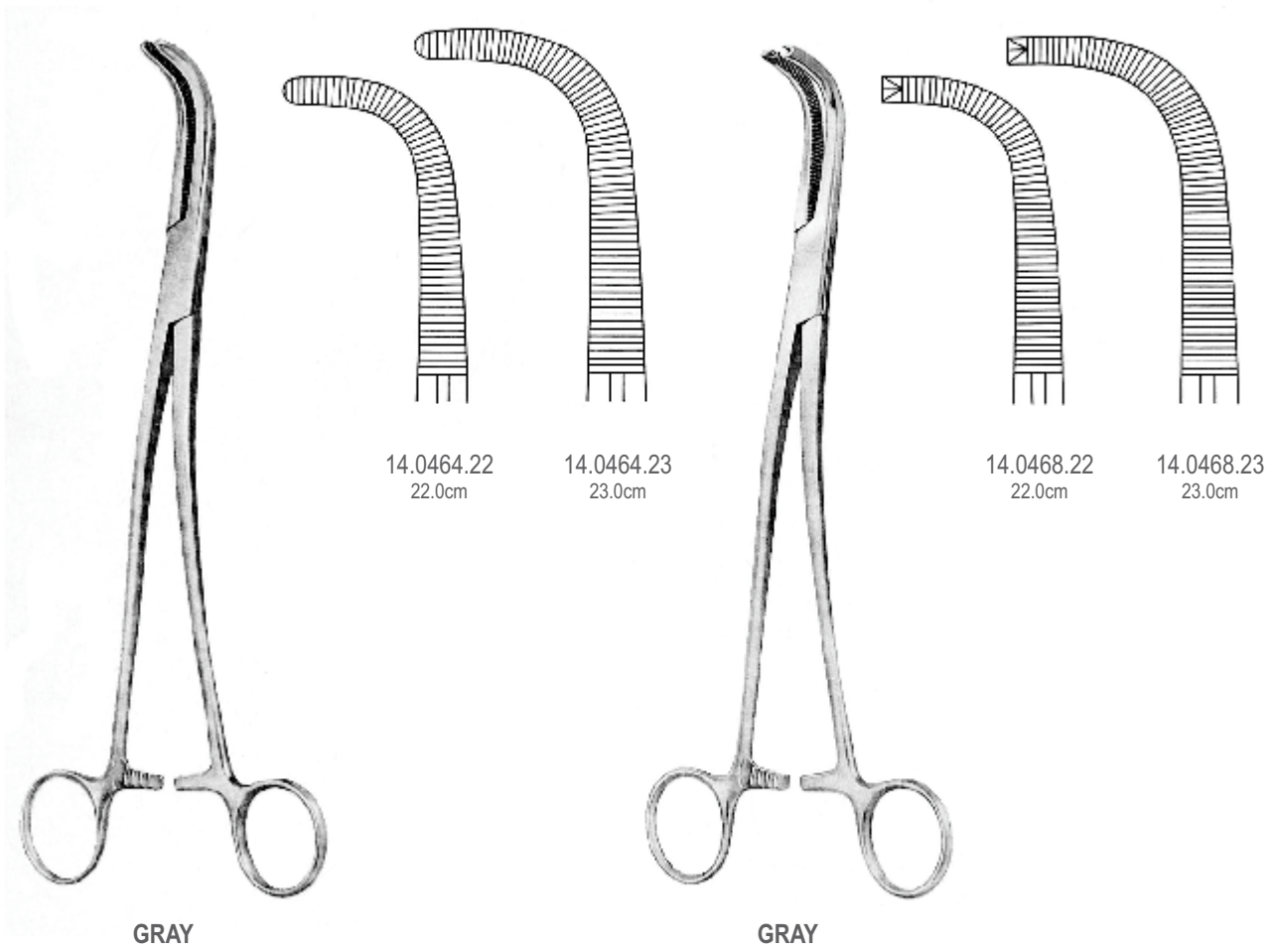

ARTERY FORCEPS



DESJARDINS
14.0470.21 21.0cm

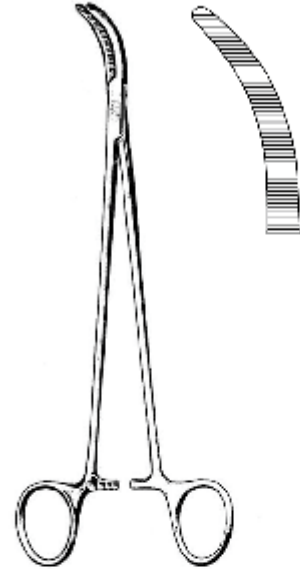

DESJARDINS
14.0472.21 21.0cm

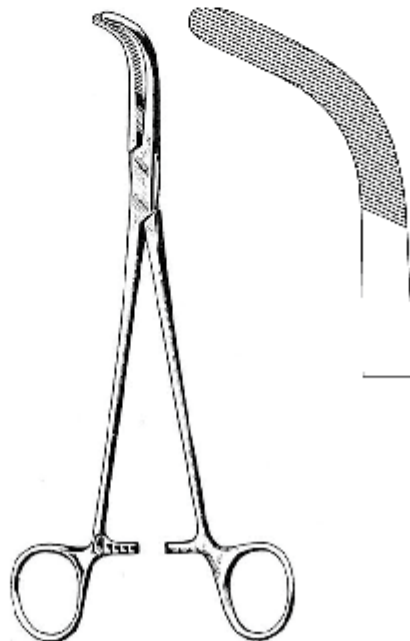

CRILE
14.0476.20 20.0cm

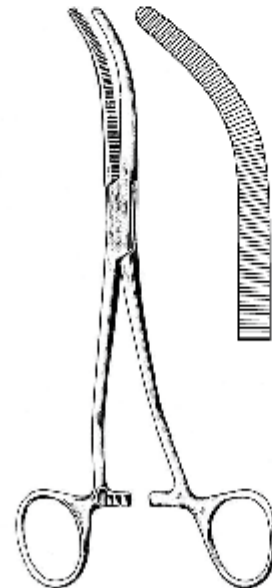

DEAN-SHALLCROSS
14.0480.18 18.0cm

Tangential Forceps, Kidney Pedicle Clamps Forceps
 Tangentialklemmen, Nierenstielklemmen
 Pinzas tangenciales, pinzas-clamps para pedunculos Renales
 Зажимы для почечной ножки
 切钳，肾蒂钳钳



ATRAUMA

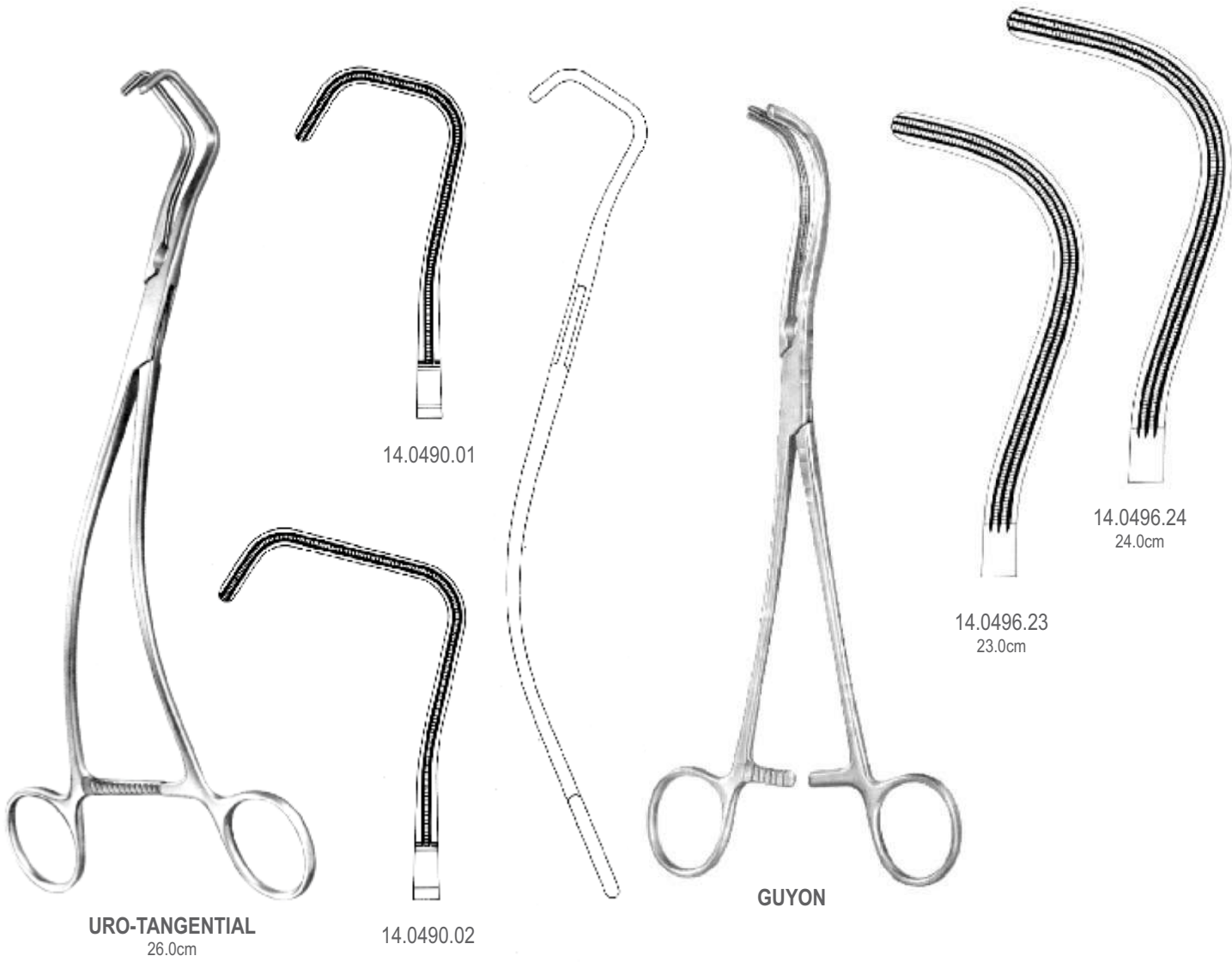



BABY-MIKULICZ
14.0500.14 14.0cm

MIKULICZ
14.0500.18 18.0cm

MIKULICZ
14.0500.20 20.0cm

MIKULICZ
14.0502.20 20.0cm

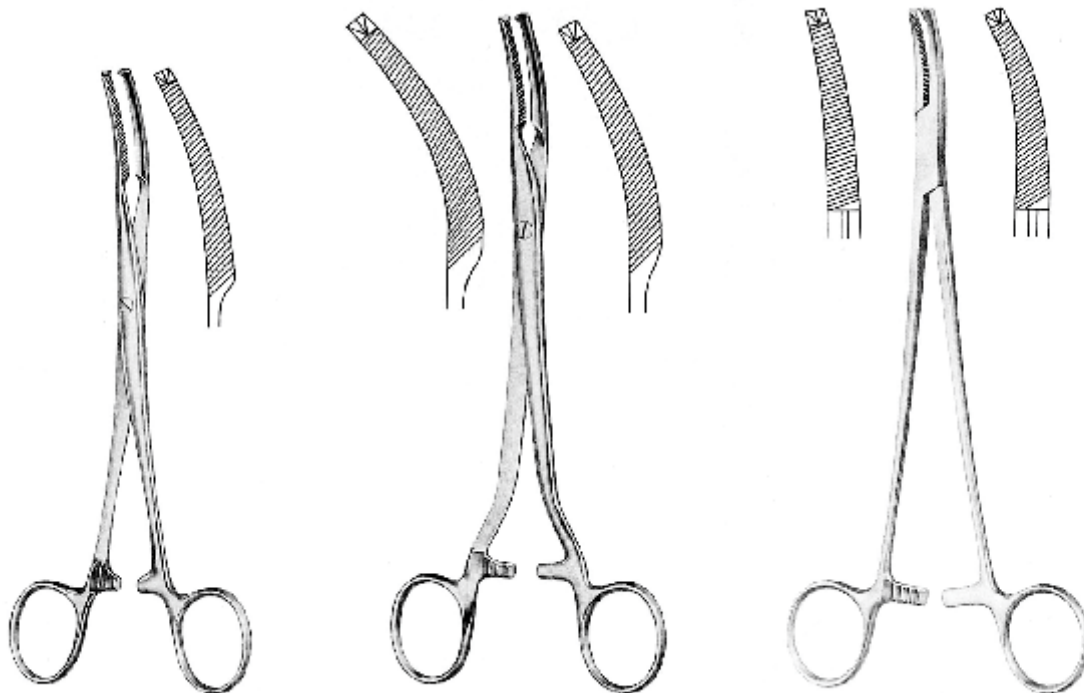

MIKULICZ
14.0504.18 18.0cm

MIKULICZ
14.0506.20 20.0cm 14.0508.20

FAURE
14.0512.20 20.0cm 14.0514.20

Hysterectomy Forceps
 Hysterektomieklemmen
 Pinzas Para Histerectomia
 Зажимы для гистерэктомии
 子宫切除术钳

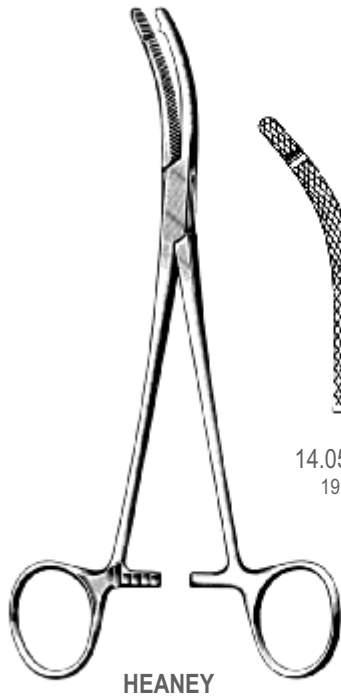

HEANEY



14.0520.19
19.5cm



14.0520.21
21.0cm



14.0520.23
23.0cm



14.0522.19
19.5cm



14.0522.21
21.0cm



14.0522.23
23.0cm

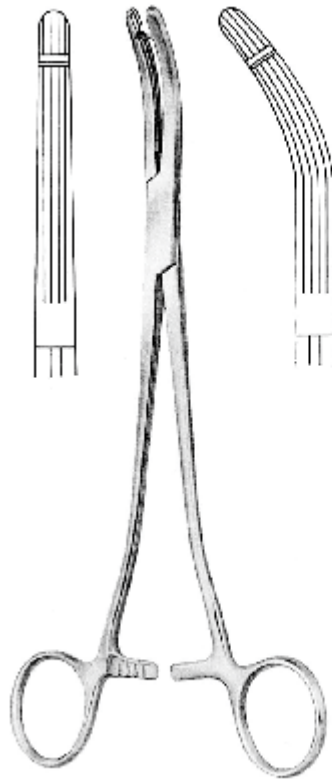

HEANEY-BALLENTINE
14.0526.21 21.0cm 14.0527.21

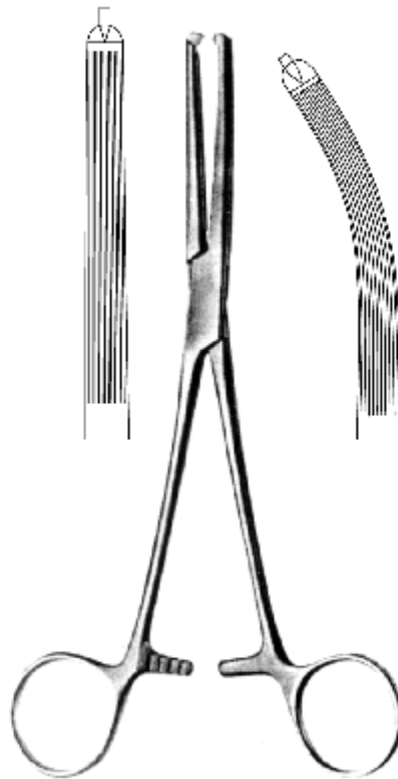

GWILLIAM
14.0530.20 20.0cm 14.0531.20

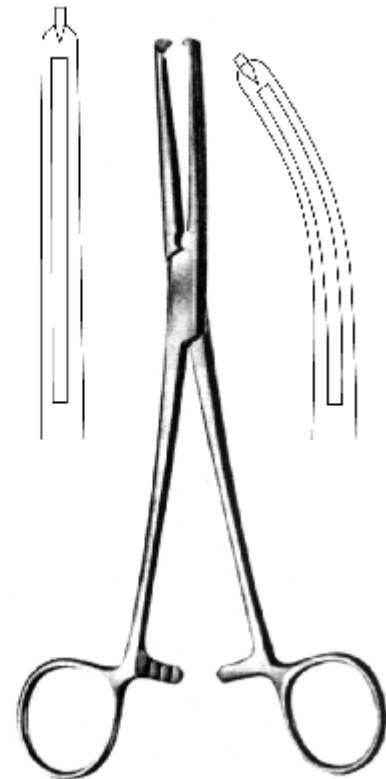

MAINGOT
14.0536.20 20.0cm 14.0537.20

ARTERY FORCEPS

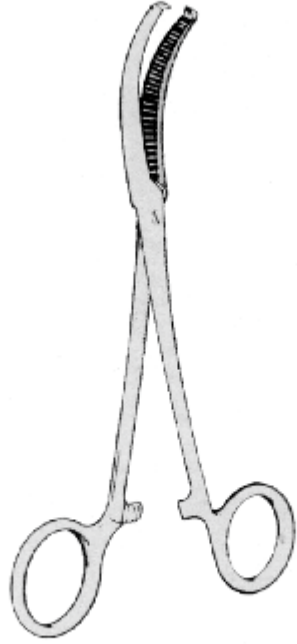

BERKELEY
14.0540.20 20.0 cm



BERKELEY BONNEY
14.0544.19 19.0 cm

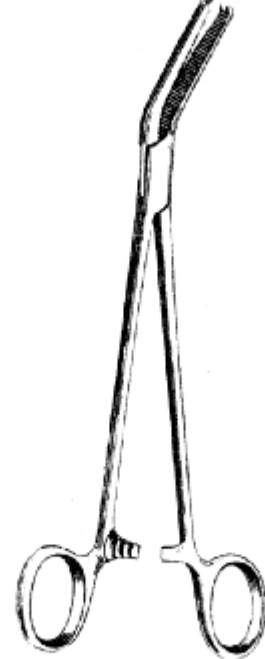

BONNEY
14.0548.20 20.5 cm

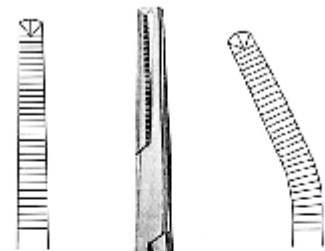

14.0550.21

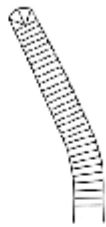

14.0551.21



14.0556.23
23.0 cm

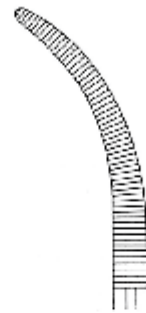

14.0556.24
24.0 cm



PHANEUF
21.0cm

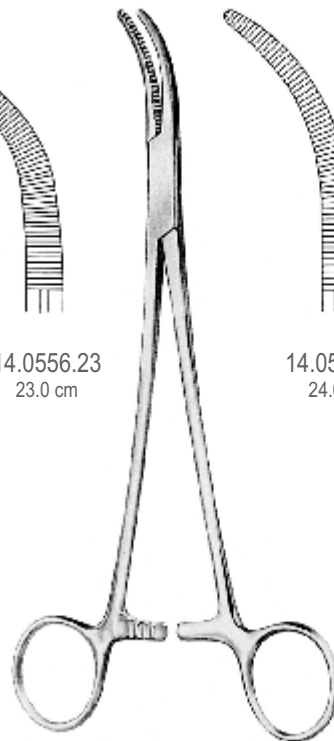

MOYNIHAN

Clamps-Forceps, Hysterectomy and Vaginal Forceps
 Klemmzangen, Hysterektomieklemmen, Vaginalklemmen
 Pinzas-clamps, pinzas-clamps para histerectoia y vaginales
 Зажимы влагалищные
 夹具, 钳, 子宫和阴道钳

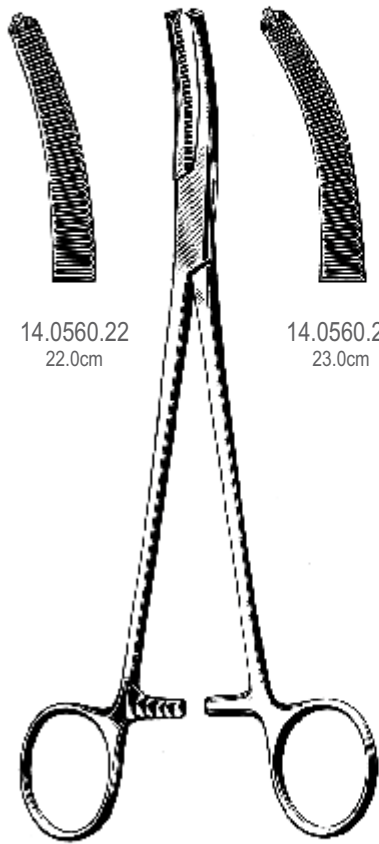

14.0560.22
22.0cm

WERTHEIM



14.0560.23
23.0cm

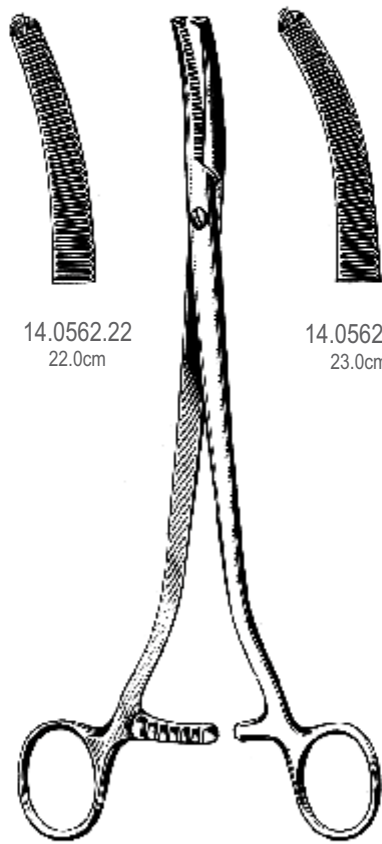

14.0562.22
22.0cm

WERTHEIM



14.0562.23
23.0cm



14.0566.24
24.0cm

WERTHEIM

ARTERY FORCEPS

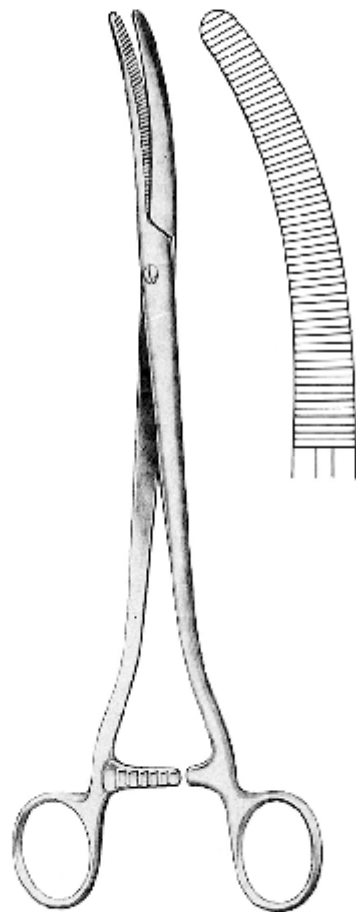

FAURE
14.0570.25 25.0cm

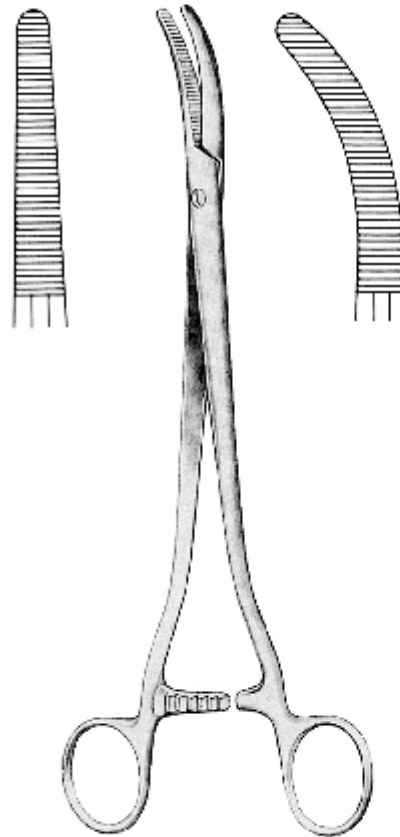

SEGOND-LANDAU
14.0576.24 24.0cm 14.0577.24

Clamps-Forceps, Hysterectomy and Vaginal Forceps
Klemmzangen, Hysterektomieklemmen, Vaginalklemmen
Pinzas-clamps, pinzas-clamps para histerectoia y vaginales
Зажимы влагалищные
夹具, 钳, 子宫和阴道钳

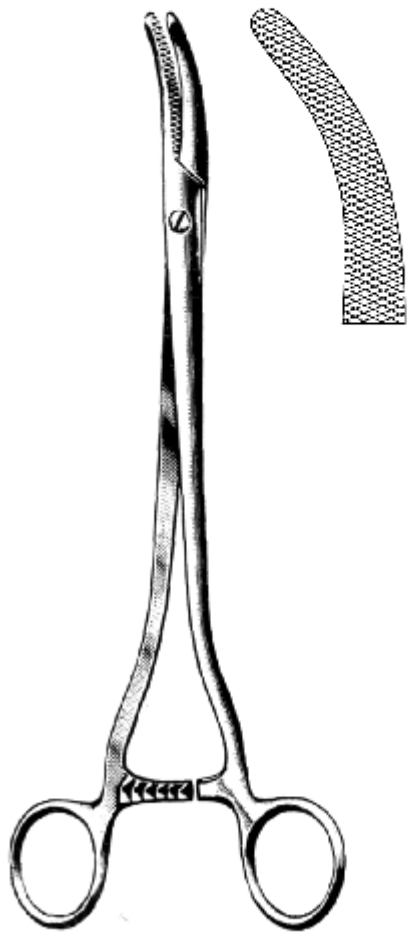

WERTHEIM
14.0580.25 25.0cm

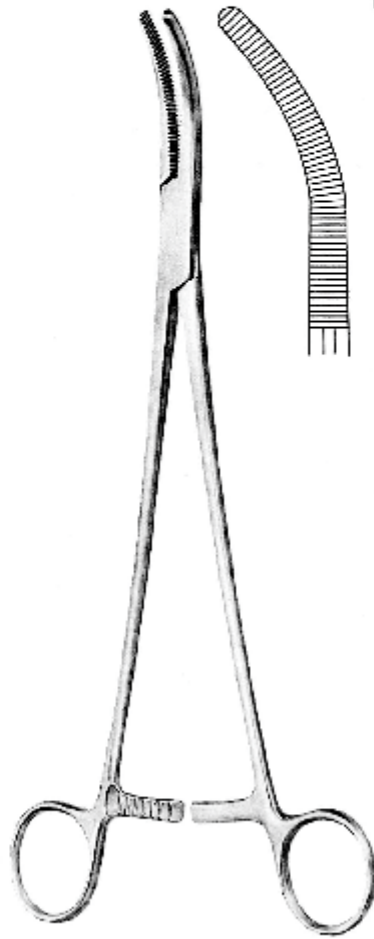

WERTHEIM
14.0582.25 25.0cm

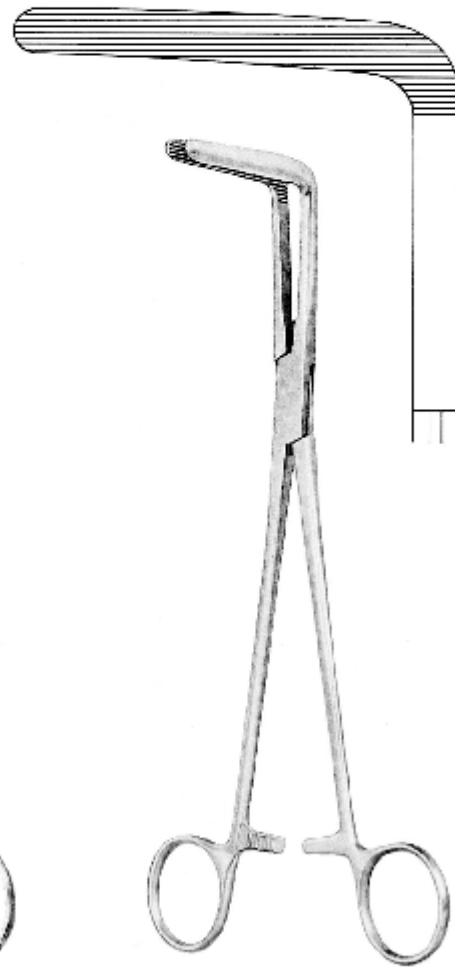

WERTHEIM-CULLEN
14.0586.21 21.5cm

ARTERY FORCEPS

ATRAUMA

ARTERY FORCEPS

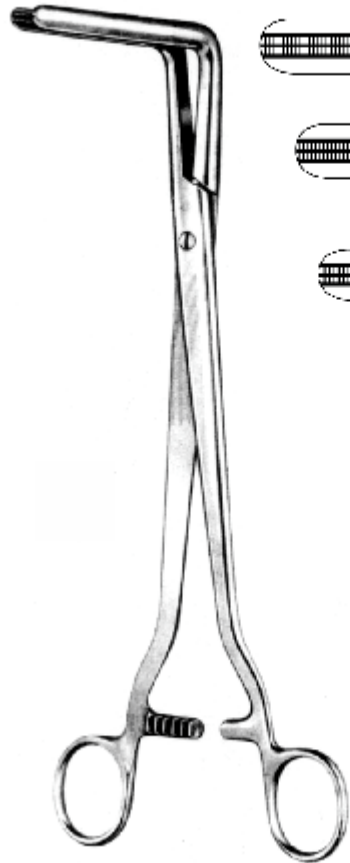

WERTHEIM
24.0cm

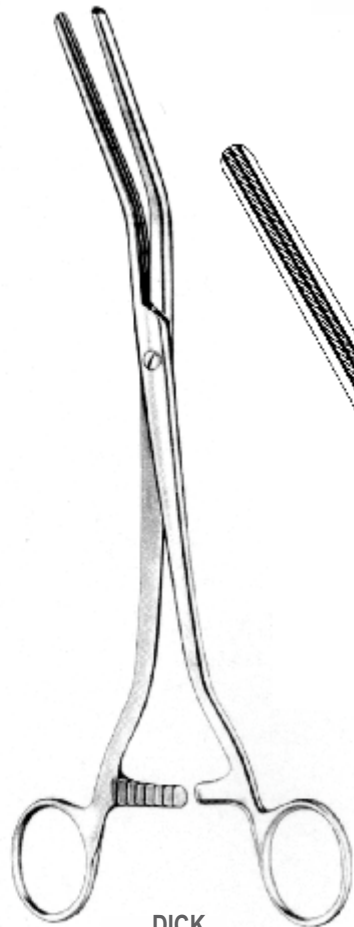
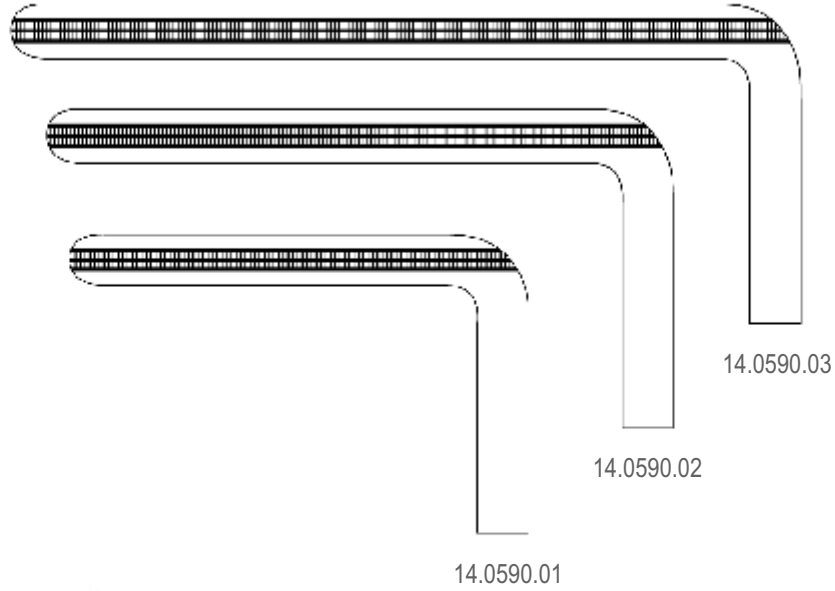

DICK

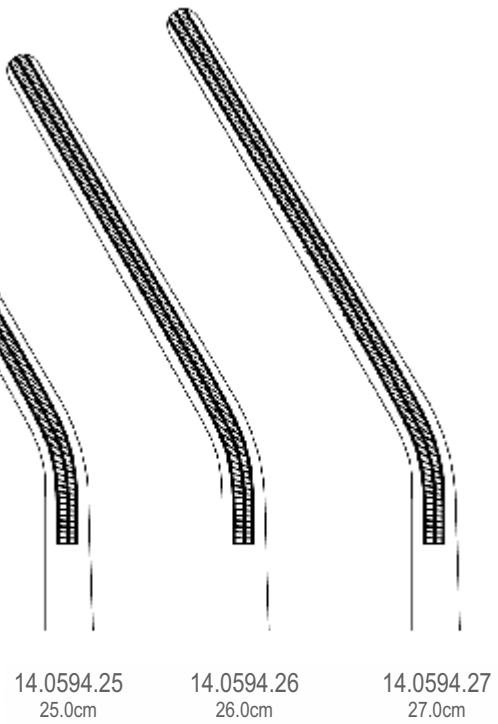

Hysterectomy Forceps
Hysterektomieklemmen
Pinzas-clamps para hysterectomia
Зажимы для гистерэктомии
子宫切除术钳



ATRAUMA



ROGERS

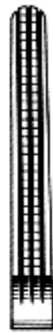

14.0600.01
22.0cm



14.0600.02
21.5cm



14.0600.03
21.0cm

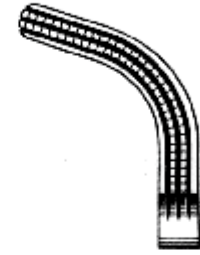

14.0600.04
20.5cm



14.0602.01
25.0cm



14.0602.02
25.0cm

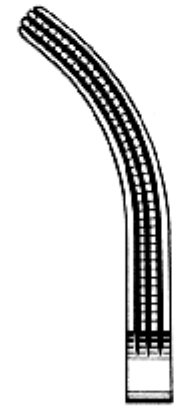

14.0602.03
24.5cm

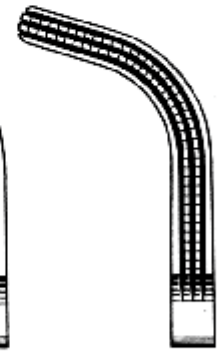

14.0602.04
23.0cm

ARTERY FORCEPS

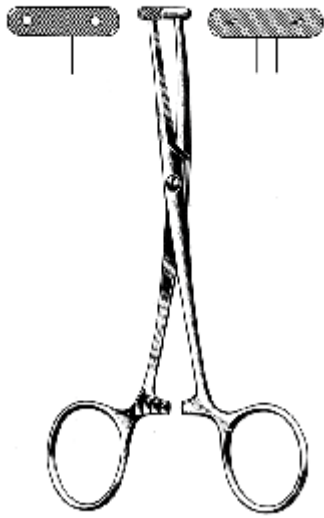

MARTEL
14.0620.14 14.0cm

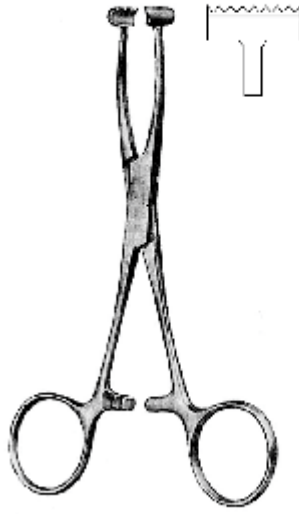

PRATT
14.0624.15 15.0cm

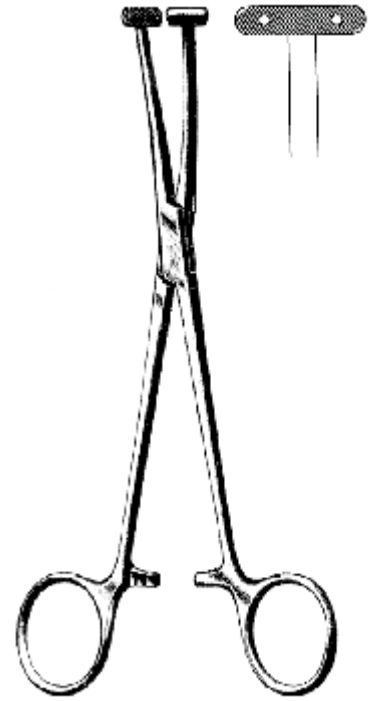

WILLET-MARTEL
14.0628.19 19.0cm

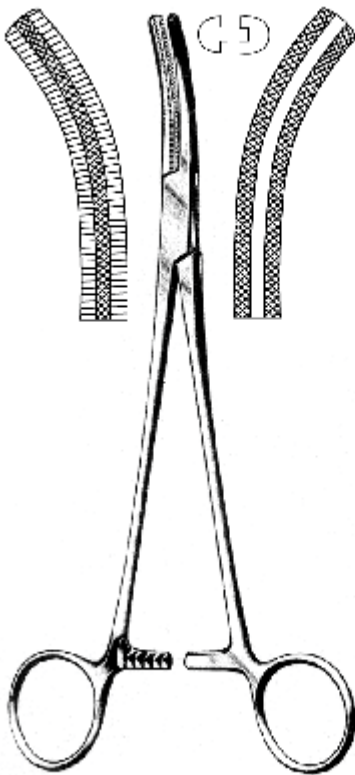

BUIE
14.0630.21 21.0cm

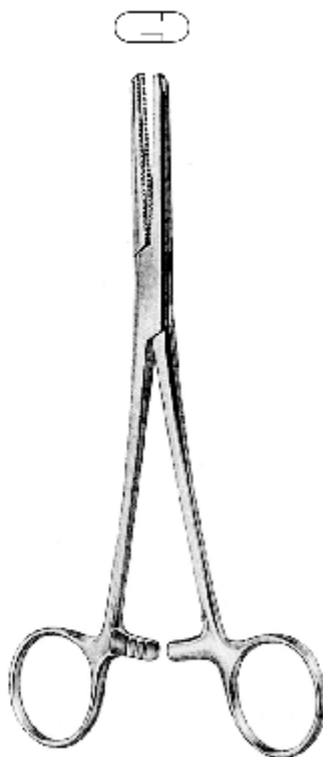

FERGUSSON

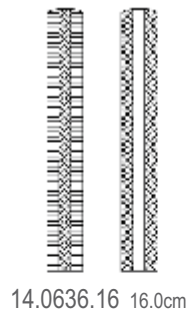

14.0636.16 16.0cm

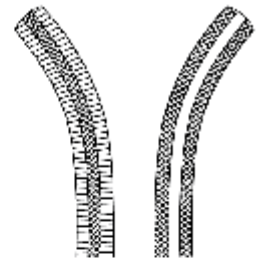

14.0637.16 16.0cm

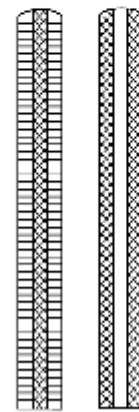

14.0636.20 20.0cm

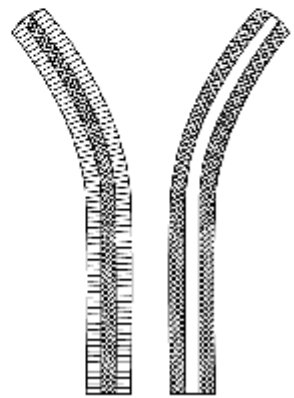

14.0637.20 20.0cm

Artery Forcep, Tumor Seizing Forceps
 Arterienklemmen, Tumorfassklemmen
 Pinzas hemostaticas, pinzas para sacar tumores
 Щипцы для захвата опухоли
 组织夹持钳

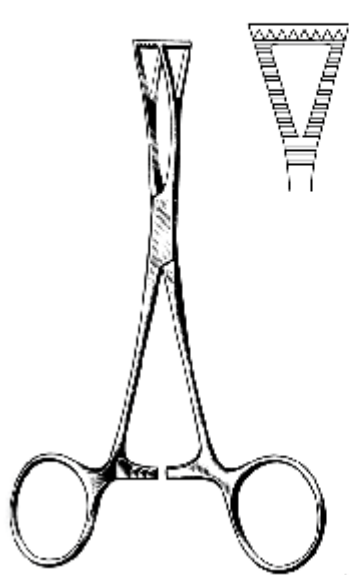

COLLIN
 14.0640.14 14.0cm

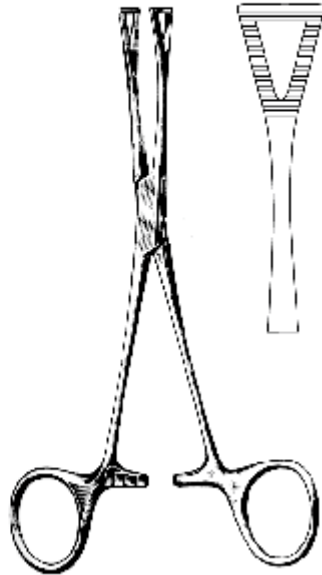

PENNINGTON
 14.0646.15 15.5cm
 14.0646.20 20.0cm

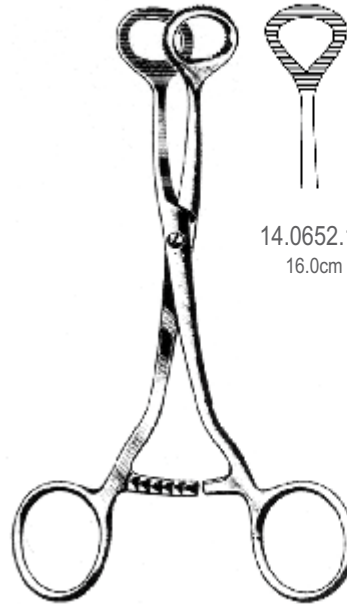

COLLIN
 14.0650.16 16.0cm



14.0652.16
 16.0cm



14.0654.16
 16.0cm



14.0656.16
 16.0cm

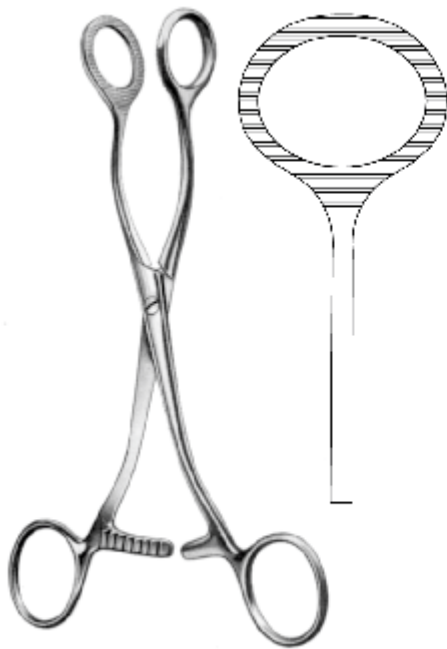

COLLIN
 14.0658.16 16.5cm

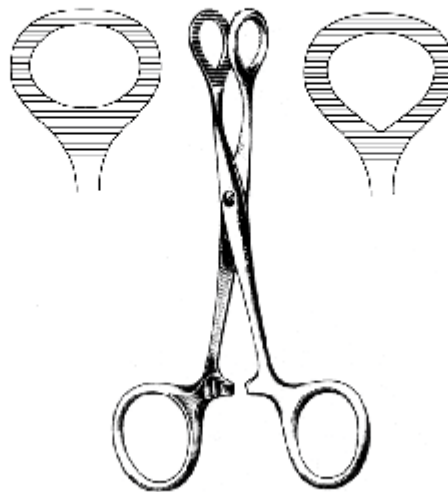

PEAN
 14.0660.12 12.0cm 14.0662.12



HOPFNER
 14.0666.16 16.0cm

ARTERY FORCEPS

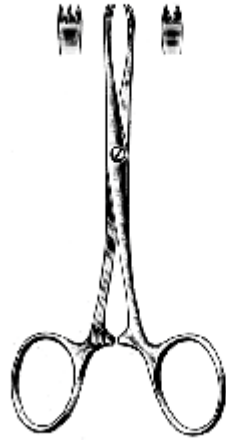

CHAPUT
14.0670.13 13.0cm

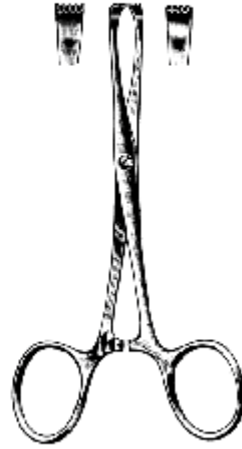

TUFFIER
14.0674.13 13.0cm

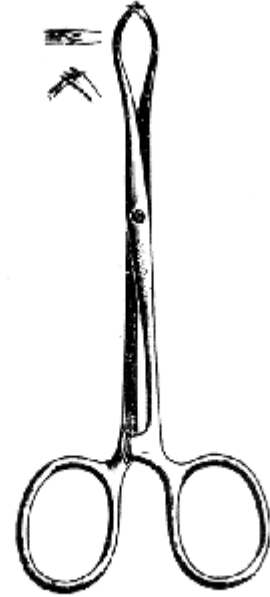

PORRIER
14.0678.12 12.5cm
14.0678.18 18.0cm



LANE
14.0680.12 12.5cm
14.0680.15 15.0cm
14.0680.19 19.5cm

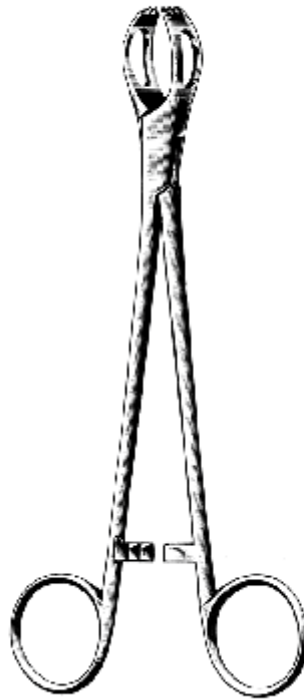

LANE
14.0682.12 12.5cm
14.0682.15 15.0cm
14.0682.20 20.0cm



ATRAUMA



14.0686.25 25.0cm



14.0688.26 26.0cm

Tubing Clamp
 Schlauchklemmen
 Pinzas para tubos
 Зажимы для трубок
 管夹

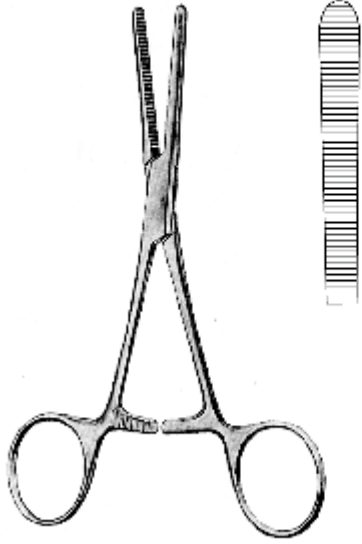

14.0690.14 14.5cm

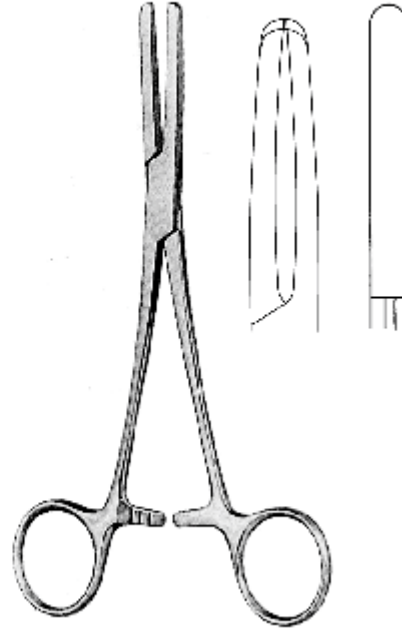

14.0692.16 16.5cm
 14.0692.18 18.0cm
 14.0692.20 20.0cm

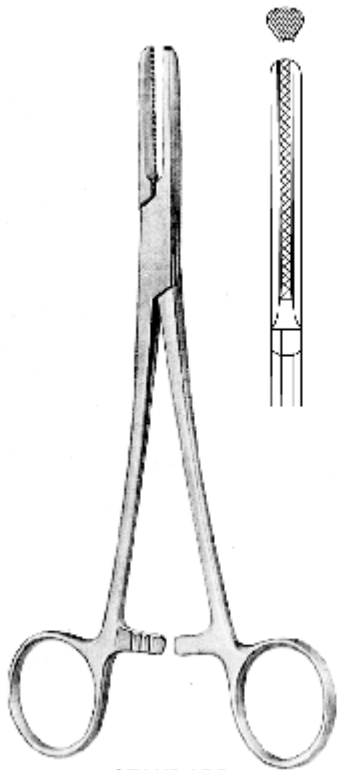

STANDARD
 14.0700.15 15.0cm
 14.0700.18 18.0cm
 14.0700.20 20.0cm

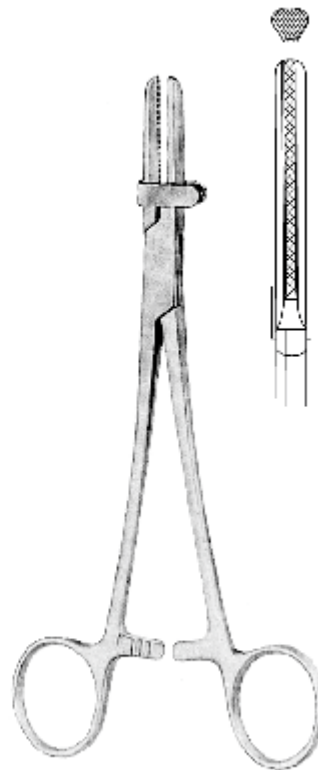

14.0702.15 15.0cm
 14.0702.16 16.5cm
 14.0702.18 18.0cm
 14.0702.20 20.0cm

ARTERY FORCEPS

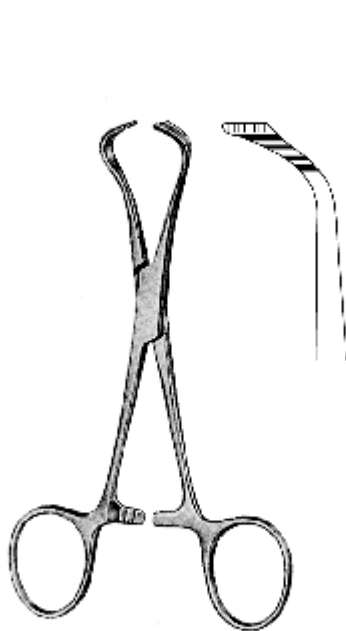

LORNA
14.0710.10 10.0cm
14.0710.13 13.0cm

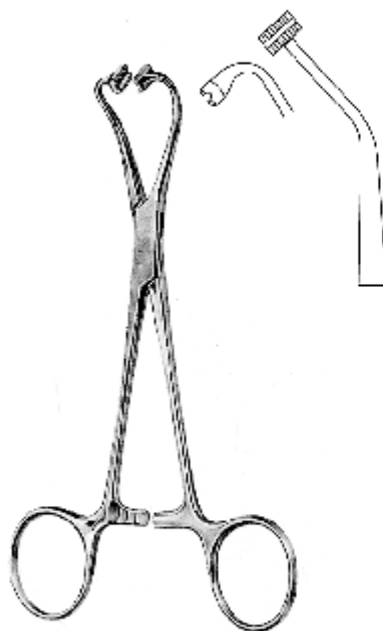

PEERS-BERTRAM
14.0714.14 14.5cm

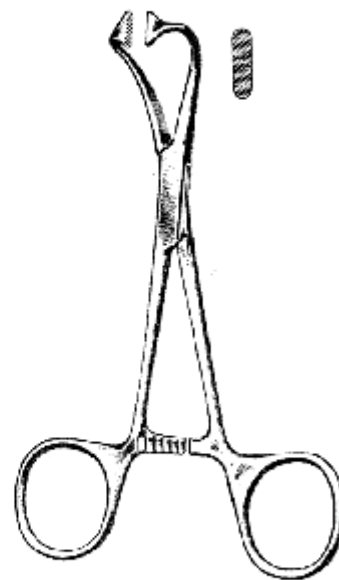

14.0718.10 10.0cm
14.0718.13 13.0cm

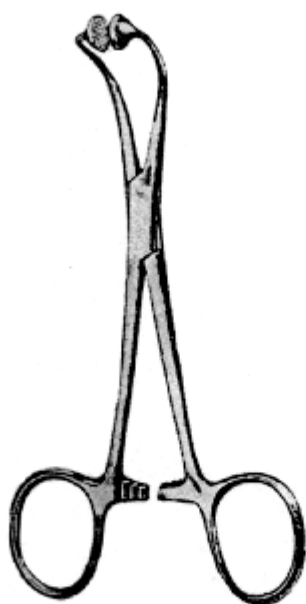

HOFF (HOFER)
14.0720.10 10.0cm
14.0720.14 14.5cm



BALL AND SOCKET
14.0722.13 13.0cm



TOHOKU
14.0726.10 10.0cm
14.0726.13 13.0cm

Towel Clamps
 Tuchklemmen
 Pinzas para compresas, pinzas de campo
 Зажимы для операционного белья
 毛巾夹



SCHAEDEL
 14.0730.09 9.0cm



ENGLISH MODEL
 14.0732.09 9.0cm



JONES
 14.0734.05 5.0cm
 14.0734.09 9.0cm



JONES
 14.0736.09 9.0cm

ARTERY FORCEPS

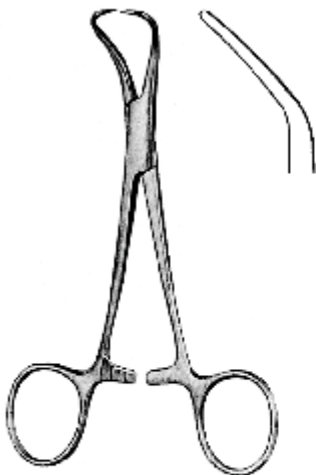

BACKHAUS
 14.0740.08 08.0cm
 14.0740.09 09.0cm
 14.0740.11 11.0cm
 14.0740.13 13.0cm
 14.0740.14 14.0cm
 14.0740.15 15.0cm



DELICATE
 14.0742.11 11.0cm
 14.0742.13 13.0cm



14.0746.11 11.0cm



ROEDER
 14.0750.13 13.0cm
 14.0750.15 15.0cm



ROBIN
14.0754.13 13.5cm



ROBIN
14.0756.13 13.5cm



BERNHARD
14.0758.16 16.5cm

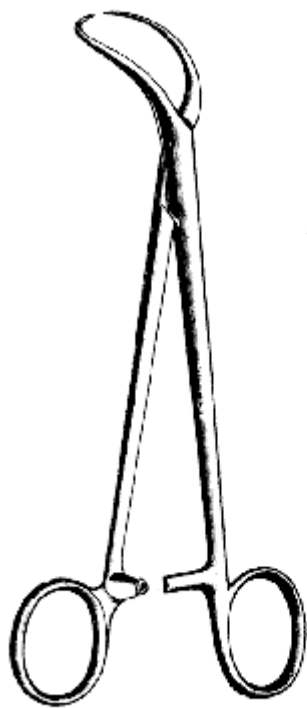

MAYO
14.0760.14 14.0cm

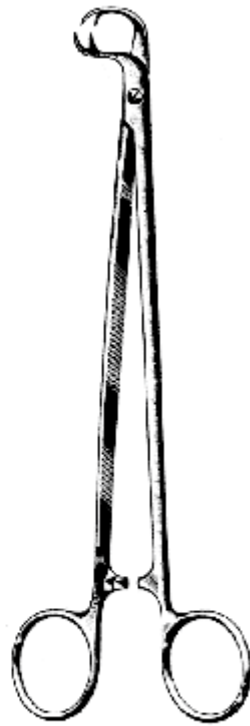

MOYNIHAN
14.0762.19 19.0cm



MOYNIHAN
14.0764.18 18.0cm



DOYEN
14.0766.18 18.0cm



SURGICAL
INSTRUMENTS



THE ULTIMATE CHOICE

Hilton
PREMIUM STAINLESS STEEL



THE ULTIMATE CHOICE

**COTTON SWAB
FORCEPS**

Cotton Swab Forceps

Tupferzangen

Pinzas para taphones

ЩИПЦЫ ДЛЯ ПЕРЕВЯЗОЧНОГО МАТЕРИАЛА И ТАМПОНОВ

棉签钳

16

001 - 006

Dressing and Cotton Swab Forceps
Kornzangen und Tupferzangen
Pinzas para vendajes y tapones
Щипцы для перевязочного материала и тампонов
敷料和棉签钳

Hilton
PREMIUM STAINLESS STEEL

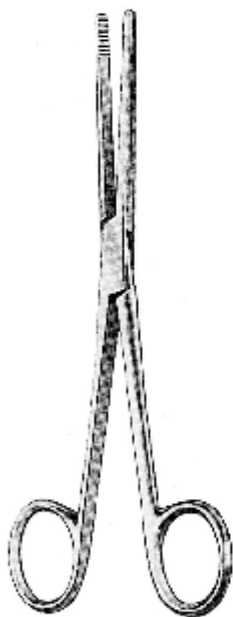

LISTER

16.0010.12 12.5cm
16.0010.15 15.0cm
16.0010.18 18.0cm
16.0010.20 20.0cm

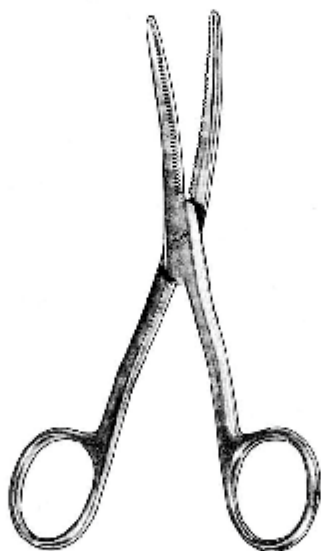

BRYANT

16.0014.12 12.5cm

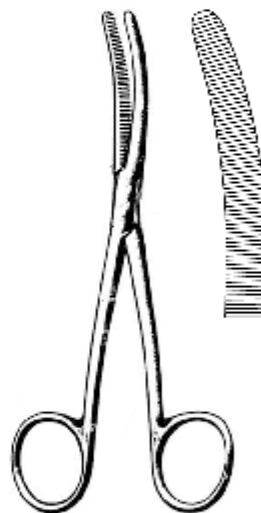

BRYANT

16.0016.12 12.5cm

COTTON SWAB FORCEPS

COTTON SWAB FORCEPS

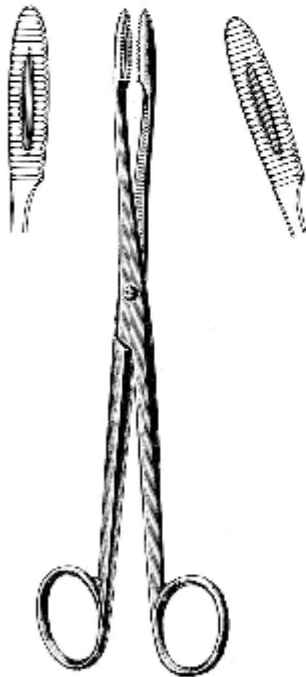

GROSS-MAIER
16.0020.16 16.0cm 16.0021.16
16.0020.18 18.0cm 16.0021.18
16.0020.20 20.0cm 16.0021.20
16.0020.25 25.0cm 16.0021.25

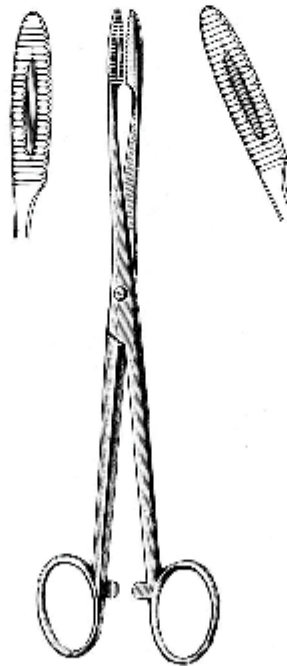

GROSS-MAIER
16.0024.16 16.0cm 16.0025.16
16.0024.18 18.0cm 16.0025.18
16.0024.20 20.0cm 16.0025.20
16.0024.25 25.0cm 16.0025.25

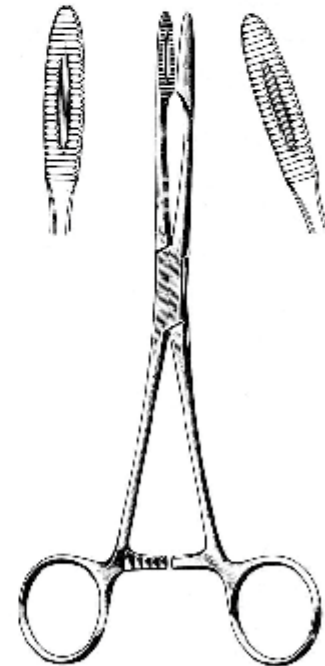

GROSS-MAIER
16.0030.18 18.0cm 16.0031.18
16.0030.20 20.0cm 16.0031.20
16.0030.22 22.0cm 16.0031.22
16.0030.25 25.0cm 16.0031.25
16.0030.27 27.0cm 16.0031.27

Dressing and Cotton Swab Forceps
 Kornzangen und Tupferzangen
 Pinzas para vendajes y tapones
 Щипцы для перевязочного материала и тампонов
 敷料和棉签钳

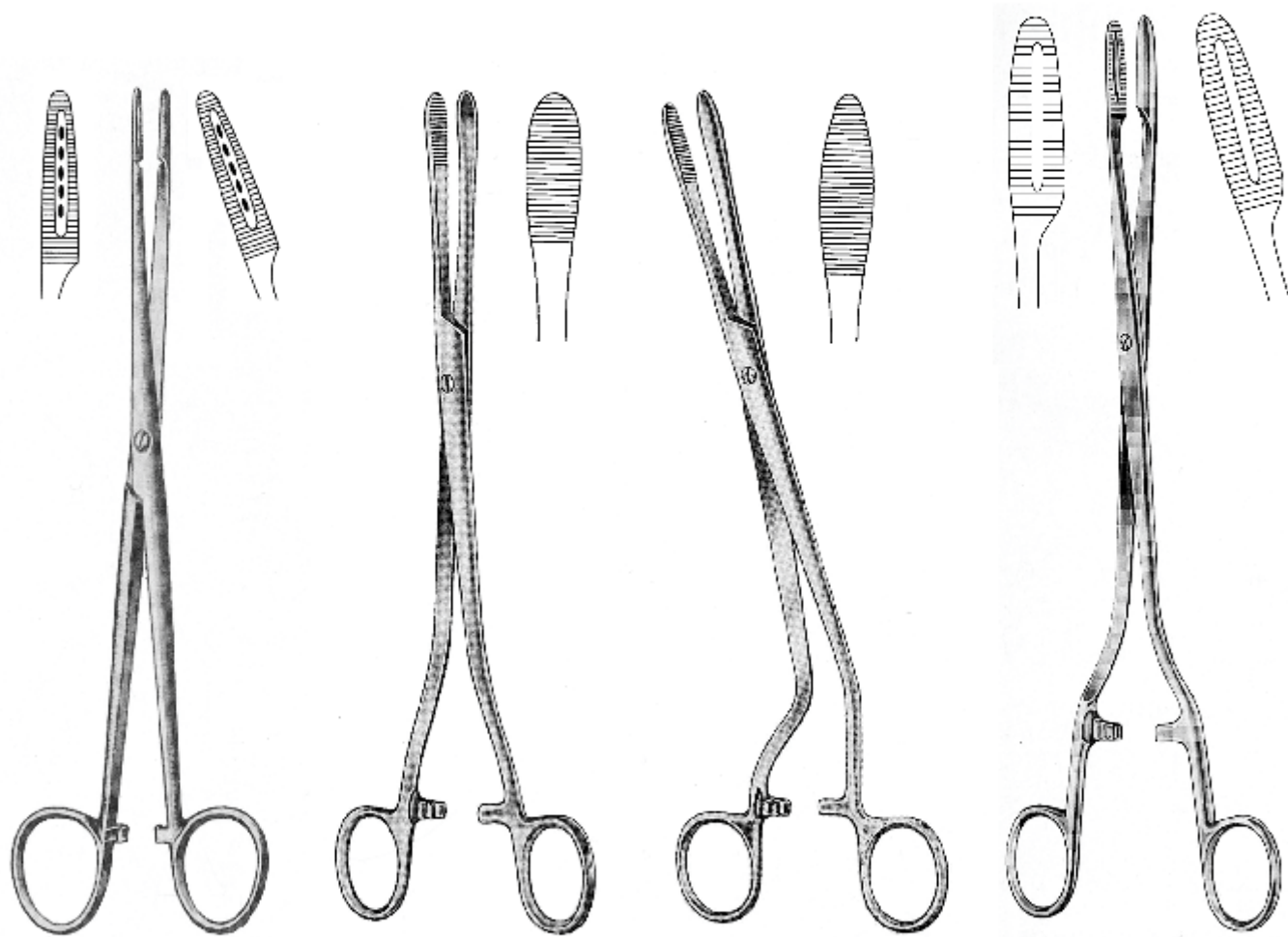

COTTON SWAB FORCEPS

MAIER
 16.0034.25 25.0cm 16.0035.25

COLLIN
 16.0040.25 25.0cm

CHERON
 16.0044.25 25.0cm

SIMS-MAIER
 16.0048.28 28.0cm 16.0049.28

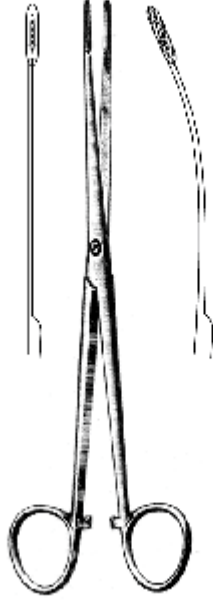

16.0050.17 17.0cm
16.0051.17 17.0cm

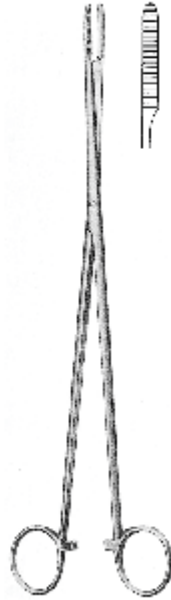

PELKMANN
16.0054.25 25.0cm
16.0055.25 25.0cm

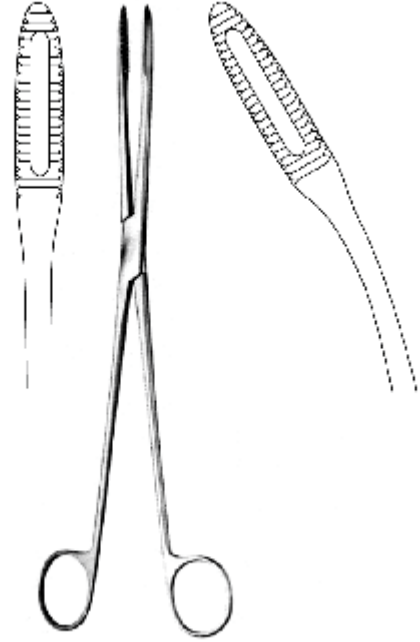

MAIER
16.0056.20 20.0cm 16.0057.20
16.0056.26 26.0cm 16.0057.26

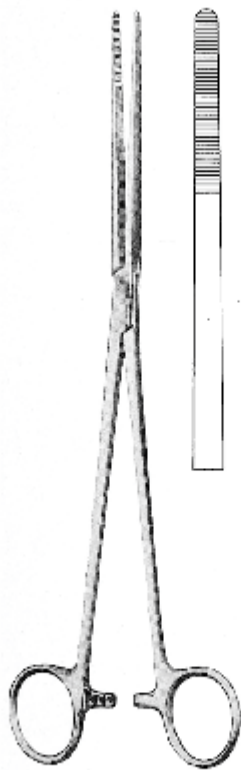

BOZEMANN
16.0060.26 26.0cm

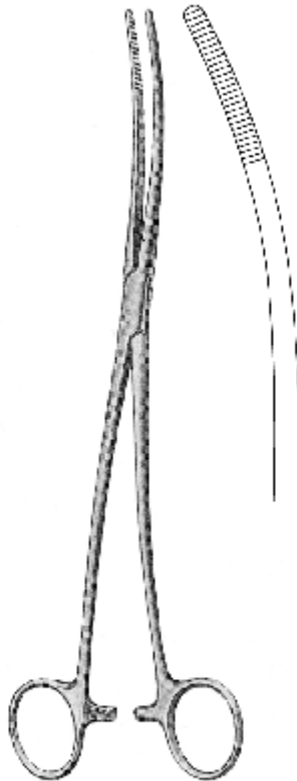

BOZEMANN
16.0062.26 26.0cm

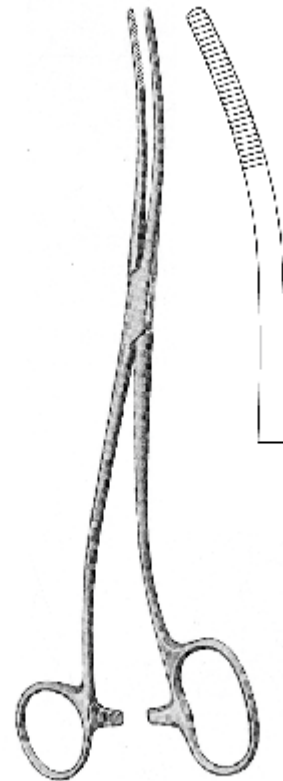

BOZEMANN-DOUGLAS
16.0064.26 26.0cm

Dressing and Cotton Swab Forceps
 Kornzangen und Tupferzangen
 Pinzas para vendajes y tapones
 Щипцы для перевязочного материала и тампонов
 敷料和棉签钳

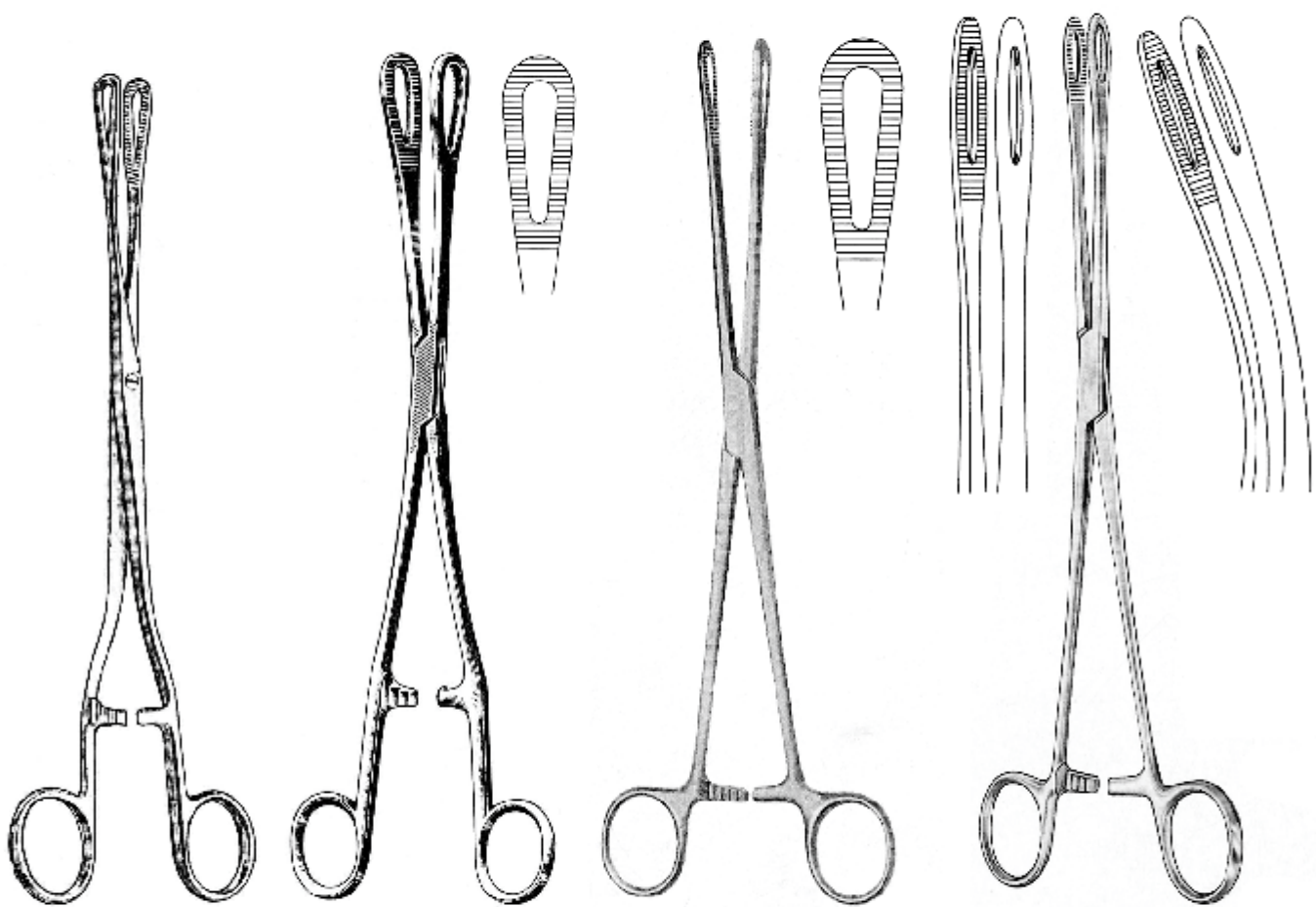

COTTON SWAB FORCEPS

RAMPLEY
 16.0070.18 18.0cm
 16.0070.25 25.0cm

RAMPLEY
 16.0072.18 18.0cm
 16.0072.25 25.0cm

RAMPLEY
 16.0074.18 18.0cm
 16.0074.25 25.0cm

FOERSTER
 16.0076.25 25.0cm
 16.0077.25 25.0cm

COTTON SWAB FORCEPS

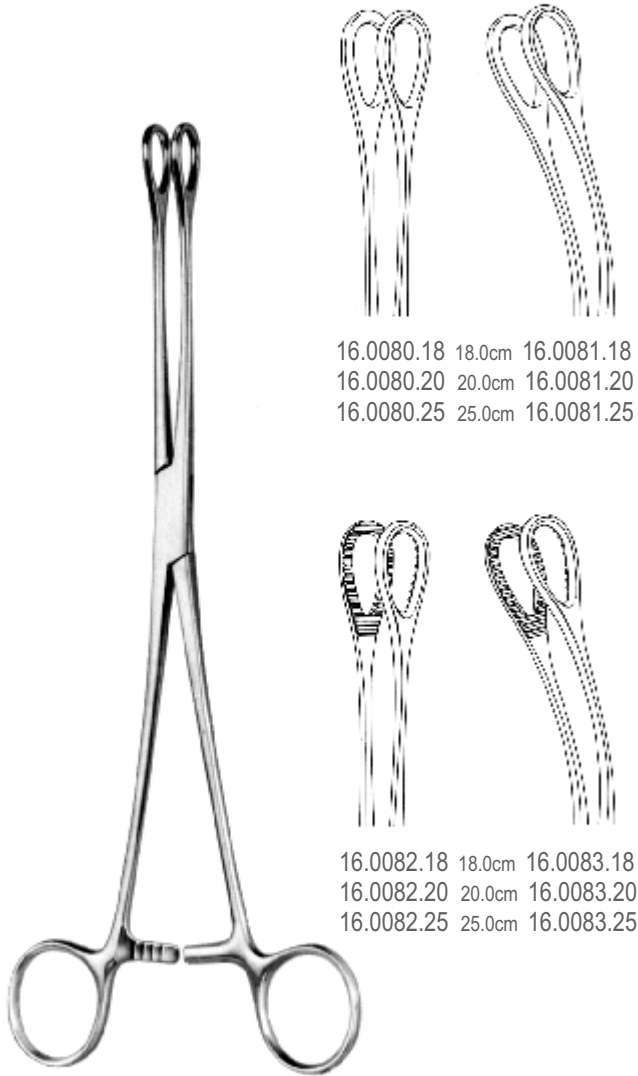

FOERSTER

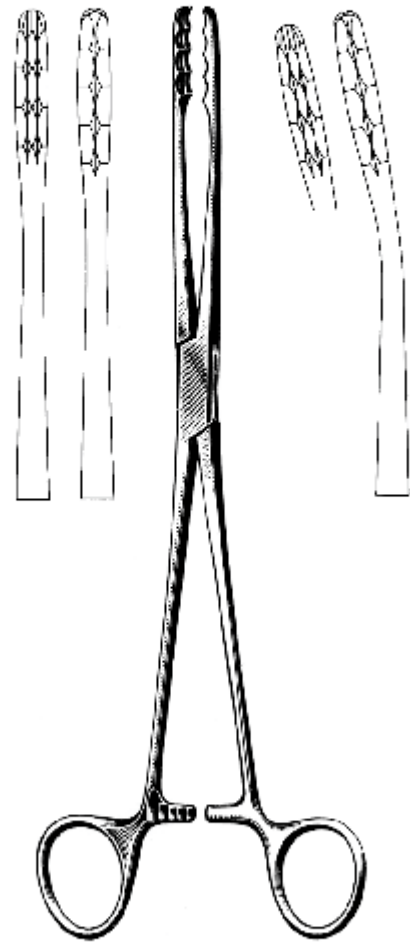

ULRICH



SURGICAL
INSTRUMENTS



THE ULTIMATE CHOICE

Hilton
PREMIUM STAINLESS STEEL



THE ULTIMATE CHOICE

RETRACTORS

Retractors
Wundhaken
Separadores
РЕТРАКТОРЫ
拉钩

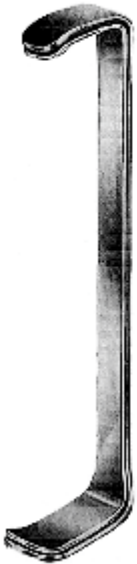

Fig.1=26x10mm
Fig.2=30x10mm

Fig.1=30x13mm
Fig.2=34x13mm

FARABEU
12.0cm
18.0010.00 Set
18.0010.01 Fig.1
18.0010.02 Fig.2



Fig.1=23x16mm
Fig.2=27x16mm

Fig.1=26x16mm
Fig.2=30x16mm

FARABEU
15.0cm
18.0012.00 Set
18.0012.01 Fig.1
18.0012.02 Fig.2



Fig.1=28x18mm
Fig.2=32x18mm

Fig.1=29x20mm
Fig.2=33x20mm

MAYO-COLLIN
15.0cm
18.0014.00 Set
18.0014.01 Fig.1
18.0014.02 Fig.2



Fig.1=21x24mm
Fig.2=25x24mm

Fig.1=40x15mm
Fig.2=45x15mm

U.S.ARM
21.0cm
18.0018.00 Set
18.0018.01 Fig.1
18.0018.02 Fig.2



Fig.1=42x13mm
Fig.2=47x13mm

Fig.1=42x26mm
Fig.2=46x26mm

MATHIEU
20.0cm
18.0022.00 Set
18.0022.01 Fig.1
18.0022.02 Fig.2

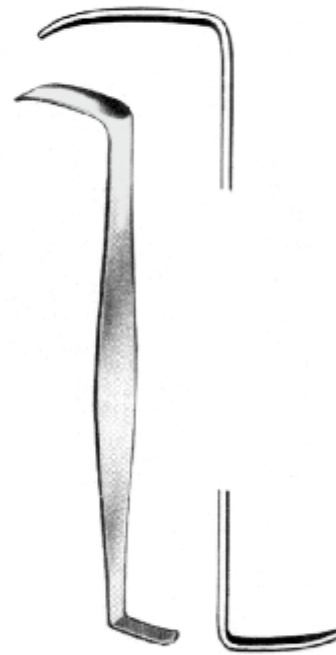

CRILE
11.0cm
18.0026.11



Fig.1=19x15mm
Fig.2=22x15mm

Fig.1=19x15mm
Fig.2=22x15mm

PARKER
13.5cm
18.0030.00 set
18.0030.01 Fig.1
18.0030.02 Fig.2



Fig.1=26x25mm
Fig.2=29x25mm

Fig.1=24x25mm
Fig.2=27x25mm

PARKER
18.0cm
18.0034.00 set
18.0034.01 Fig.1
18.0034.02 Fig.2



Fig.1=21x24mm
Fig.2=25x24mm

Fig.1=68x24mm
Fig.2=72x24mm

PARKER-MOTT
16.0cm
18.0038.00 set
18.0038.01 Fig.1
18.0038.02 Fig.2



MINI-ROUX
18.0042.14
14.0cm



BABY-ROUX
18.0046.13
13.0cm

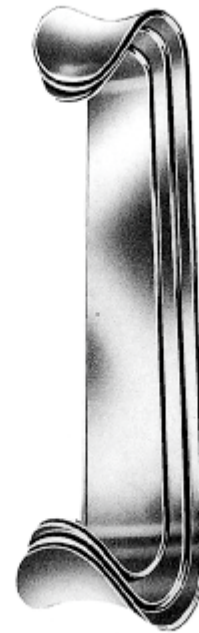
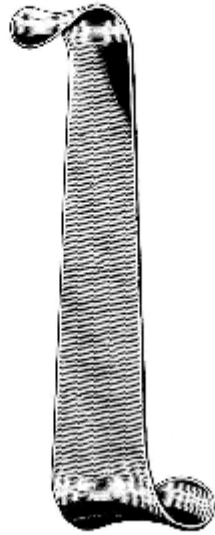

Fig.1=24x20mm
Fig.2=29x26mm
Fig.3=33x29mm
Fig.4=29x24mm

Fig.1=30x28mm
Fig.2=36x36mm
Fig.3=38x43mm
Fig.4=45x28mm

ROUX
18.0050.00 set 1-3
18.0050.01 Fig.1 14.0cm
18.0050.02 Fig.2 15.0cm
18.0050.03 Fig.3 17.0cm
18.0050.04 Fig.4 18.0cm



ROUX-MAGNUS
18.0054.00 set
18.0054.14 14.0cm
18.0054.15 15.0cm
18.0054.17 17.0cm

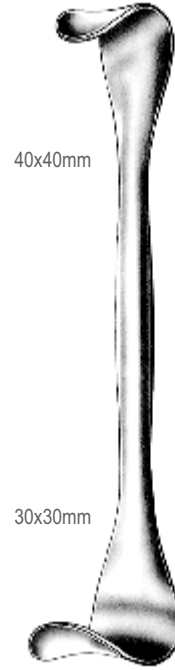

40x40mm

30x30mm

GOELET
18.0058.19 19.0cm

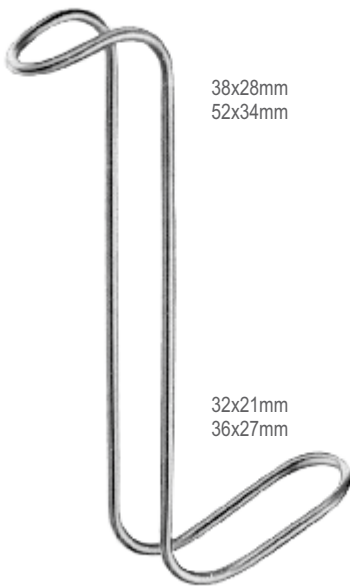

38x28mm
52x34mm

32x21mm
36x27mm

COLLIN-HARTMANN
18.0060.14 14.0cm
18.0060.16 16.0cm



CANNY-RYALL
18.0066.16 16mm, 19.0cm
18.0066.20 20mm, 19.0cm
18.0066.25 25mm, 20.0cm

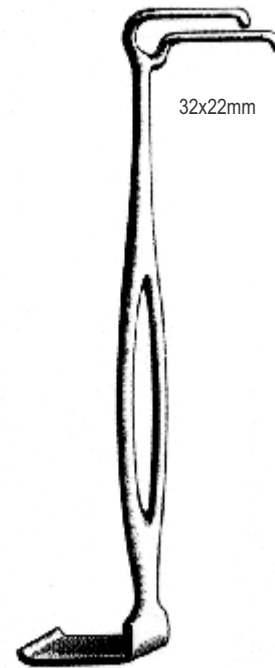

32x22mm

CZERNY
18.0070.20 20.0cm

RETRACTORS

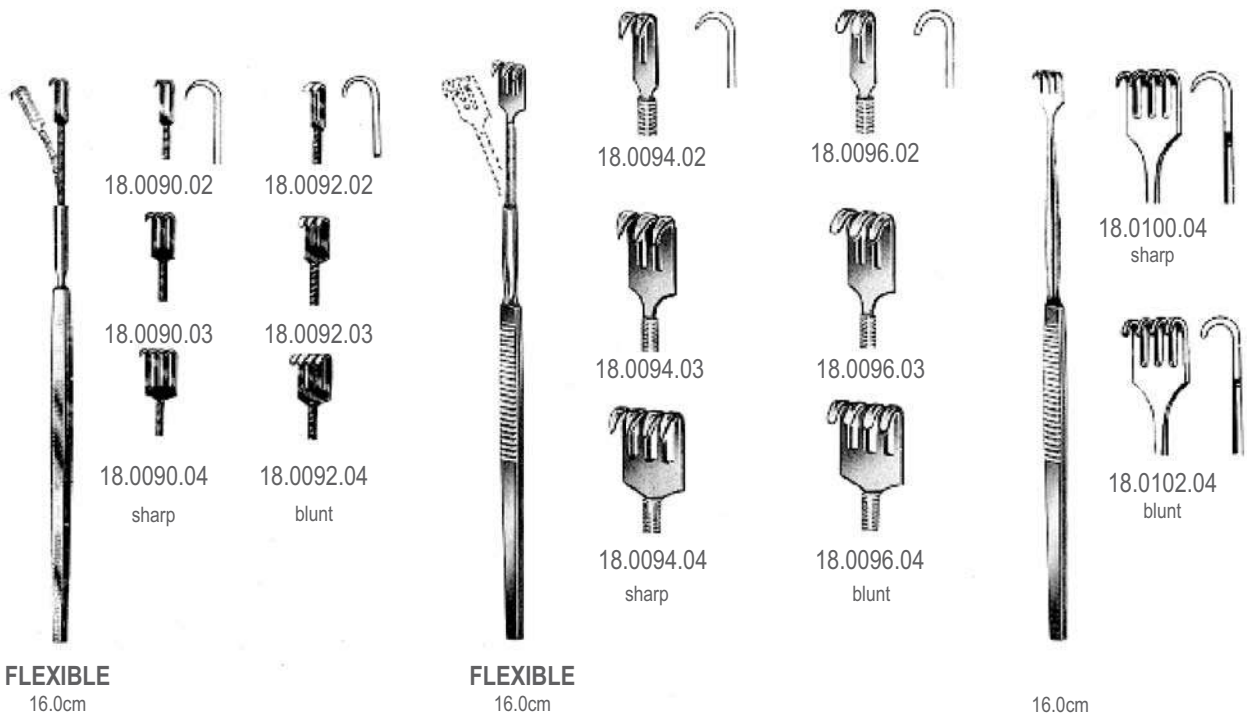
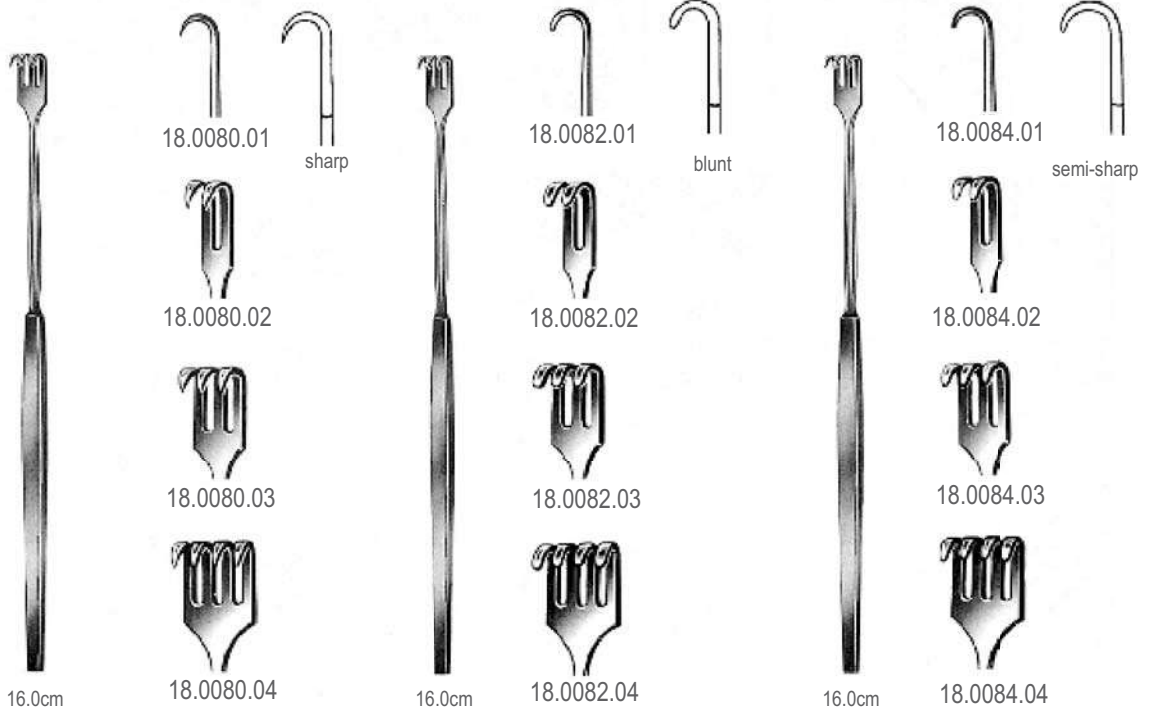

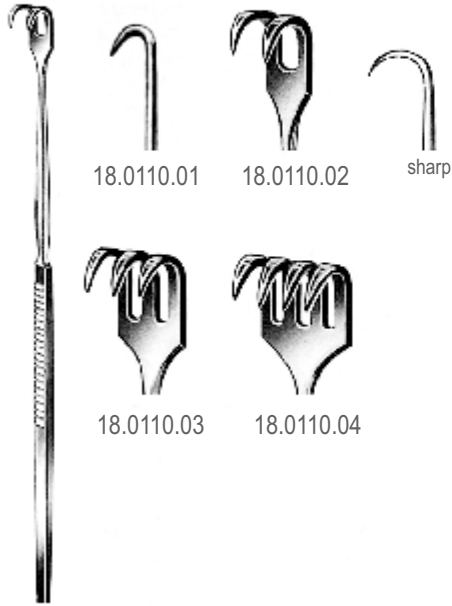

16.0cm

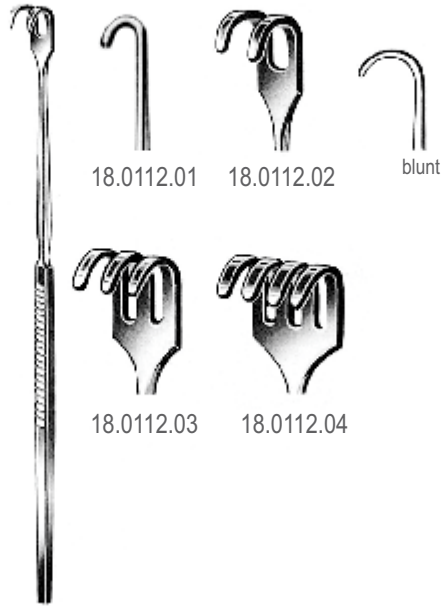

16.0cm

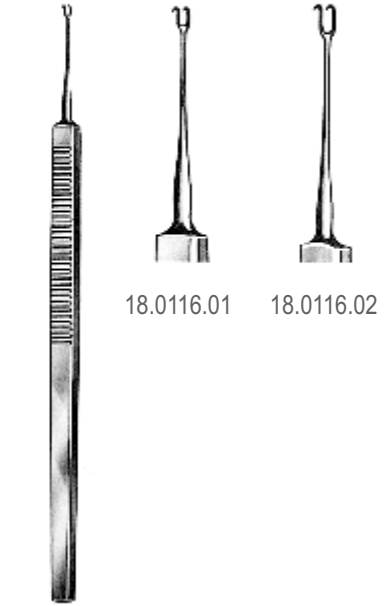

GUTHRIE
16.0cm

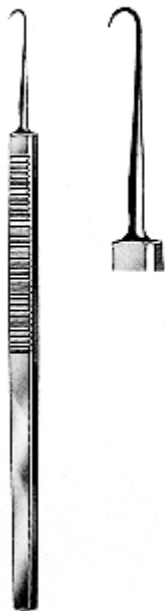

O'CONNOR
18.0120.16 16.0cm

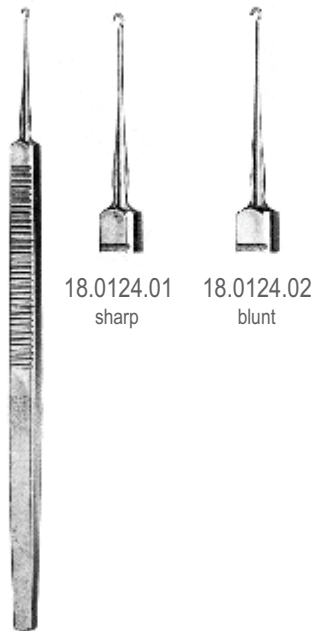

GRAEFE
16.0cm

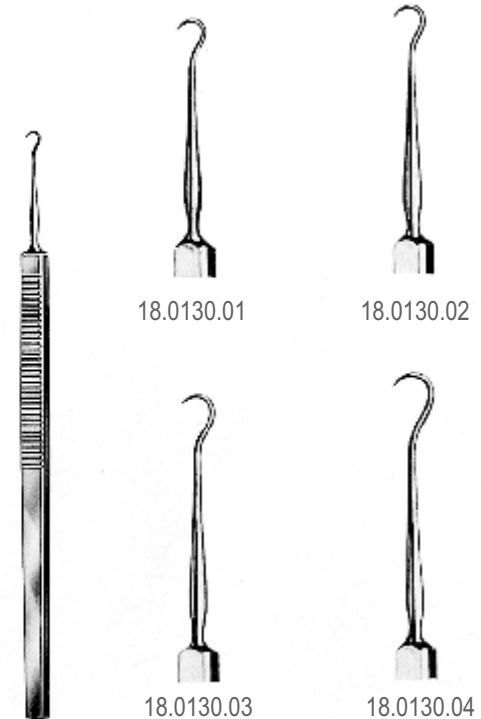

16.0cm

RETRACTORS

RETRACTORS

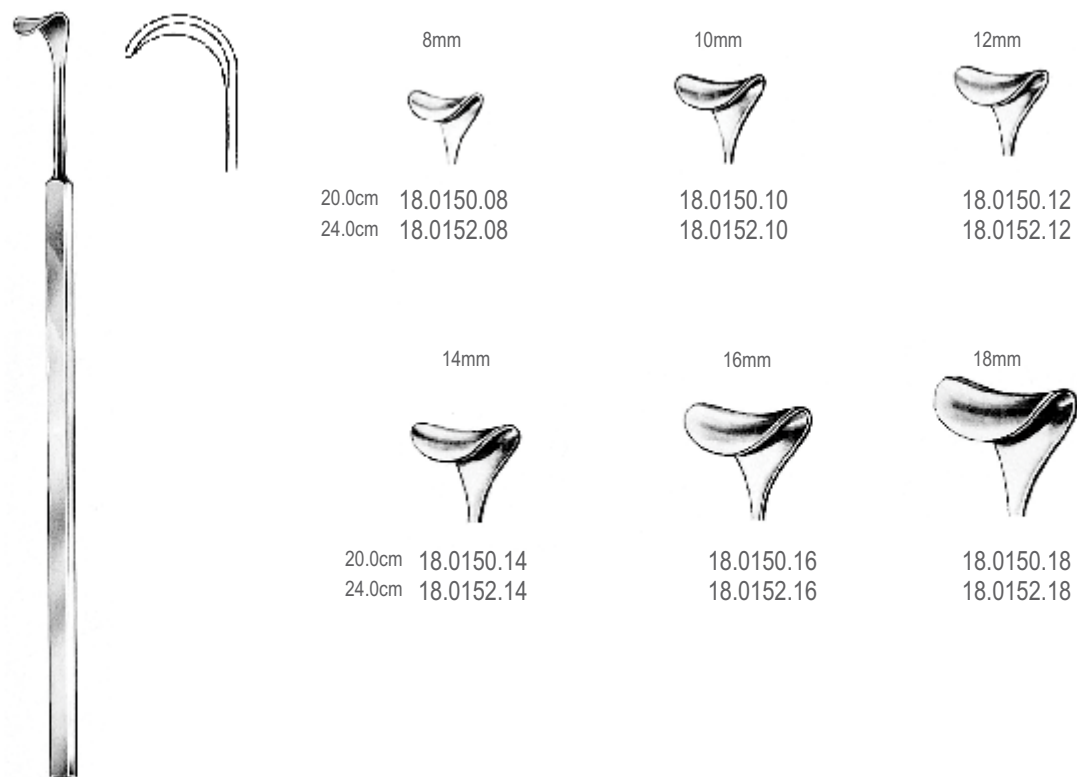
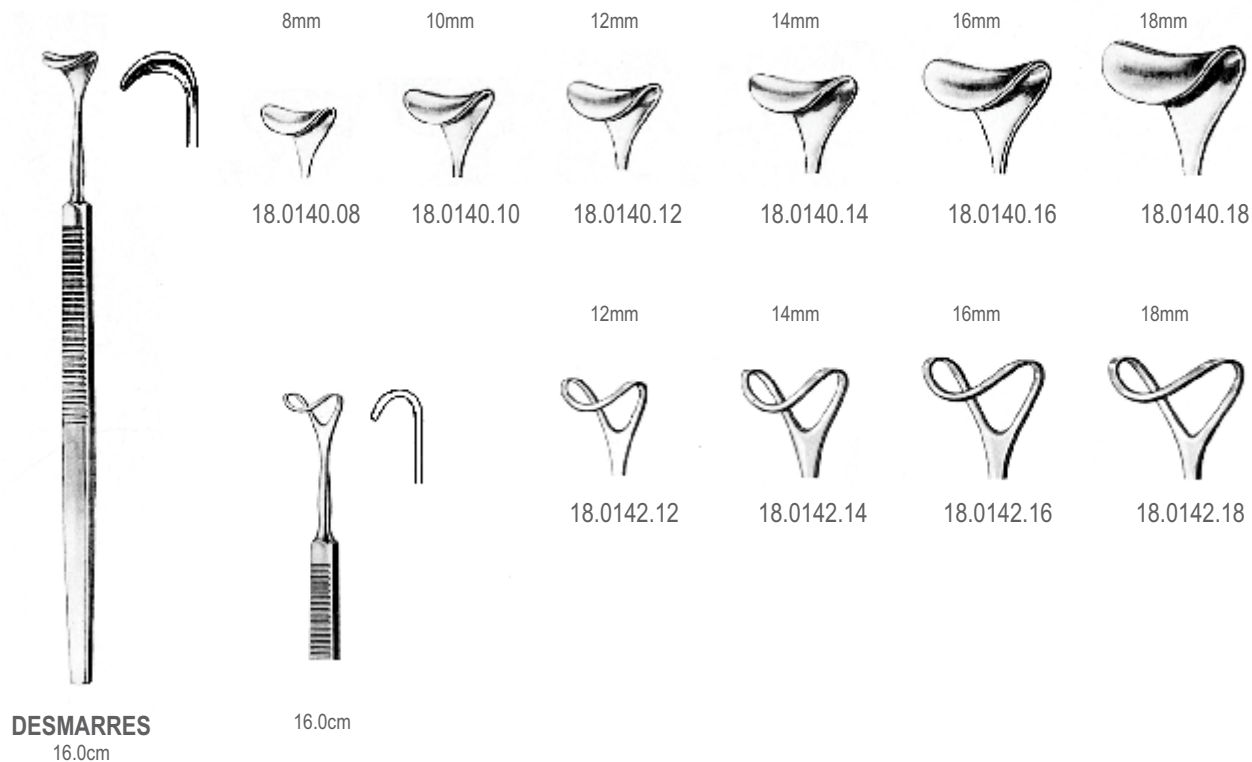

Retractors
 Wundhaken
 Separadores
 Ретракторы хирургические
 拉钩

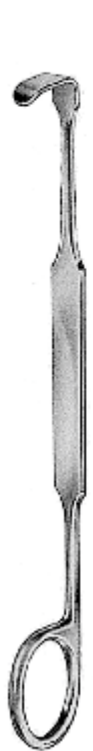

MEYERDING
 18.0cm



18.0156.01
 18x7mm



18.0156.02
 16x5mm



18.0156.03
 7x4mm



18.0156.04
 10x3mm



18.0156.05
 7x4mm



18.0156.06
 10x4mm



SENN-GREEN
 15.0cm



18.0160.01
 10x6mm



18.0160.02
 20x6mm

RETRACTORS

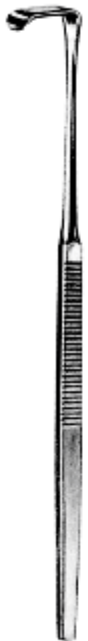

MINI-LANGENBECK
 16.0cm



18.0164.10
 10x6mm



18.0164.17
 17x5mm



18.0164.20
 20x6mm



18.0164.22
 22x8mm



18.0170.12
 12.0cm



14x8mm



18.0174.16
 16.0cm

RETRACTORS

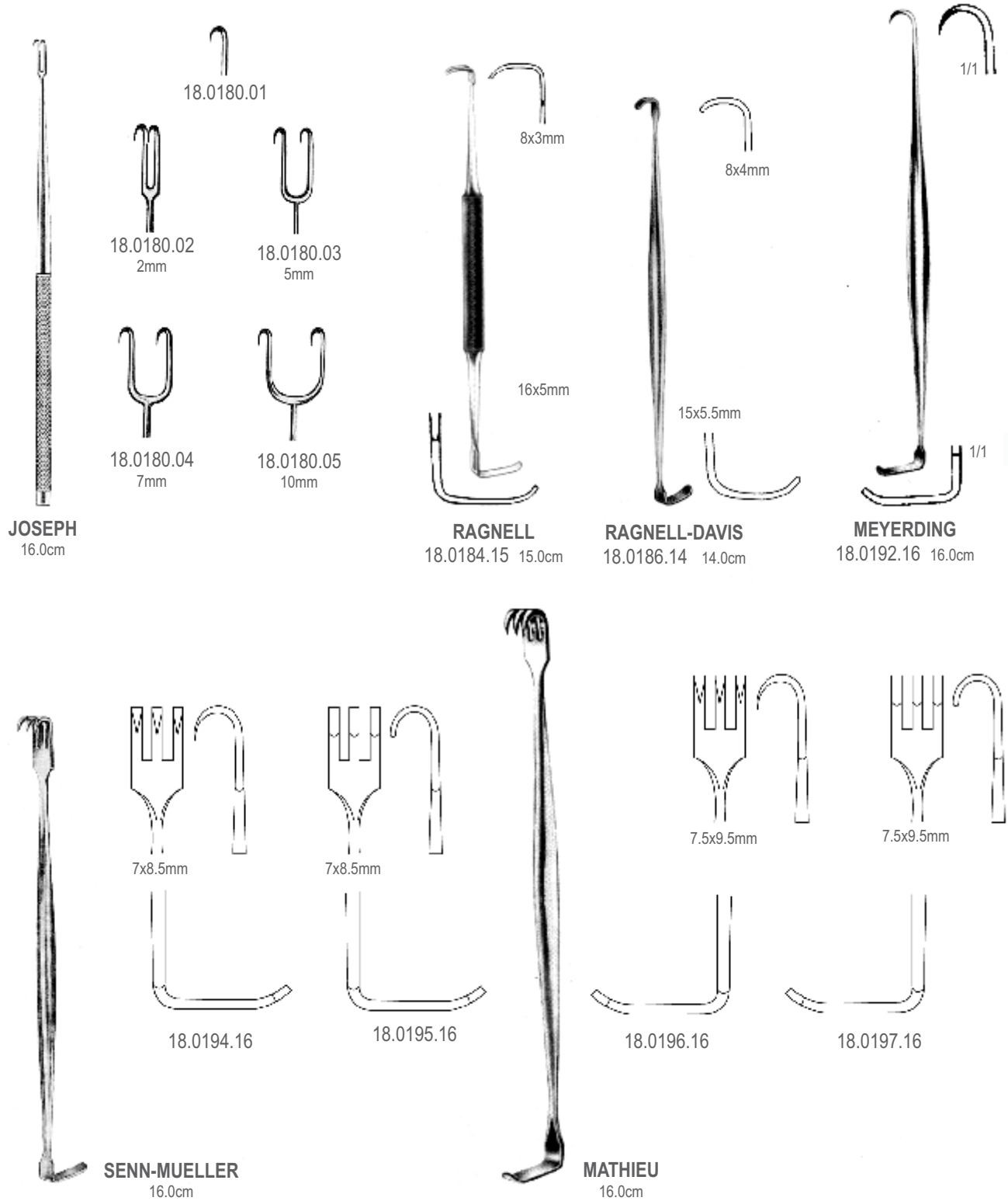

Retractors
Wundhaken
Separadores
Ретракторы хирургические
拉钩



CUSHING
18.0204.20 20.0cm



CUSHING
18.0206.20 20.0cm



CUSHING
18.0210.21 21.5cm



OLDBERG
20.0cm



18.0214.01



18.0214.02



18.0214.03



18.0214.04

RETRACTORS

RETRACTORS



VOLKMANN
11.5cm



VENENHAKEN BROM
19.0cm



STRANDELL-STILLE
19.0cm



VOLKMANN
23.0cm

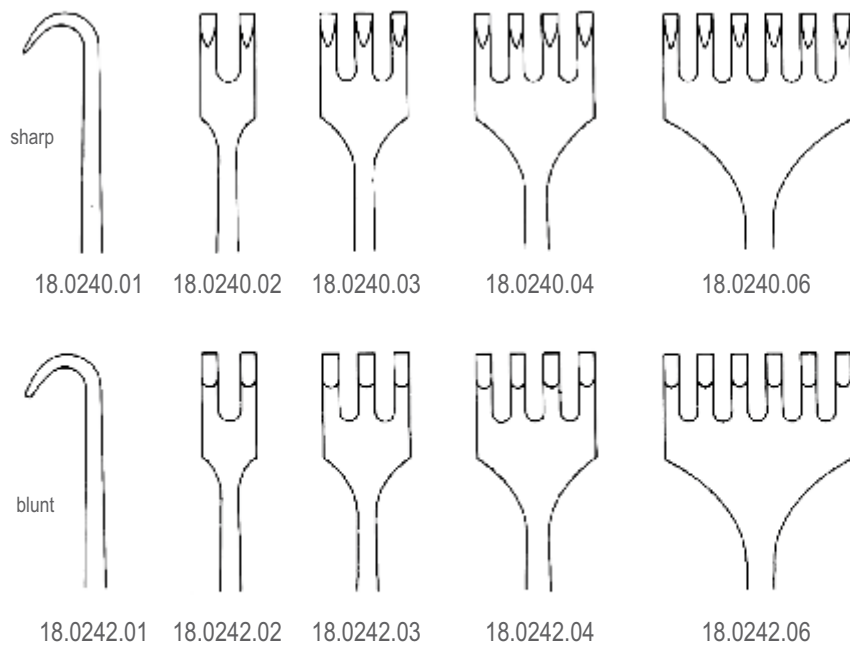



VOLKMANN
21.5cm



18.0250.01

18.0250.02

18.0250.03

18.0250.04

18.0250.06

sharp

18.0252.01

18.0252.02

18.0252.03

18.0252.04

18.0252.06

semi-sharp

18.0254.01

18.0254.02

18.0254.03

18.0254.04

18.0254.06

blunt



VOLKMANN
21.5cm

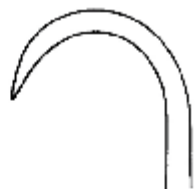

18.0260.21
sharp

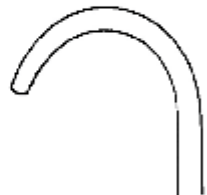

18.0262.21
blunt



VOLKMANN
20.0cm



18.0264.20
sharp



18.0266.20
blunt

RETRACTORS

RETRACTORS



KOCHER
22.0cm



22.0cm

Retractors
Wundhaken
Separadores
Ретракторы хирургические
拉钩

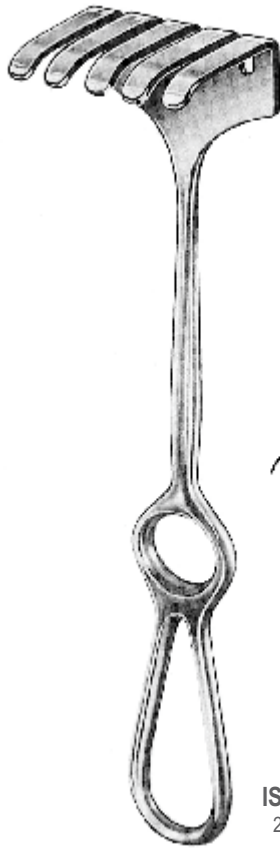

ISRAEL
25.0cm

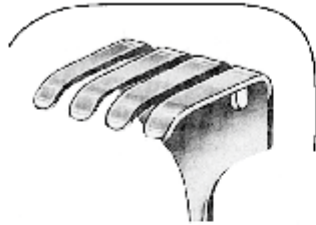

18.0290.01
40x40mm

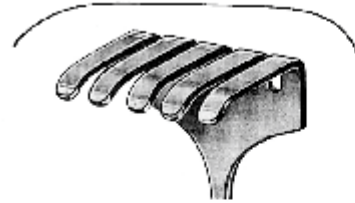

18.0290.02
45x50mm

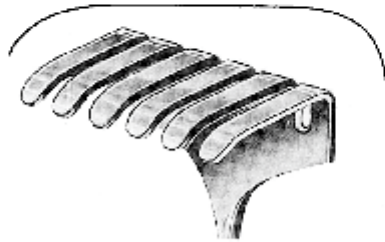

18.0290.03
50x60mm

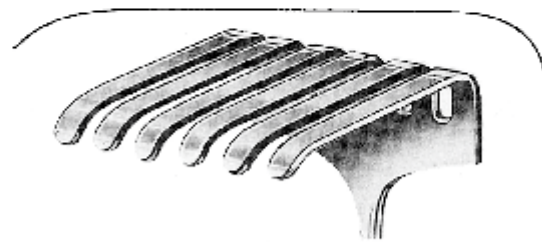

18.0290.04
70x70mm



WASSMUND
18.0294.20 20.0cm



18.0300.23
40x30mm
sharp



KOERTE
23.5cm

18.0302.23
40x30mm
blunt

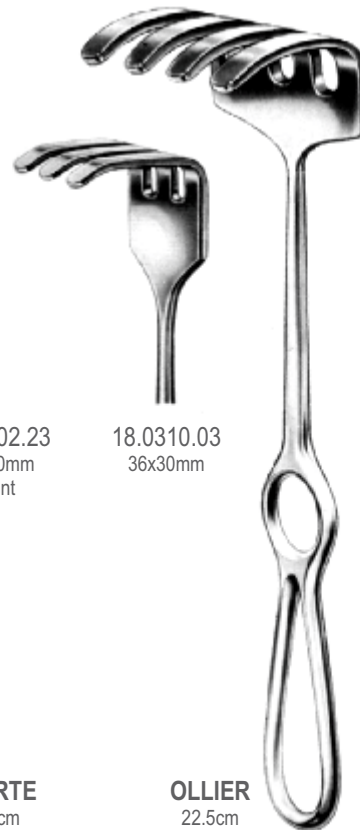

OLLIER
22.5cm

18.0310.03
36x30mm

18.0310.04
36x60mm

RETRACTORS

RETRACTORS



LANGENBECK

- 18.0314.01 22x6mm
- 18.0314.02 40x18mm
- 18.0314.03 44x13mm
- 18.0314.04 64x25mm

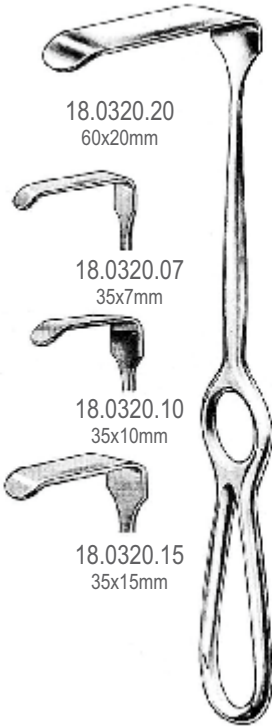

LANGENBECK
21.0cm

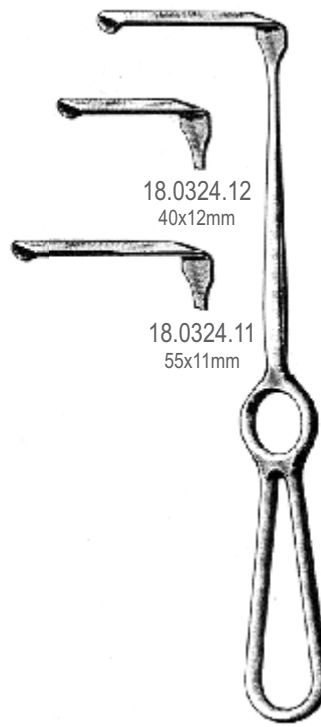

KOCHER
21.0cm



LAHEY
19.0cm

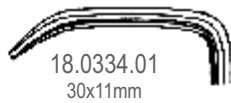

18.0334.01
30x11mm

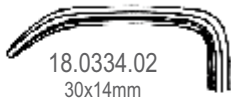

18.0334.02
30x14mm

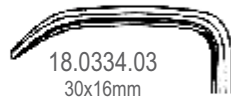

18.0334.03
30x16mm

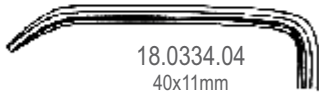

18.0334.04
40x11mm

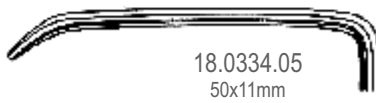

18.0334.05
50x11mm

LANGENBECK
21.0cm

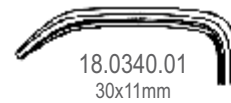

18.0340.01
30x11mm



18.0340.02
30x14mm



18.0340.03
30x16mm



18.0340.04
40x11mm

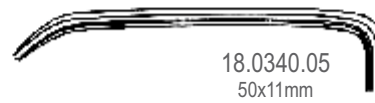

18.0340.05
50x11mm

LANGENBECK
22.0cm



Retractors
Wundhaken
Separadores
Ретракторы хирургические
拉钩

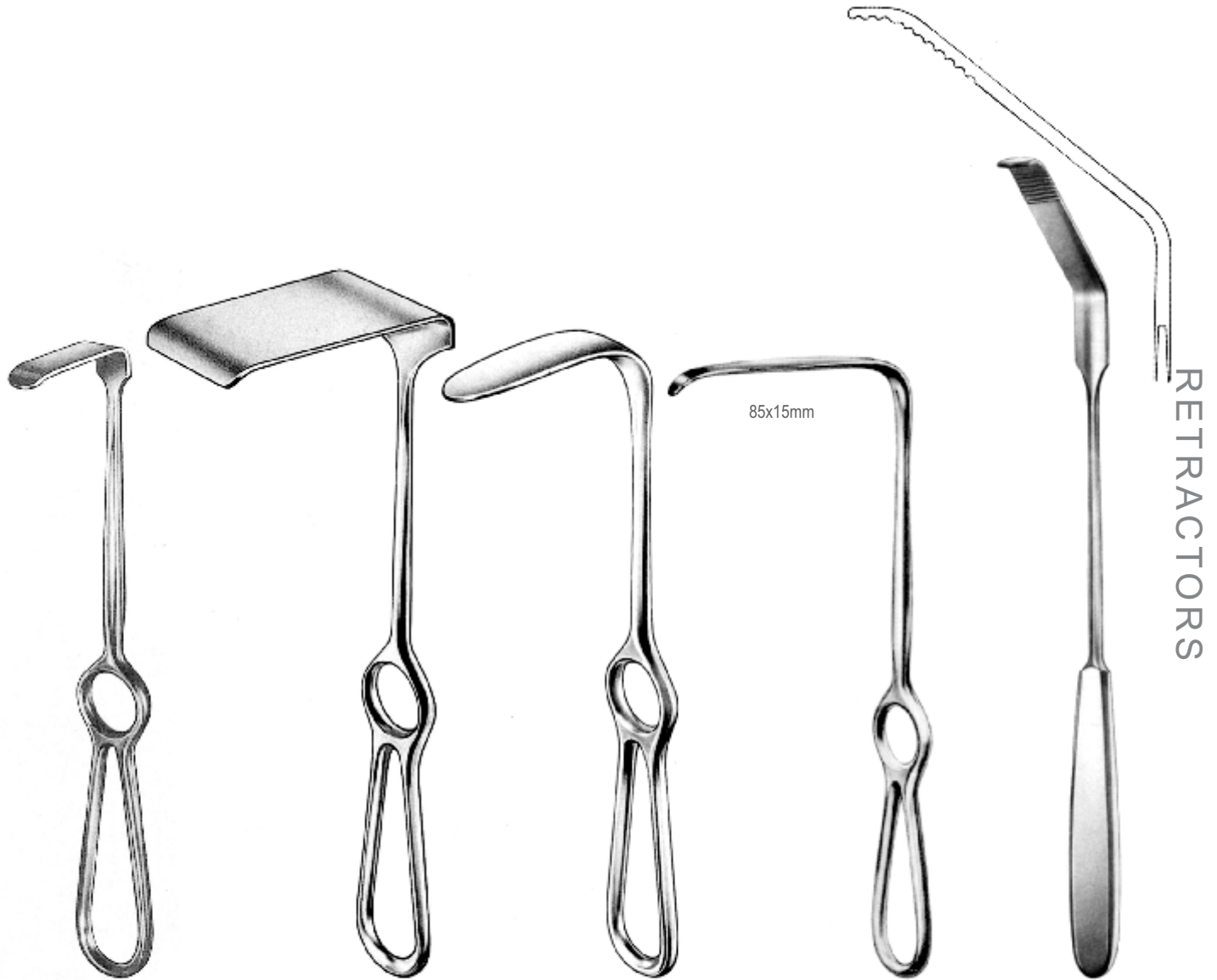

KOCHER-LANGENBECK

- 21.5cm
18.0344.01 25x06mm
18.0344.02 35x08mm
18.0344.03 35x11mm
18.0344.04 35x15mm
18.0344.05 40x11mm
18.0344.06 55x11mm
18.0344.07 70x14mm
18.0344.08 80x12mm
18.0344.09 80x16mm

KOCHER

- 23.0cm
18.0350.18 40x18mm
18.0350.20 60x20mm
18.0350.25 60x25mm
18.0350.30 75x30mm
18.0350.40 75x40mm

LANGENBECK

- 21.0cm
18.0354.55 55x20mm
18.0354.60 60x20mm
18.0354.63 63x20mm

LANGENBECK

- 18.0360.21 21.0cm

ZENKER

- 18.0366.35 35x8mm
18.0366.60 60x12mm
18.0366.75 75x12mm





GREEN
18.0410.22 22.0cm



DURHAM
18.0414.13 13mm
18.0414.19 19mm
18.0414.22 22mm



19x32mm

LONDON HOSPITAL
18.0420.23 23.0cm



18.0424.12 19x12mm
18.0424.14 21x14mm



KOCHER 22.0cm
18.0430.10 40x10mm
18.0430.15 40x15mm
18.0430.20 40x20mm



MIDDELDORPF

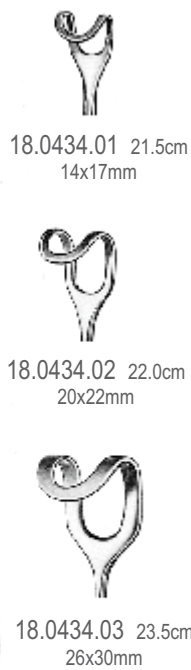

18.0434.01 21.5cm
14x17mm

18.0434.02 22.0cm
20x22mm

18.0434.03 23.5cm
26x30mm



MIDDELDORPF



18.0440.01 21.5cm
14x17mm

18.0440.02 22.0cm
20x22mm

18.0440.03 23.5cm
26x30mm



12x14mm

LITTLE
18.0444.20 20.0cm

RETRACTORS



52x22mm

RICHARDSON
18.0450.24 24.0cm

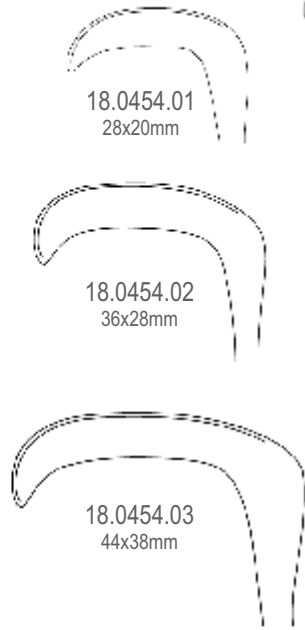

18.0454.01
28x20mm

18.0454.02
36x28mm

18.0454.03
44x38mm



RICHARDSON
24.0cm



RICHARDSON GRIP
18.0460.01 20x25mm
18.0460.02 25x31mm
18.0460.03 38x38mm
18.0460.04 19x51mm
18.0460.05 41x64mm



Fig.2=49x38mm
Fig.1=28x20mm

Fig.1=36x28mm
Fig.2=63x49mm

RICHARDSON-EASTMAN
18.0466.00 set
18.0466.01 Fig.1
18.0466.02 Fig.2



65x50mm

KELLY
18.0470.26
26.0cm

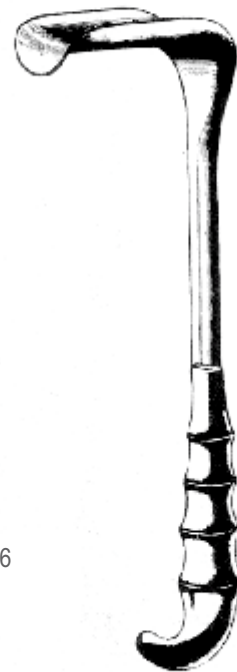

KELLY GRIP
18.0476.01 38x51mm
18.0476.02 51x64mm
18.0476.03 64x76mm
18.0476.04 70x82mm



RETRACTORS

RETRACTORS



25.0cm
18.0514.01 90x28mm
18.0514.02 105x30mm
18.0514.03 120x52mm

BRUNNER
25.0cm
18.0520.08 80x20mm
18.0520.10 100x20mm
18.0520.12 120x25mm
18.0520.13 130x30mm
18.0520.14 140x30mm
18.0520.16 160x30mm
18.0520.18 180x30mm

BRUNNER
25.0cm
18.0522.08 80x20mm
18.0522.10 100x20mm
18.0522.12 120x25mm
18.0522.14 140x25mm
18.0522.16 160x30mm
18.0522.18 180x30mm

HÖSEL
25.0cm
18.0526.01 60x20mm
18.0526.02 80x30mm
18.0526.03 100x30mm
18.0526.04 120x30mm
18.0526.05 140x30mm
18.0526.06 140x40mm



CORYLLOS
24.0cm



SAUERBRUCH
18.0534.25 25.0cm
125x37mm



MIKULICZ
26.0cm
18.0540.01 90x50mm
18.0540.02 95x35mm
18.0540.03 120x50mm
18.0540.04 150x50mm

KELLY
26.0cm
18.0544.01 190x38mm
18.0544.02 190x57mm
18.0544.03 220x38mm

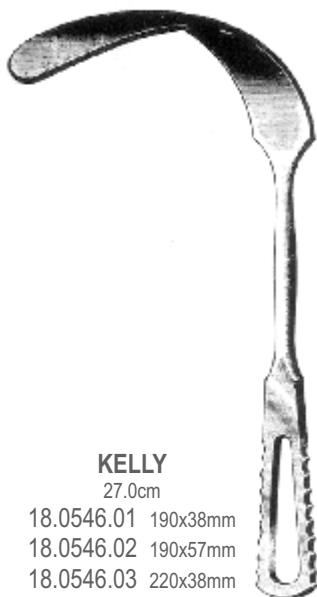

KELLY
27.0cm
18.0546.01 190x38mm
18.0546.02 190x57mm
18.0546.03 220x38mm



MIKULICZ
26.0cm
18.0550.01 95x35mm
18.0550.02 120x50mm
18.0550.03 150x50mm



MIKULICZ
with cold light guide
26.0cm
18.0554.01 95x35mm
18.0554.02 120x50mm
18.0554.03 150x50mm

RETRACTORS

RETRACTORS



BRUNNER
18.0560.24 24.0cm
145x25mm



BRUNNER
with cold light guide
18.0564.24 24.0cm
145x25mm



HOLMANN
40.0cm
18.0570.01 65mm,37.5cm
18.0570.02 110mm,40.0cm

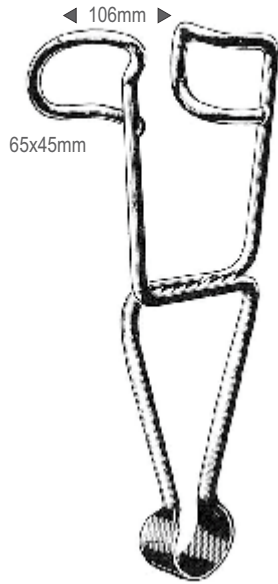

DARTIGUES
18.0574.26 26.0cm

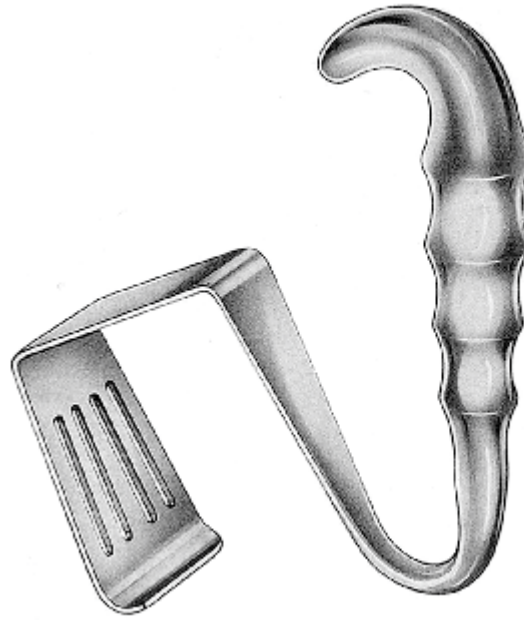

DAVIDSON
16.0cm
18.0580.01 75x50mm
18.0580.02 75x90mm

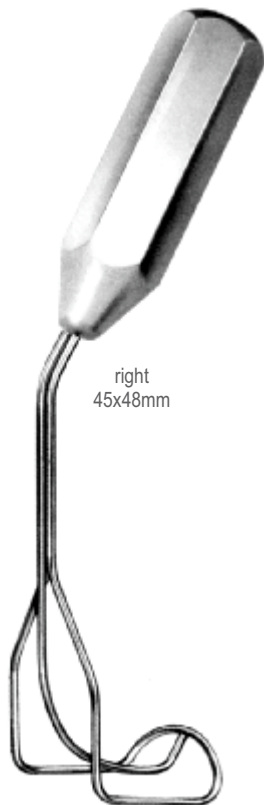

right
45x48mm

COOLEY
18.0590.21 21.5cm



right, serrated
45x48mm

COOLEY
18.0592.21 21.5cm



left
45x48mm

COOLEY
18.0594.23 23.0cm

RETRACTORS

RETRACTORS



DEAVER
18.0600.01 18.0cm

DEAVER
18.0600.02 21.5cm

DEAVER
18.0600.03 23.0cm

DEAVER
18.0600.04 30.0cm

DEAVER
18.0600.05 33.0cm

DEAVER
18.0600.06 36.0cm

Retractors
Wundhaken
Separadores
Ретракторы хирургические
拉钩



DEAVER
18.0600.07 30.0cm

DEAVER
18.0600.08 30.0cm

DEAVER
18.0600.09 30.0cm

DEAVER GRIP
31.0cm
18.0604.01 25mm
18.0604.02 38mm
18.0604.03 50mm
18.0604.04 100mm

RETRACTORS

RETRACTORS



POLLOSON
18.0610.27 27.0cm

POLLOSON
18.0614.27 27.0cm

HARRINGTON
32.0cm
18.0620.01 127x40mm
18.0620.02 127x62mm



ROSS
27.0cm



Fig.1
18.0624.01



Fig.2
18.0624.02



Fig.3
18.0624.03



Fig.4
18.0624.04



Fig.5
18.0624.05



Fig.6
18.0624.06



CRAWFORD
19.0cm
18.0630.01 15x15mm
18.0630.02 15x23mm

RETRACTORS



(Flexible)

18.0670.25 33.0cm, 25mm
18.0670.30 33.0cm, 30mm
18.0670.40 33.0cm, 40mm
18.0670.50 33.0cm, 50mm



HABERER (Flexible)

18.0674.20 20.0cm, 17/25mm
18.0674.28 28.0cm, 25/30mm
18.0674.30 30.0cm, 37/45mm



RIBBON

18.0680.06 200x6.0mm
18.0680.09 200x9.0mm
18.0680.12 200x12mm
18.0680.17 200x17mm
18.0680.20 200x20mm
18.0680.25 200x25mm
18.0680.26 250x25mm

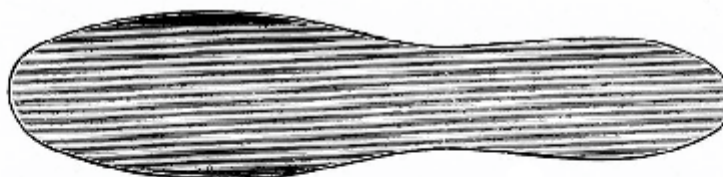

REVERDIN

18.0690.29 29.0cm



REVERDIN

18.0696.28 28.0cm



SURGICAL
INSTRUMENTS



THE ULTIMATE CHOICE

Hilton
PREMIUM STAINLESS STEEL



THE ULTIMATE CHOICE

SELF-RETAINING RETRACTOR

Self Retaining Retractors
Wundspreizer, Selbsthalend
Separadores con retenida automatica
РАНОРАСШИРИТЕЛИ САМОУДЕРЖИВАЮЩИЕСЯ
自护拉钩

Self Retaining Retractors
Wundspreizer, Selbsthalend
Separadores con retenida automatica
Ранорасширители самоудерживающиеся
牵开器



LOGAN
19.0010.04 4.0cm



BUCKLEY
19.0014.06 6.0cm



19.0020.08 8.0cm

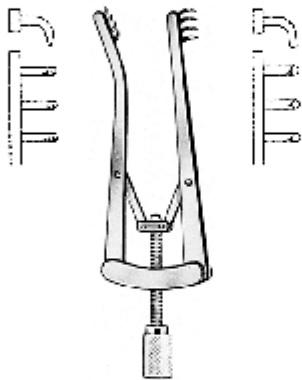

ALM
sharp 19.0030.07 7.0cm
blunt 19.0032.07 7.0cm
sharp 19.0030.10 10.0cm
blunt 19.0032.10 10.0cm

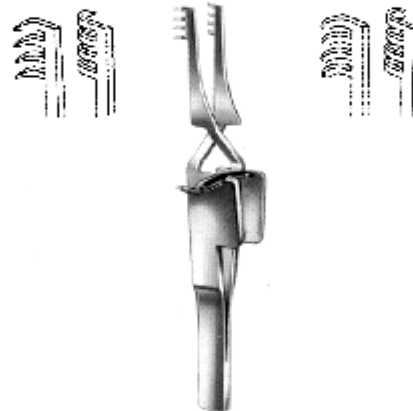

KAUPP
shrap 19.0040.10 10.0cm
blunt 19.0042.10 10.0cm



FINSEN
sharp 19.0050.05 5.0cm
blunt 19.0052.05 5.0cm
sharp 19.0050.07 7.0cm
blunt 19.0052.07 7.0cm

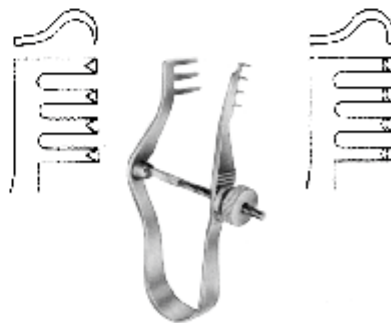

FINSEN
sharp 19.0054.05 5.0cm
blunt 19.0056.05 5.0cm
sharp 19.0054.07 7.0cm
blunt 19.0056.07 7.0cm

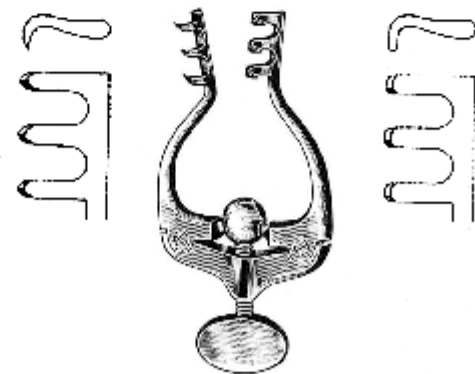

JANSEN
sharp 19.0060.10 10.0cm
blunt 19.0062.10 10.0cm

RETRACTORS



VICKERS
19.0070.00 5.0cm



VICKERS 7.5cm
19.0072.00 complete with central blade
19.0072.01 10x12mm
19.0072.02 10x18mm



VICKERS 7.5cm
19.0074.00 complete with central blade
19.0072.01 10x12mm
19.0072.02 10x18mm

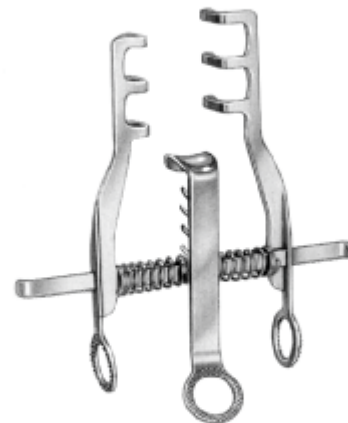

VICKERS 9.0cm
19.0076.00 complete with central blade
19.0072.01 10x12mm
19.0072.02 10x18mm

Self Retaining Retractors
Wundspreizer, Selbsthalend
Separadores con retenida automatica
Ранорасширители самоудерживающиеся
牵开器



WEITLANER-LOKTITE
sharp blunt
19.0080.10 10.5cm 19.0082.10

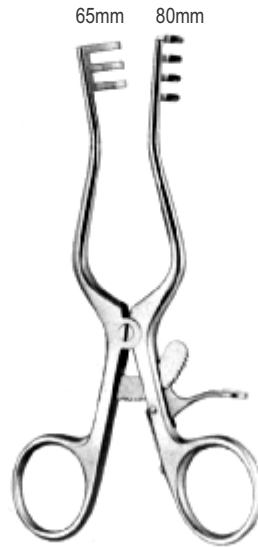

WEITLANER
sharp blunt
19.0084.13 13.0cm 19.0086.13
19.0084.14 14.0cm 19.0086.14
19.0084.16 16.0cm 19.0086.16

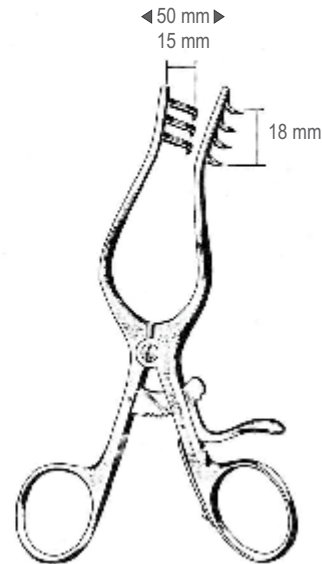

WEITLANER-WULLSTEIN
sharp blunt
19.0088.13 13.0cm 19.0089.13



WEITLANER-WULLSTEIN
sharp blunt
19.0090.13 13.0cm 19.0092.13



WEITLANER
sharp blunt
19.0094.20 20.0cm 19.0096.20
19.0094.23 23.0cm 19.0096.23
19.0094.26 26.0cm 19.0096.26



TRAVERS
19.0100.20 20.0cm
19.0100.21 21.0cm

RETRACTORS

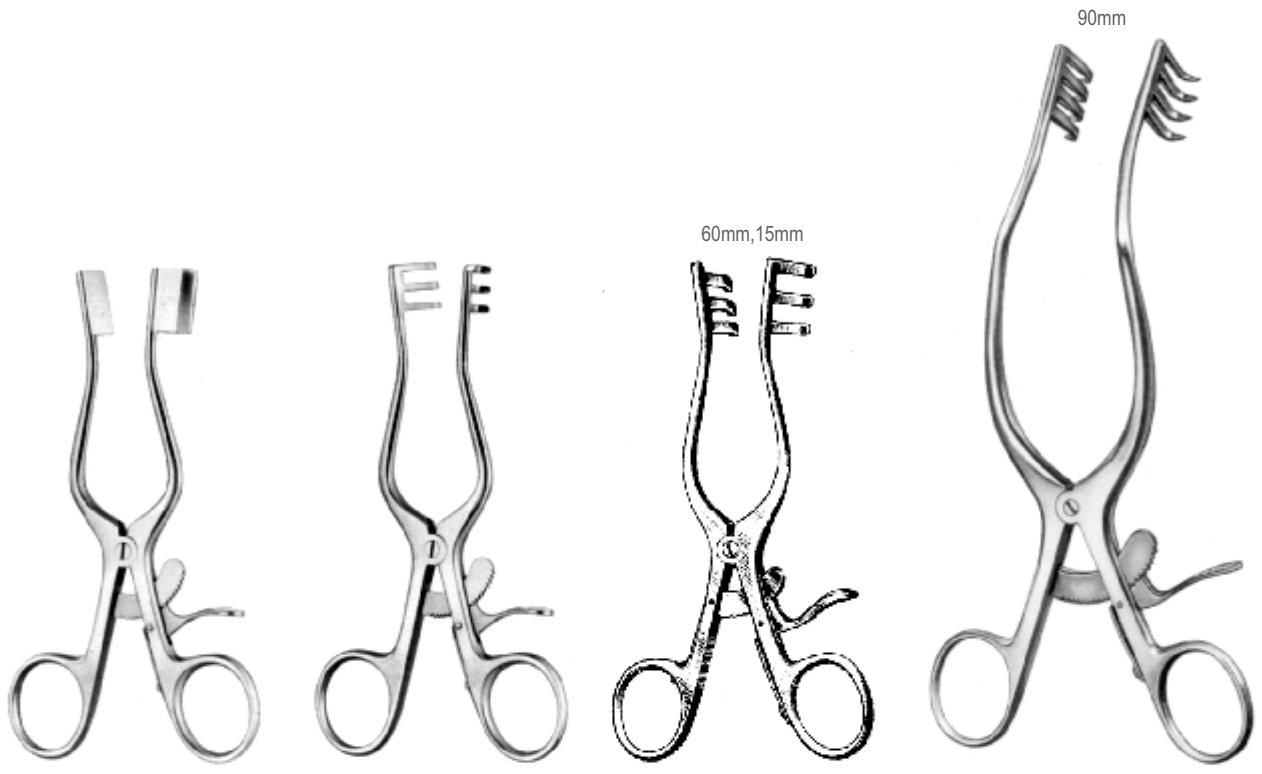

WEITLANER-BABY
19.0104.13 13.0cm

MILLIGAN
19.0110.13 13.0cm

WEST
sharp 19.0114.13
blunt 19.0116.13
60mm, 15mm

ANDERSON-ADSON
19.0120.19 19.5cm
90mm



PLESTER
sharp 19.0124.13
blunt 19.0126.13
13.0cm



PLESTER
19.0130.11 11.0cm



PLESTER
19.0132.11 11.0cm

Self Retaining Retractors
Wundspreizer, Selbsthalend
Separadores con retenida automatica
Ранорасширители самоудерживающиеся
牵开器



SCALP CONTOUR
sharp blunt
19.0140.14 14.0cm 19.0142.14



MOLLISON
19.0150.16 16.5cm



MOLLISON
19.0152.15 15.0cm

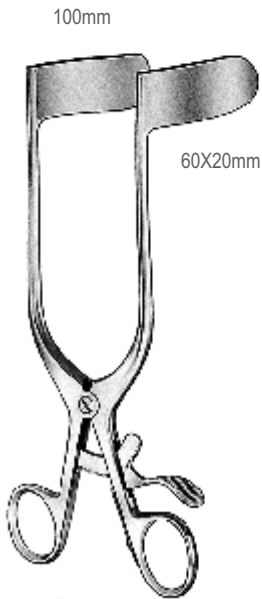

RIGBY
19.0156.18 18.0cm



MAYO-ADAMS
19.0160.17 17.0cm

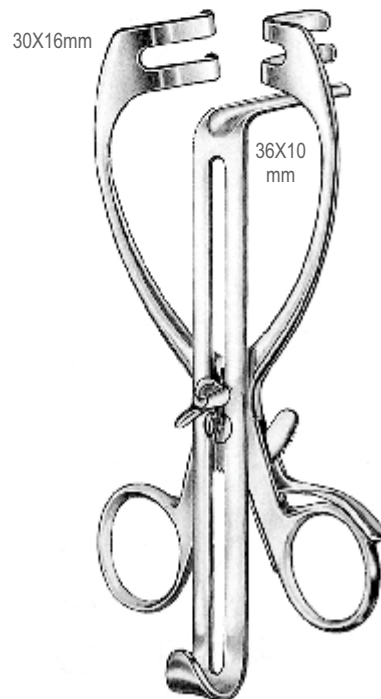

MAYO-ADAMS
19.0162.17 17.0cm

RETRACTORS

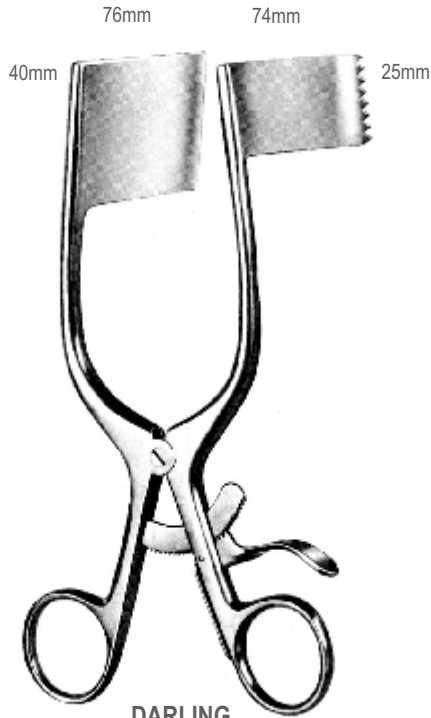

DARLING
19.0170.18 18cm

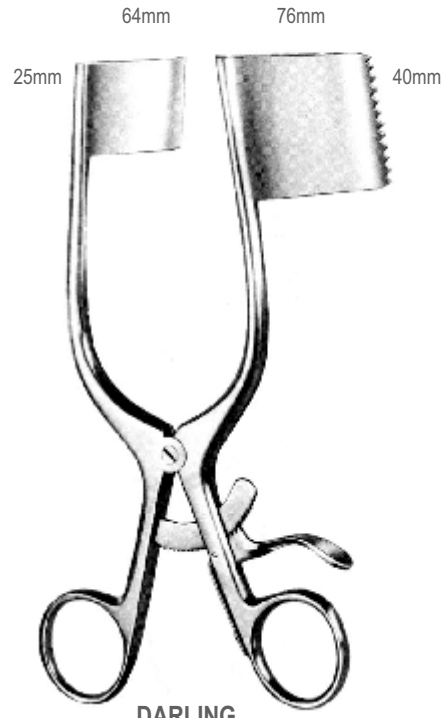

DARLING
19.0172.18 18cm



HENLEY
sharp 19.0176.01 16.5cm
blunt 19.0176.02



centre blade
19.0176.19
16x19mm



centre blade
19.0176.25
16x25mm

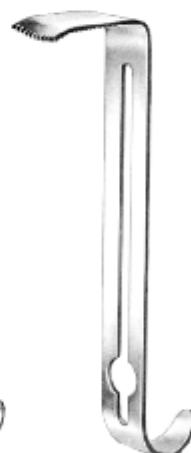

centre blade
19.0176.32
16x32mm

Self Retaining Retractors
Wundspreizer, Selbsthalend
Separadores con retenida automatica
Ранорасширители самоудерживающиеся
牵开器



GELPI-LOKTITE
19.0180.13 13.0cm



GELPI
19.0182.09 09.0cm
19.0182.14 14.0cm
19.0182.16 16.0cm
19.0182.18 18.0cm



GELPI
19.0186.18 18.0cm



GELPI-SEILETZ
19.0190.15 15.0cm



GELPI-LOKTITE
19.0194.18 18.0cm



GELPI-LOKTITE
19.0196.18 18.0cm

RETRACTORS

RETRACTORS



NORFOLK-NORWICH
19.0200.22 22.0cm



27.0cm

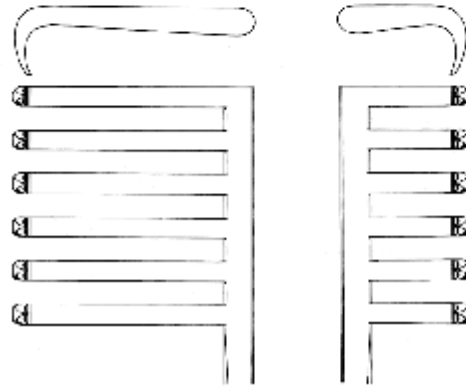

19.0204.01

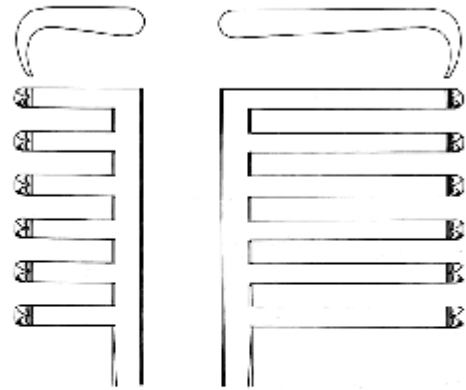

19.0204.02

Self Retaining Retractors
 Wundspreizer, Selbsthalend
 Separadores con retenida automatica
 Ранорасширители самоудерживающиеся
 牵开器



RETRACTORS

ADSON

sharp		blunt
19.0210.13	13.0cm	19.0212.13
19.0210.16	16.0cm	19.0212.16
19.0210.20	20.0cm	19.0212.20
19.0210.26	26.0cm	19.0212.26

ADSON

19.0216.32 32.0cm

HARVEY JACKSON

19.0220.28 28.0cm

RETRACTORS



BECKMANN
19.0224.31 31.0cm

BECKMANN-EATON
19.0230.32 32.0cm

BECKMANN-ADSON
sharp 31.0cm blunt
19.0234.01 27x27mm 19.0236.01
19.0234.02 46x27mm 19.0236.02

Self Retaining Retractors
 Wundspreizer, Selbsthalend
 Separadores con retenida automatica
 Ранорасширители самоудерживающиеся
 牵开器



RETRACTORS



CLOWARD
 16.0cm
 19.0240.00 complete
 19.0240.01 frame



CLOWARD
 25.0cm
 19.0242.00 complete
 19.0242.01 frame



CLOWARD-HOEN
 23.0cm
 19.0244.00 complete
 19.0244.01 frame



19.0246.40
 19.0246.45
 19.0246.50
 19.0246.55
 19.0246.60

40x16mm
 45x16mm
 50x16mm
 55x16mm
 60x16mm



19.0248.40
 19.0248.45
 19.0248.50
 19.0248.55
 19.0248.60



CASPAR
19.0254.00 complete
19.0254.17 without blade

- 19.0254.40 40mm
- 19.0254.45 45mm
- 19.0254.50 50mm
- 19.0254.55 55mm
- 19.0254.60 60mm
- 19.0254.65 65mm
- 19.0254.70 70mm

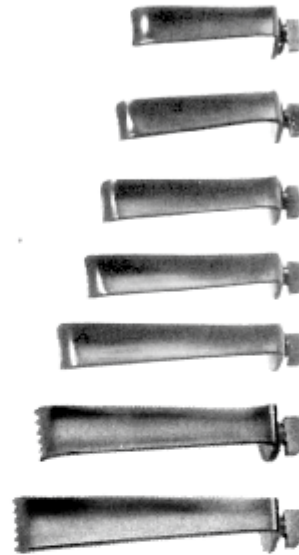

CASPAR
19.0260.45 - 19.0260.65



- 19.0260.45 45mm
- 19.0260.50 50mm
- 19.0260.55 55mm
- 19.0260.60 60mm
- 19.0260.65 65mm

Self Retaining Retractors
 Wundspreizer, Selbsthalend
 Separadores con retenida automatica
 Ранорасширители самоудерживающиеся
 牵开器



CASPAR



- 19.0262.40 40mm
- 19.0262.45 45mm
- 19.0262.50 50mm
- 19.0262.55 55mm
- 19.0262.60 60mm
- 19.0262.65 65mm
- 19.0262.75 75mm
- 19.0262.85 85mm



BLADE EJECTOR
 19.0266.11 11.5cm

RETRACTORS



CASPAR
 19.0270.00

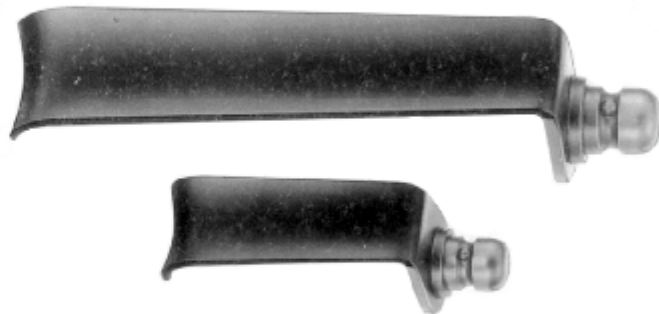

- 19.0270.35 35mm
- 19.0270.40 40mm
- 19.0270.45 45mm
- 19.0270.50 50mm
- 19.0270.55 55mm
- 19.0270.60 60mm
- 19.0270.65 65mm
- 19.0270.75 75mm
- 19.0270.85 85mm



CASPAR
19.0274.00 complete
19.0274.15 without blade



CASPAR
19.0276.00 complete
19.0276.15 without blade

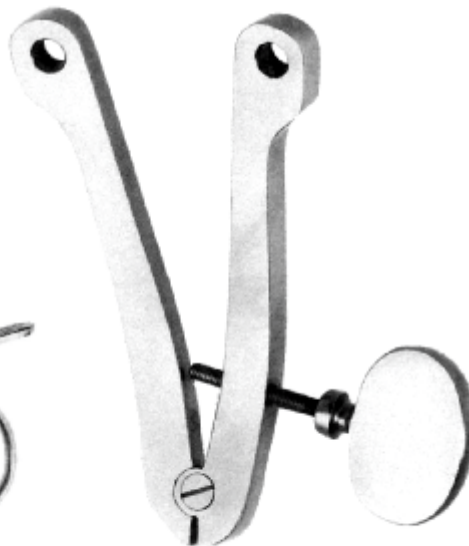

CASPAR
19.0280.00 complete
19.0280.01 without blade

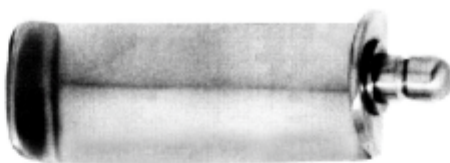

19.0282.45 45x20mm
19.0282.50 50x20mm
19.0282.55 55x20mm
19.0282.60 60x20mm
19.0282.65 65x20mm



19.0284.40 40x20mm
19.0284.45 45x20mm
19.0284.50 50x20mm
19.0284.55 55x20mm
19.0284.60 60x20mm

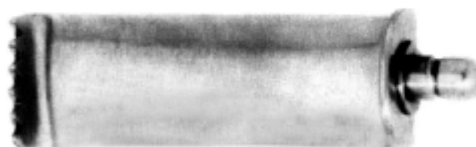

19.0286.40 40x20mm
19.0286.45 45x20mm
19.0286.50 50x20mm
19.0286.55 55x20mm
19.0286.60 60x20mm

Self Retaining Retractors
Wundspreizer, Selbsthalend
Separadores con retenida automatica
Ранорасширители самоудерживающиеся
牵开器



CASPAR
19.0290.00 complete
19.0290.01 without blade
115mmx85mm



CASPAR
19.0294.00 complete
19.0294.01 without blade
165mmx90mm

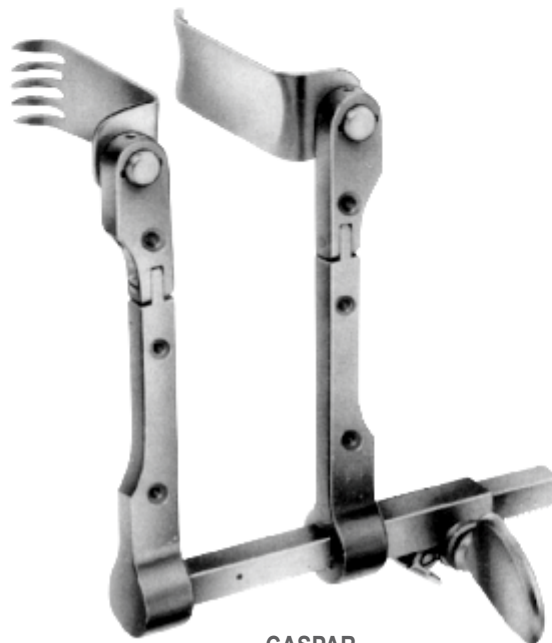

CASPAR
19.0300.00 complete
19.0300.01 without blade
120mmx90mm

RETRACTORS

Exchangeable Blades
Wechselvalven
Valvas intercambiables
Зеркала сменные к ранорасширителям
可更换刀片

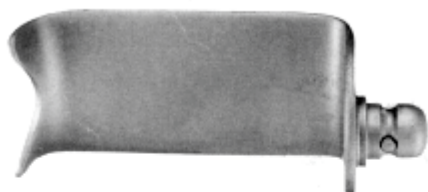

S.STEEL	TITANIUM	
19.0310.30	30x24mm	19.9310.30
19.0310.35	35x24mm	19.9310.35
19.0310.40	40x24mm	19.9310.40
19.0310.45	45x24mm	19.9310.45
19.0310.50	50x24mm	19.9310.50
19.0310.55	55x24mm	19.9310.55
19.0310.60	60x24mm	19.9310.60
19.0310.65	65x24mm	19.9310.65
19.0310.70	70x24mm	19.9310.70
19.0310.75	75x24mm	19.9310.75

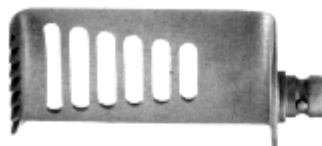

S.STEEL	TITANIUM	
19.0316.25	25x24mm	19.9316.25
19.0316.30	30x24mm	19.9316.30
19.0316.35	35x24mm	19.9316.35
19.0316.40	40x24mm	19.9316.40
19.0316.45	45x24mm	19.9316.45
19.0316.50	50x24mm	19.9316.50
19.0316.55	55x24mm	19.9316.55
19.0316.60	60x24mm	19.9316.60
19.0316.65	65x24mm	19.9316.65
19.0316.70	70x24mm	19.9316.70

RETRACTORS



S.STEEL	TITANIUM	
19.0312.30	30x23mm	19.9312.30
19.0312.35	35x23mm	19.9312.35
19.0312.40	40x23mm	19.9312.40
19.0312.45	45x23mm	19.9312.45
19.0312.50	50x23mm	19.9312.50
19.0312.55	55x23mm	19.9312.55
19.0312.60	60x23mm	19.9312.60
19.0312.65	65x23mm	19.9312.65
19.0312.70	70x23mm	19.9312.70
19.0312.75	75x23mm	19.9312.75

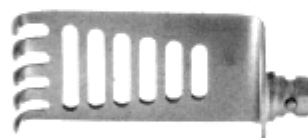

S.STEEL	TITANIUM	
19.0318.25	25x24mm	19.9318.25
19.0318.30	30x24mm	19.9318.30
19.0318.35	35x24mm	19.9318.35
19.0318.40	40x24mm	19.9318.40
19.0318.45	45x24mm	19.9318.45
19.0318.50	50x24mm	19.9318.50
19.0318.55	55x24mm	19.9318.55
19.0318.60	60x24mm	19.9318.60
19.0318.65	65x24mm	19.9318.65
19.0318.70	70x24mm	19.9318.70



S.STEEL	TITANIUM	
19.0314.30	30x23mm	19.9314.30
19.0314.35	35x23mm	19.9314.35
19.0314.40	40x23mm	19.9314.40
19.0314.45	45x23mm	19.9314.45
19.0314.50	50x23mm	19.9314.50
19.0314.55	55x23mm	19.9314.55
19.0314.60	60x23mm	19.9314.60
19.0314.65	65x23mm	19.9314.65
19.0314.70	70x23mm	19.9314.70
19.0314.75	75x23mm	19.9314.75



S.STEEL	TITANIUM	
19.0320.50	50x25mm	19.9320.50
19.0320.60	60x25mm	19.9320.60

Laminectomy Retractors
 Laminektomiespreizer
 Separadores para laminectomia
 Ранорасширители для ламинэктомии
 椎板牵开器



CASPAR
 19.0340.00 complete
 19.0340.01 without blades



CASPAR
 19.0344.00 complete
 19.0344.01 without blades



CASPAR
 19.0350.50 50mm



CASPAR
 19.0350.70 70mm



- 19.0352.35 35x22mm
- 19.0352.40 40x22mm
- 19.0352.45 45x22mm
- 19.0352.50 50x22mm
- 19.0352.55 55x22mm
- 19.0352.60 60x22mm
- 19.0352.65 65x22mm
- 19.0352.70 70x22mm

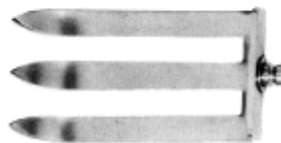

- 19.0354.35 35x37mm
- 19.0354.40 40x37mm
- 19.0354.45 45x37mm
- 19.0354.50 50x37mm
- 19.0354.55 55x37mm
- 19.0354.60 60x37mm
- 19.0354.65 65x37mm
- 19.0354.70 70x37mm

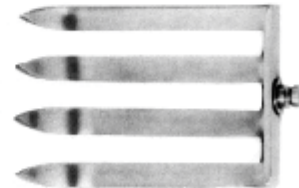

- 19.0356.35 35x52mm
- 19.0356.40 40x52mm
- 19.0356.45 45x52mm
- 19.0356.50 50x52mm
- 19.0356.55 55x52mm
- 19.0356.60 60x52mm
- 19.0356.65 65x52mm
- 19.0356.70 70x52mm

RETRACTORS

RETRACTORS



TEMPLE-FAY
19.0360.00
48x40x110mm



19.0364.01 45mm 19.0364.03 45mm
19.0364.02 60mm 19.0364.04 60mm

19.0364.05 60mm

TEMPLE-FAY-ULRICH
19.0364.00



BADGLEY
19.0370.00 55x44x165 mm
19.0372.00 60x44x165 mm

Laminectomy Retractors
 Laminektomiespreizer
 Separadores para laminectomia
 Ранорасширители для ламинэктомии, Зеркала сменные к ранорасширителям
 椎板牵开器



SCOVILLE
 19.0380.00 frame only

SCOVILLE-HAVERFIELD
 19.0382.00 frame only



SCOVILLE
 19.0384.50
 50mm



SCOVILLE
 19.0384.70
 70mm



SCOVILLE
 19.0386.50
 50mm



SCOVILLE
 19.0386.70
 70mm



SCOVILLE
 19.0388.01 64x25mm
 19.0388.02 64x50mm
 19.0388.03 88x25mm



SCOVILLE
 19.0390.01 41x38mm
 19.0390.02 67x44mm



TAYLOR
 19.0392.01 48x50mm
 19.0392.02 64x50mm
 19.0392.03 64x64mm
 19.0392.04 80x57mm

RETRACTORS

Abdominal Retractors
Bauchdeckenhalter
Separadores abdominales
Ранорасширители абдоминальные
腹部牵开器

RETRACTORS



COLLIN
19.0400.00
with 1 pair of blades
38x60mm



COLLIN
lateral blades
38x60mm 19.0402.00
38x80mm 19.0404.00
central blades
38x55mm
50x76mm

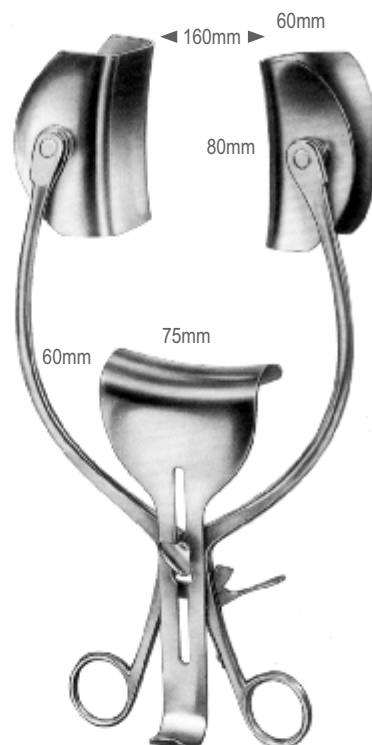

COLLIN
26.0cm
complete 19.0406.00
central blade 60x75mm 19.0406.01



BABY-COLLIN
19.0410.00
complete set with 2 pairs of blades



COLLIN lateral blades
19.0410.18 18x40mm
19.0410.27 27x40mm



RICARD complete
19.0420.00 28.0cm
19.0422.00 30.0cm
sepreader only
19.0424.01
central blades
19.0426.01 55x70mm
19.0426.02 80x90mm
lateral blades
19.0430.40 50x58mm
19.0430.45 60x80mm
19.0430.60 72x85mm

Exchangeable Lateral Blades For Abdominal Retractors and Ribs Spreaders

Austauschbare Seitenvalen für Bauchdeckenhalter und Rippensperrer

Valvas laterales intercambiables para separadores abdominales y de costillas

Ранорасширители абдоминальные, Зеркала сменные к ранорасширителям и Ранорасширители реберные

腹部牵开器及叶片

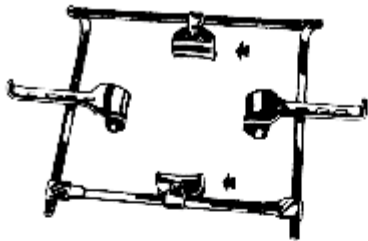

19.0430.45



19.0410.00



19.0400.00



- 19.0428.50 18x40mm
- 19.0428.52 27x40mm
- 19.0428.70 38x60mm
- 19.0428.80 40x80mm
- 19.0428.90 45x80mm
- 19.0428.92 50x70mm
- 19.0428.94 60x80mm

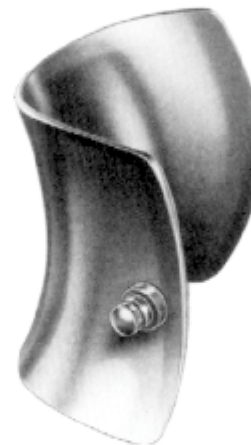

- 19.0430.18 50x70mm
- 19.0430.27 52x110mm
- 19.0430.38 70x55mm
- 19.0430.39 80x90mm
- 19.0430.40 50x58mm
- 19.0430.45 60x80mm
- 19.0430.60 72x85mm

RETRACTORS



19.0402.00
19.0404.00



19.0406.00



19.0420.00
19.0422.00

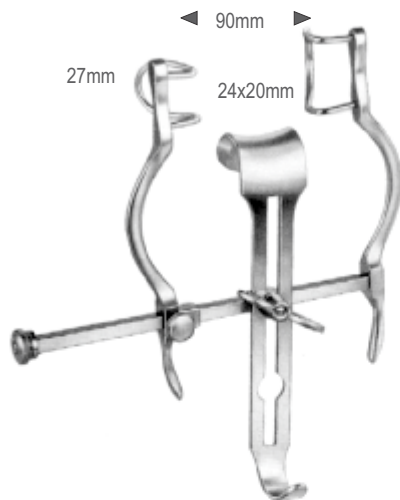

BALFOUR-BABY

19.0440.00 complete
19.0440.24 centre blade

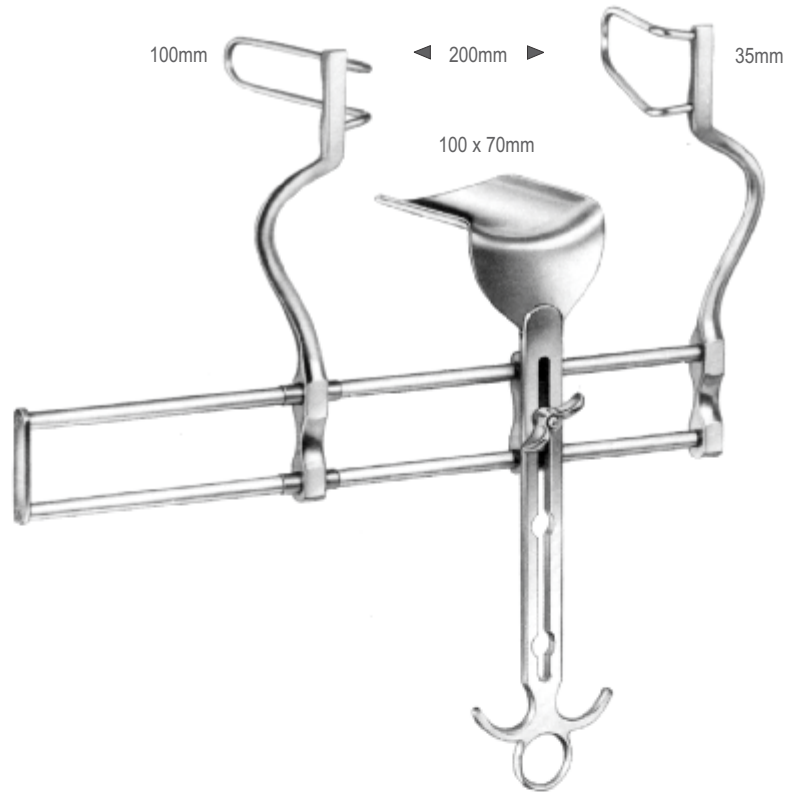

BALFOUR

19.0442.00 complete
19.0442.10 centre blade



BALFOUR

19.0444.00 complete
19.0444.45 centre blade

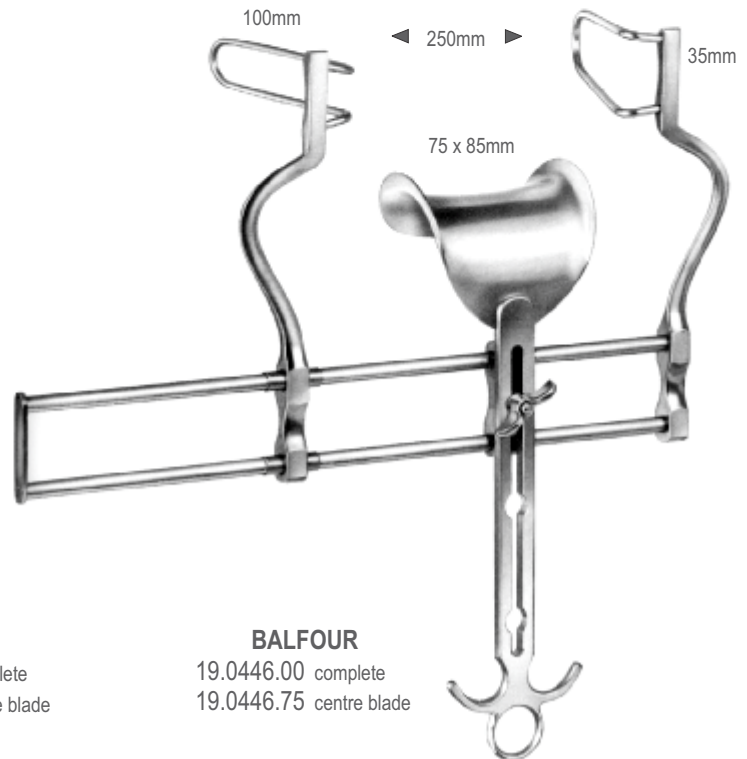

BALFOUR

19.0446.00 complete
19.0446.75 centre blade

Abdominal Retractors
 Bauchdeckenhalter
 Separadores abdominales
 Ранорасширители абдоминальные
 腹壁牵开器



BERKELEY

- 19.0450.00 complete
- 19.0450.60 2 blades 60 x 35mm

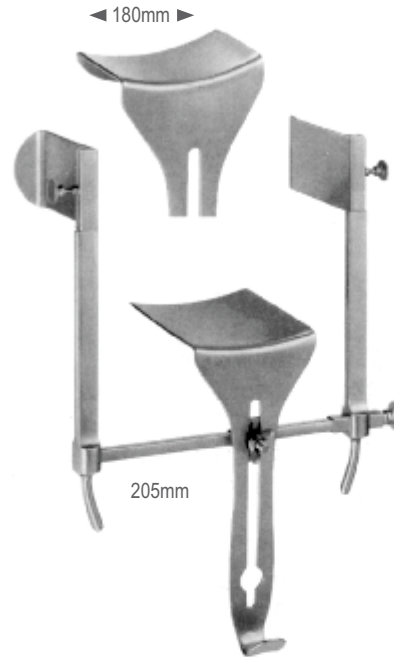

GOLIGHER

- 19.0454.00 complete
- 19.0454.51 1 centre blade 51mm deep
- 19.0454.10 1 pair lateral blades 51mm deep
- 19.0456.51 1 centre blade 102mm deep
- 19.0456.10 1 pair lateral blades 102mm deep

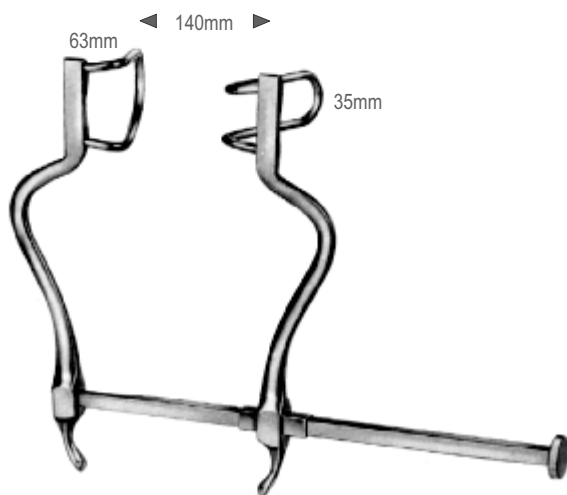

GOSSET
19.0460.00

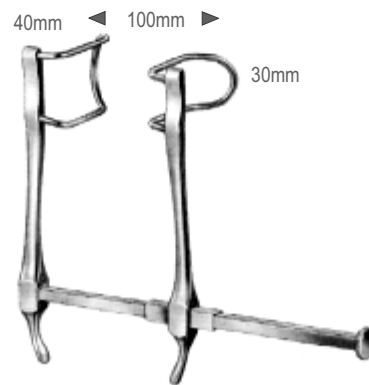

GOSSET
19.0462.00

RETRACTORS



GOSSET
19.0464.00 complete
19.0464.16 central blade

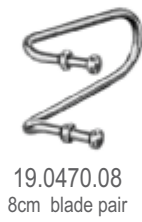

BALFOUR US-TYPE
19.0470.00

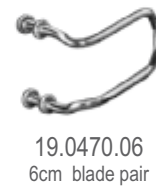

Center Blade Only
Mittelblatt allein
Valva central suelta
Зеркала сменные к ранорасширителям
中心刀片只



BALFOUR
19.0480.80 80x90mm

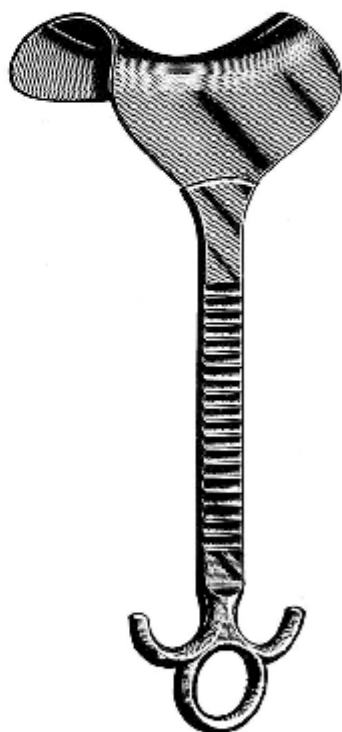

DOYEN
19.0482.95 55x95mm
19.0482.10 55x105mm
19.0482.11 55x115mm
19.0482.12 55x125mm



BALFOUR
19.0484.40 40x68mm
19.0484.68 68x85mm



BALFOUR
19.0486.68 68x85mm

RETRACTORS

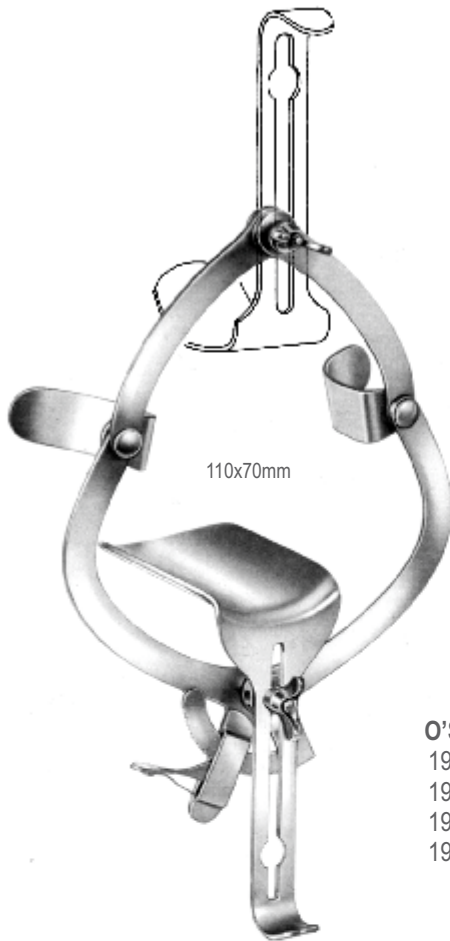

O'SULLIVAN-O'CONNOR

- 19.0490.00 set
- 19.0490.01 frame
- 19.0490.02 blade
- 19.0490.03 blade 110x70mm



19.0490.04
80x45mm

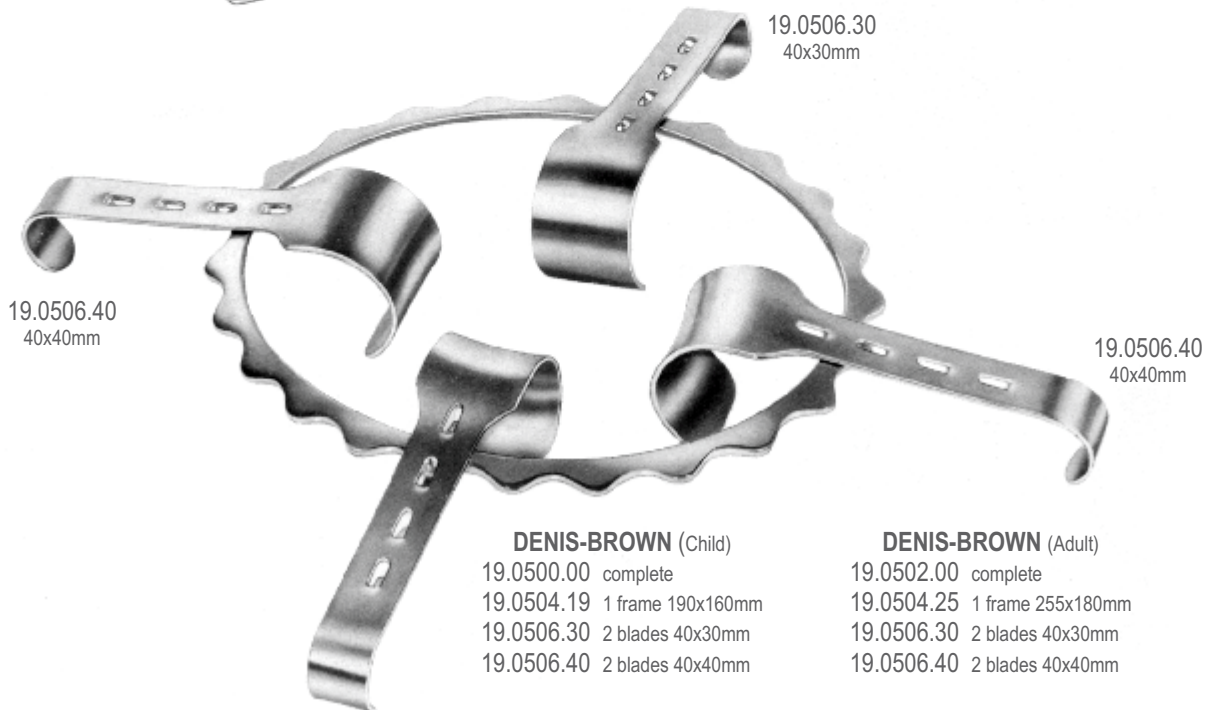

DENIS-BROWN (Child)

- 19.0500.00 complete
- 19.0504.19 1 frame 190x160mm
- 19.0506.30 2 blades 40x30mm
- 19.0506.40 2 blades 40x40mm

DENIS-BROWN (Adult)

- 19.0502.00 complete
- 19.0504.25 1 frame 255x180mm
- 19.0506.30 2 blades 40x30mm
- 19.0506.40 2 blades 40x40mm

19.0506.30
40x30mm

Abdominal Retractors
 Bauchdeckenhalter
 Separadores abdominales
 Ранорасширители абдоминальные
 腹部牵开器

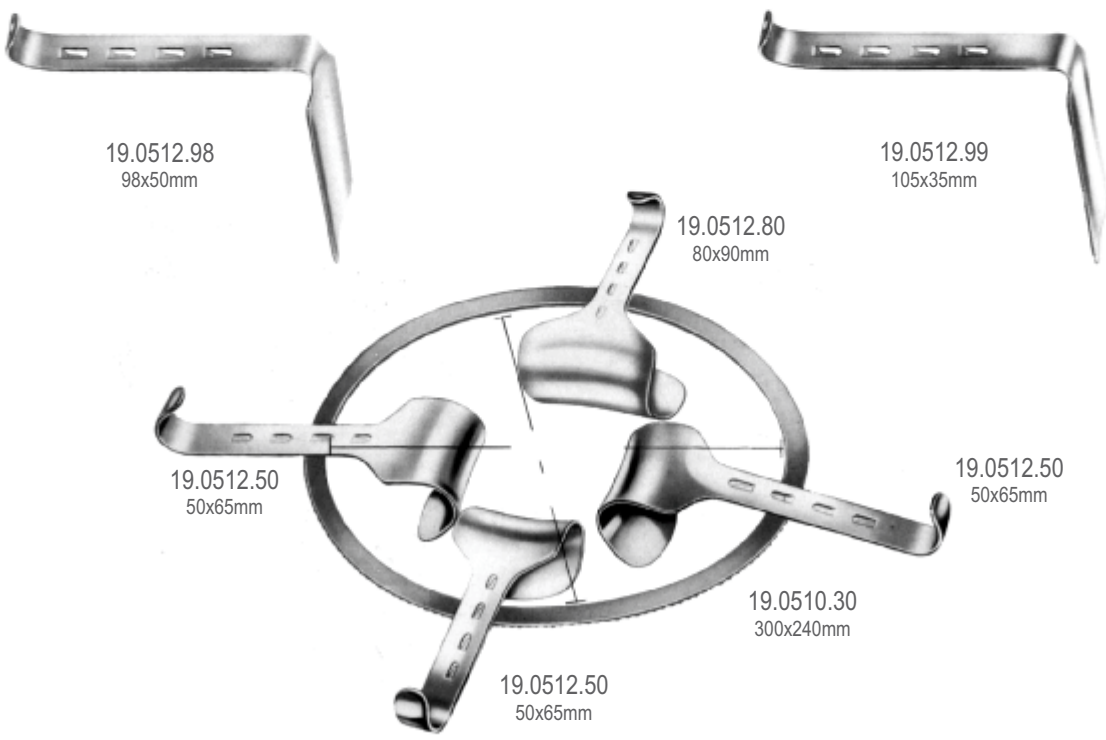
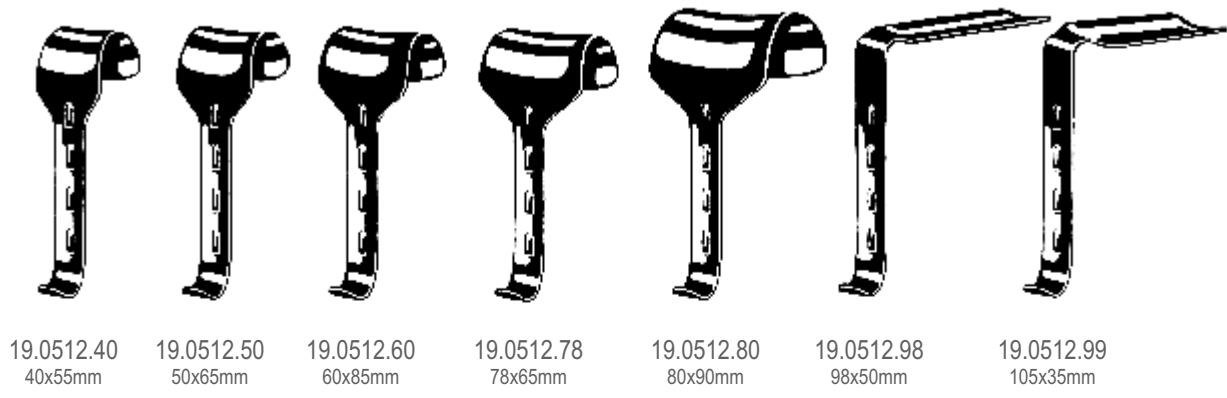

- KIRSCHNER, OVAL**
- 19.0510.00 complete
 - 19.0510.30 1 frame 300x240mm
 - 19.0512.50 3 hook-on retractors, 50x65mm
 - 19.0512.80 1 blade, 80x90mm
 - 19.0512.98 1 blade, 98x50mm
 - 19.0512.99 1 blade, 105x35mm

RETRACTORS

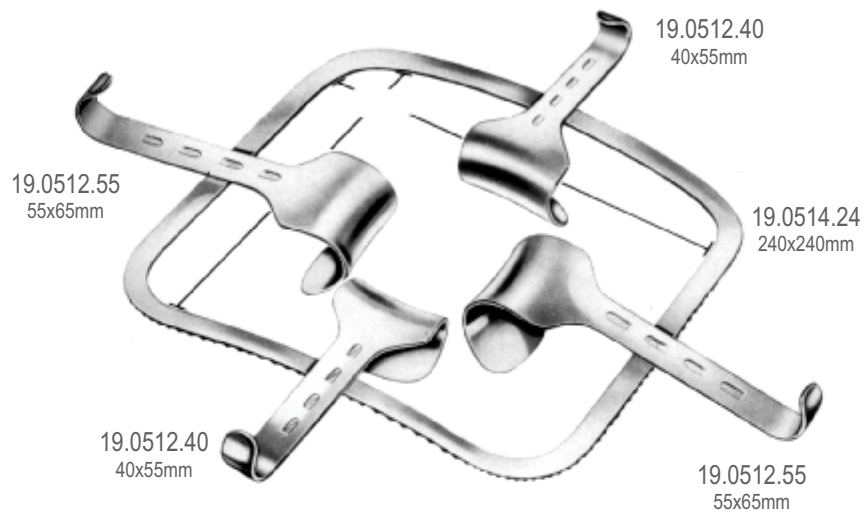

KIRCHNER

- 19.0514.00 complete
- 19.0514.24 1 frame, rigid, 240x240mm
- 19.0512.40 2 hook-on retractors, 40x55mm
- 19.0512.55 2 hook-on retractors, 55x65mm



KIRCHNER

- 19.0516.00 complete
- 19.0516.28 1 folding frame, 280x280mm
- 19.0512.40 2 blades, 40x55mm
- 19.0512.50 2 blades, 50x65mm

Abdominal Retractors
 Bauchdeckenhalter
 Separadores abdominales
 Ранорасширители абдоминальные
 腹部牽开器



FOLDING FRAME
 19.0520.30 300x300mm

19.0428.70
 38x60mm

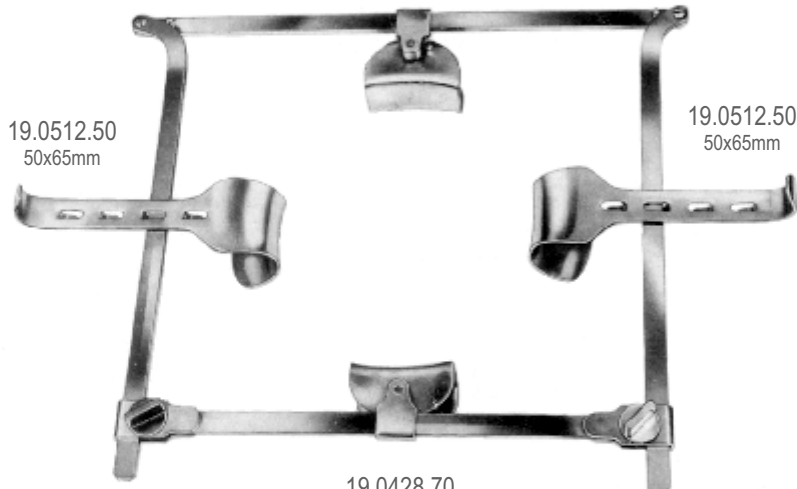

19.0512.50
 50x65mm

19.0512.50
 50x65mm

19.0428.70
 38x60mm

19.0428.90
 45x80mm



19.0512.60
 60x85mm

19.0512.60
 60x85mm

19.0428.90
 45x80mm

FRANZ

- 19.0520.00 abdominal retractor, set folding complete consisting of;
 19.0520.30 1 frame, folding 300x300mm
 19.0428.70 2 exchangeable blades 38x60mm
 19.0512.50 2 hook-on retractor 50x65mm

FRANZ

- 19.0522.00 abdominal retractor, set folding complete consisting of;
 19.0520.30 1 frame, folding 300x300mm
 19.0428.70 2 exchangeable blades 38x60mm
 19.0528.90 2 exchangeable blades 45x80mm
 19.0512.50 2 hook-on retractor 50x65mm
 19.0512.60 2 hook-on retractor 60x85mm

RETRACTORS

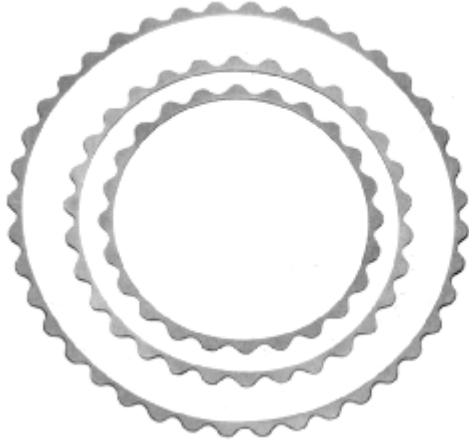

TURNER-WARWICK

19.0532.01
460x330mm

TURNER-WARWICK

19.0530.18 18.5cm
19.0530.23 23.0cm
19.0530.30 30.0cm

TURNER-WARWICK

19.0532.00 complete

RETRACTORS



19.0534.01
75x20mm

19.0534.02
100x40mm

19.0534.03
90x58mm

19.0534.04
115x58mm

19.0534.05
50x40mm



19.0534.06
75x60mm

19.0534.07
90x60mm

19.0534.08
114x60mm

19.0534.09
13mm (hook)

Abdominal Retractors
 Bauchdeckenhalter
 Separadores abdominales
 Ранорасширители абдоминальные
 腹部牵开器



ROCHARD
310mm



ROCHARD
19.0544.19

- | | | | |
|------------|----------|------------|-----------|
| 19.0540.01 | 48x90mm | 19.0540.08 | 80x155mm |
| 19.0540.02 | 48x105mm | 19.0540.09 | 100x100mm |
| 19.0540.03 | 48x120mm | 19.0540.10 | 100x105mm |
| 19.0540.04 | 48x135mm | 19.0540.11 | 100x120mm |
| 19.0540.05 | 48x155mm | 19.0540.12 | 100x155mm |
| 19.0540.06 | 80x105mm | 19.0540.13 | 150x150mm |
| 19.0540.07 | 80x120mm | | |

RETRACTORS

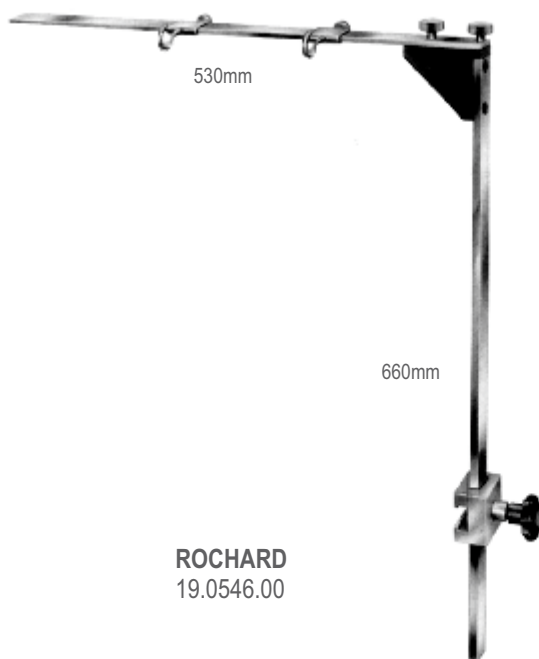

ROCHARD
19.0546.00



ROCHARD
19.0548.00



SURGICAL
INSTRUMENTS



THE ULTIMATE CHOICE

Hilton
PREMIUM STAINLESS STEEL



THE ULTIMATE CHOICE

PROBES, APPLICATORS & SPATULAS

Probes, Applicators & Spatulas
Sonden, Watterträger und Spatel
Sondas, Porta-algodones y Espátulas
ЗОНДЫ, АПЛИКАТОРЫ И ШПАТЕЛИ
探头，施用和锅铲



1mm

11.5cm	20.0010.11
12.5cm	20.0010.12
14.0cm	20.0010.14
16.0cm	20.0010.16
18.0cm	20.0010.18
20.0cm	20.0010.20
25.0cm	20.0010.25



2mm

20.0012.11
20.0012.12
20.0012.14
20.0012.16
20.0012.18
20.0012.20
20.0012.25



20.0014.11
20.0014.12
20.0014.14
20.0014.16
20.0014.18
20.0014.20
20.0014.25



20.0016.12
20.0016.14
20.0016.16
20.0016.18
20.0016.20



20.0018.12
20.0018.14
20.0018.16
20.0018.18
20.0018.20



10.5cm	20.0020.10
13.0cm	20.0020.13
14.5cm	20.0020.14
16.0cm	20.0020.16
18.0cm	20.0020.18
20.0cm	20.0020.20



11.5cm	20.0024.11
12.5cm	20.0024.12
14.0cm	20.0024.14
16.0cm	20.0024.16
18.0cm	20.0024.18
20.0cm	20.0024.20
25.0cm	20.0024.25

Silver



20.0026.11
20.0026.12
20.0026.14
20.0026.16
20.0026.18
20.0026.20
20.0026.25



FISH

20.0032.14	14.5cm
20.0032.18	18.0cm



FISH

20.0036.10	10.0cm
------------	--------

PROBES, APPLICATORS & SPATULAS



11.5cm 20.0040.11
12.5cm 20.0040.12
14.0cm 20.0040.14
16.0cm 20.0040.16
18.0cm 20.0040.18
20.0cm 20.0040.20



20.0042.11
20.0042.12
20.0042.14
20.0042.16
20.0042.18
20.0042.20



DOYEN
20.0050.14
14.0cm



NELATON
20.0054.16
16.0cm



20.0056.12
12.0cm



KRONECKER
20.0060.13 13.0cm



JOHNS-HOPKINS
20.0064.15 15.0cm



ROSER
20.0068.12 12.5cm



SYME
20.0072.17 17.0cm



20.0076.14 14.0cm
20.0076.17 17.0cm

Elevators and Plaster Spatula
 Elevatoorien und Pflasterspatel
 Elevadores y espátulas
 Шпатели для гипса
 电梯和石膏刮刀



PROBES, APPLICATORS & SPATULAS



20.0080.13 13.0cm
 20.0080.14 14.5cm



20.0084.17 17.5cm



MCDONALD
 20.0090.19 19.0cm



KILLIAN
 20.0092.19 19.0cm



WATSON CHEYENE
 20.0096.13 13.0cm
 20.0096.19 19.0cm



WATSON CHEYENE
 20.0100.17 17.5cm



PLAYFAIR
 20.0104.31 31.0cm



CHEYENE
 20.0108.12 12.5cm
 20.0108.17 17.5cm



Cotton Applicators
 Wattertrager
 Pora-algodones
 Зонды для тампонов
 卷棉子

PROBES, APPLICATORS & SPATULAS

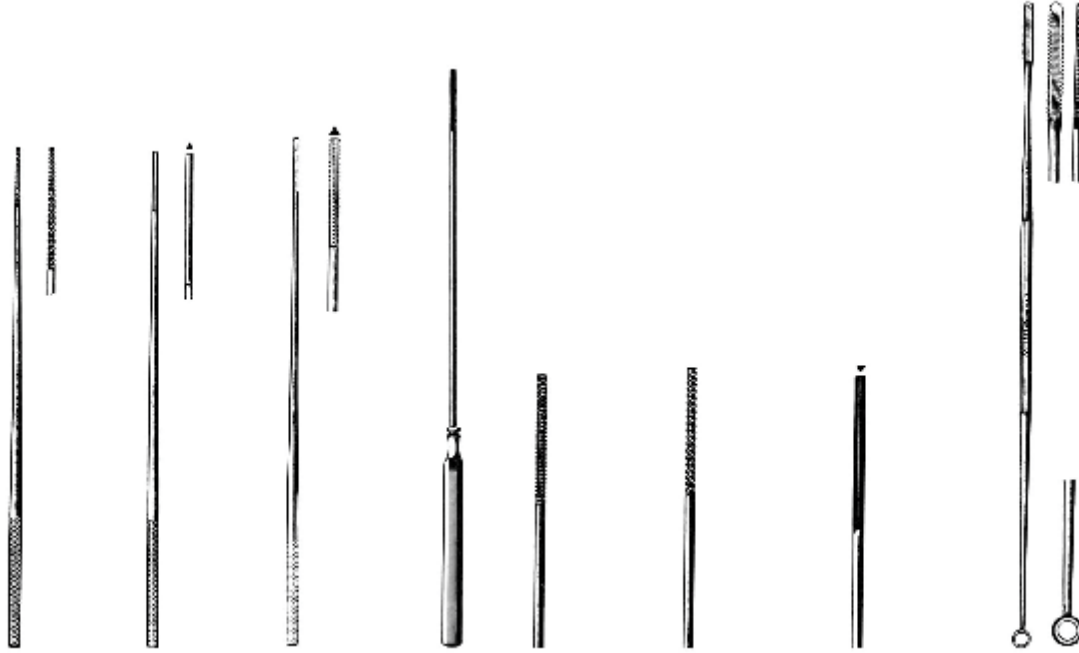

	FARREL						JOBSON-HORNE	
12.0cm	20.0110.12	20.0112.12	20.0114.12	20.0120.12	20.0122.12	20.0124.12	20.0130.12	12.5cm
14.0cm	20.0110.14	20.0112.14	20.0114.14	20.0120.14	20.0122.14	20.0124.14	20.0130.18	18.0cm
16.0cm	20.0110.16	20.0112.16	20.0114.16	20.0120.16	20.0122.16	20.0124.16		
18.0cm	20.0110.18	20.0112.18	20.0114.18	20.0120.18	20.0122.18	20.0124.18		
23.0cm	20.0110.23	20.0112.23	20.0114.23					

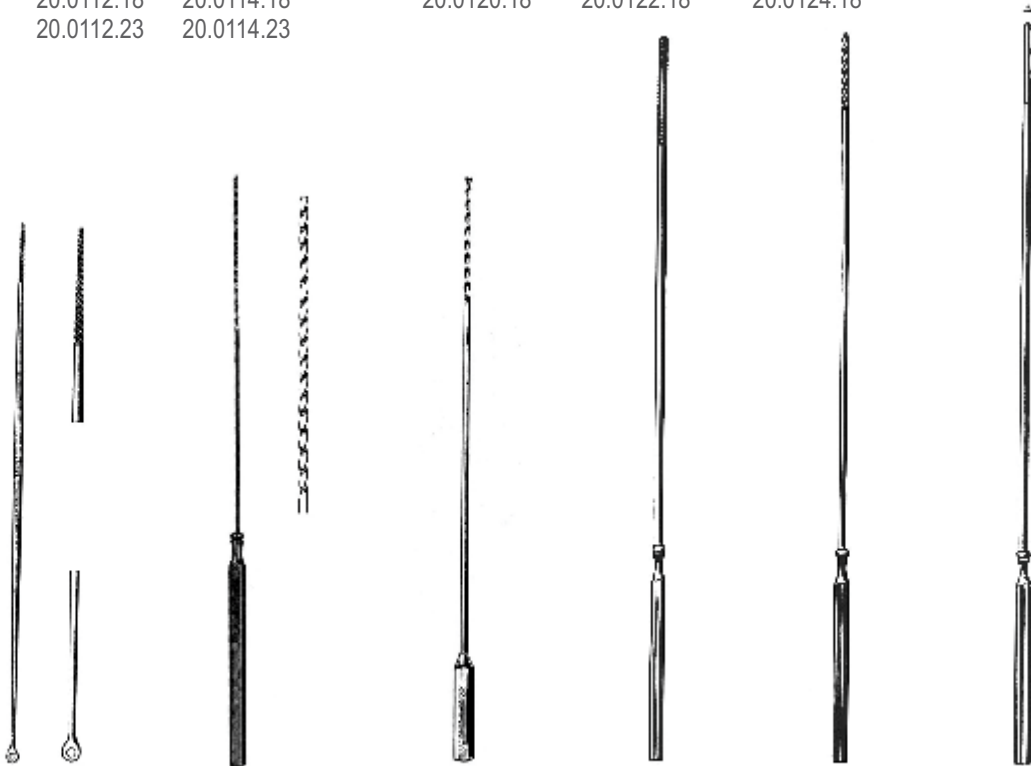

JOBSON-HORNE						
20.0136.15	20.0140.16	20.0144.25	20.0148.28	20.0150.28	20.0152.28	
15.0cm	16.0cm	25.0cm	28.0cm	28.0cm	28.0cm	

Sponge Holder
Schwammhalter
Porta-esponjas
Зонды для тампонов
海绵支架

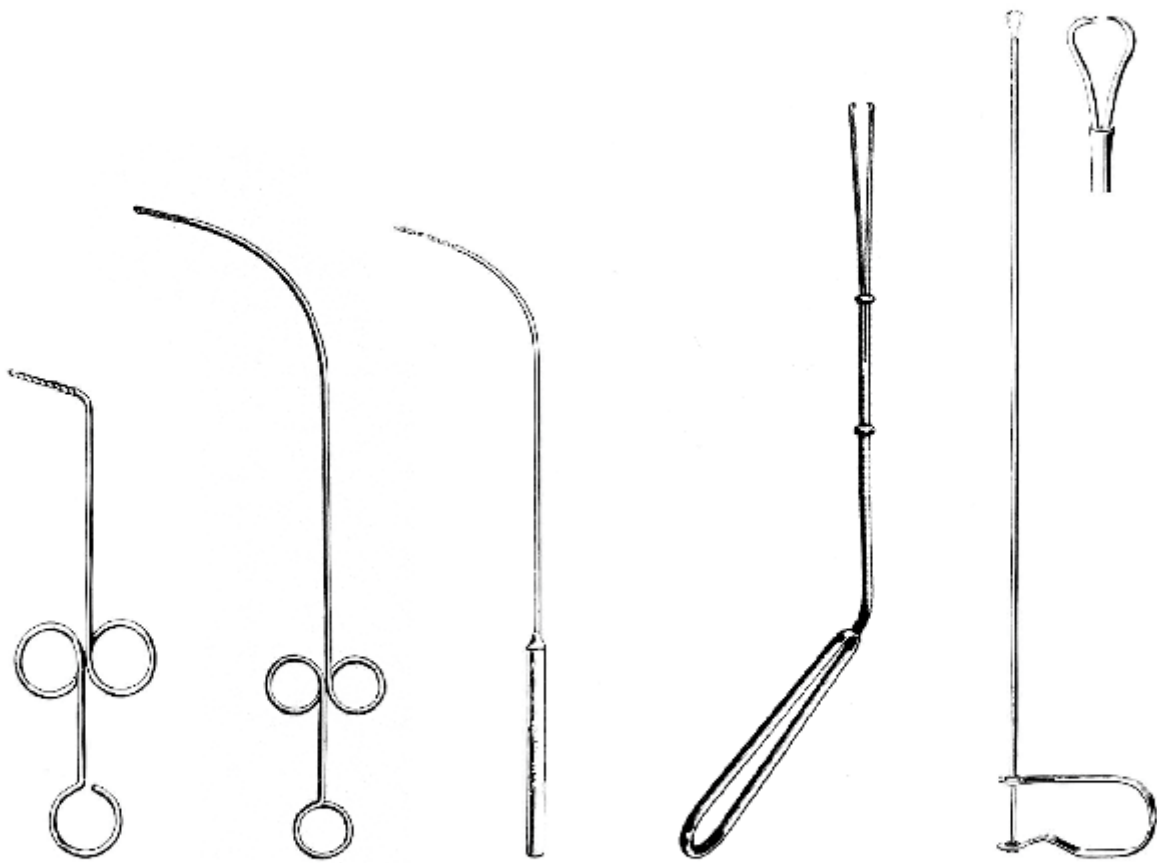

HARTMANN
20.0160.20 20.0cm

FEIN
20.0162.28 28.0cm

TOBOLD
20.0166.25 25.0cm

20.0170.40 40.0cm

20.0176.45 45.0cm

PROBES, APPLICATORS & SPATULAS

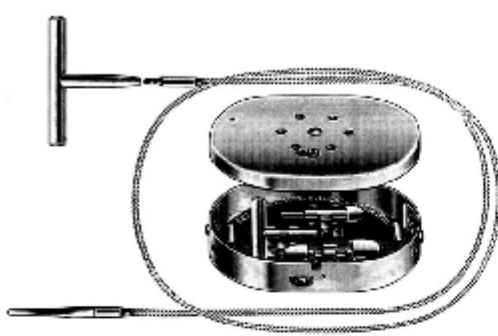

NABATOFF
 20.0180.00
 complete set.
 135 x 100 x 25mm

20.0180.01

20.0180.02



20.0180.04



20.0180.03
 3.0mm Ø



20.0180.06
 6.0mm Ø



20.0180.09
 9.0mm Ø



20.0180.12
 12.0mm Ø

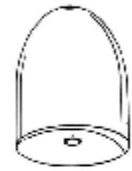

20.0180.15
 15.0mm Ø



20.0190.12 12.0cm



50.0cm

20.0194.02
 2.0mm Ø

20.0194.03
 3.0mm Ø

20.0194.04
 4.0mm Ø

20.0194.06
 6.0mm Ø

20.0194.07
 7.0mm Ø

20.0194.08
 8.5mm Ø

20.0194.10
 10.0mm Ø

20.0194.12
 12.0mm Ø

20.0194.14
 14.0mm Ø



SURGICAL
INSTRUMENTS



THE ULTIMATE CHOICE

Hilton
PREMIUM STAINLESS STEEL



THE ULTIMATE CHOICE

SUTURE

Suture

Naht

Sutura

ШОВНЫЙ ИНСТРУМЕНТ

缝合

22

001 - 016



DERF
 22.0010.12 12.0cm

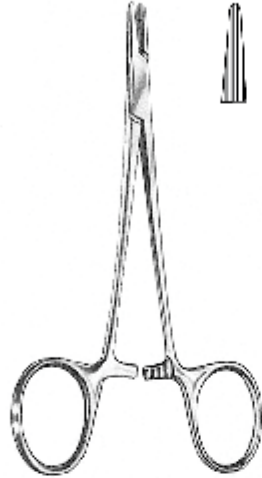

DERF
 22.0012.12 12.5cm

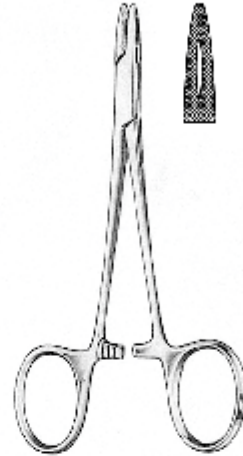

COLLIER
 22.0020.12 12.5cm

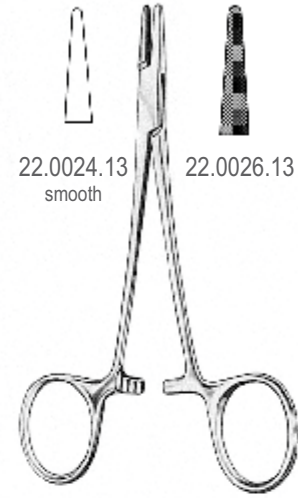

WEBSTER
 13.0cm

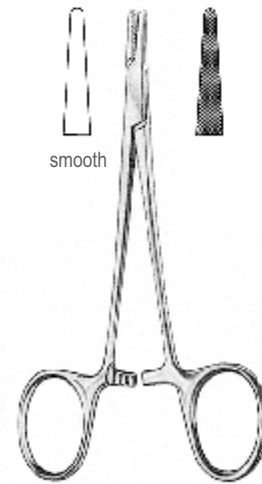

HALSEY
 22.0030.13 13.0cm 22.0032.13



NEIVERT
 22.0036.13 13.0cm



HEGAR-BAUMGARTNER
 22.0040.12 12.5cm
 22.0040.14 14.0cm

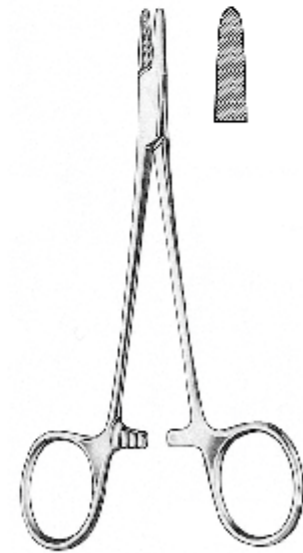

BROWN
 22.0046.13 13.0cm
 22.0046.18 18.0cm

SUTURE

Needle Holders
Nadelhalter
Porta-agujas
Иглодержатели стандартные
持针钳

SUTURE



MAYO-HEGAR

22.0050.14	14.0cm	22.0051.14
22.0050.15	15.0cm	22.0051.15
22.0050.16	16.0cm	22.0051.16
22.0050.18	18.0cm	22.0051.18
22.0050.20	20.0cm	22.0051.20
22.0050.22	22.0cm	22.0051.22
22.0050.24	24.0cm	22.0051.24
22.0050.26	26.0cm	22.0051.26
22.0050.28	28.0cm	22.0051.28
22.0050.30	30.0cm	22.0051.30

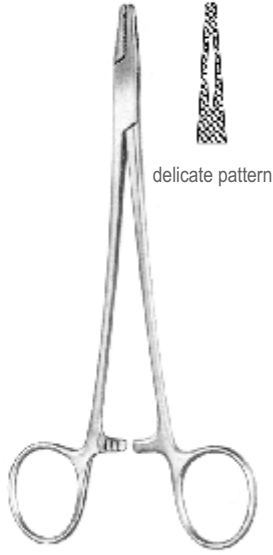

delicate pattern

MAYO-HEGAR

22.0056.16	16.0cm
22.0056.18	18.0cm
22.0056.20	20.0cm



CRILE-MURRAY

22.0060.15	15.0cm
------------	--------



CRILE-WOOD

22.0066.15	15.0cm
22.0066.18	18.0cm
22.0066.20	20.0cm

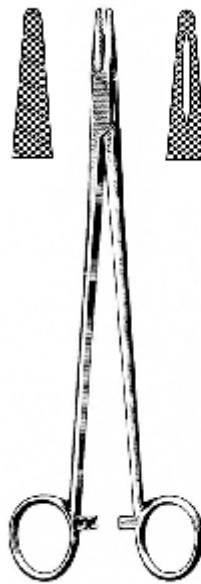

HEGAR

22.0070.20	20.0cm	22.0072.20
22.0070.24	24.0cm	22.0072.24



ADSON

22.0076.18	18.0cm
------------	--------

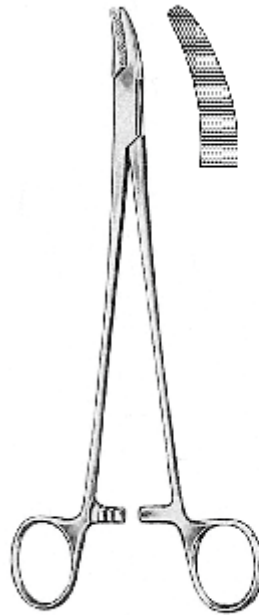

HEANEY

22.0080.21	21.0cm
------------	--------



METZENBAUM

22.0086.18	18.0cm
------------	--------

Needle Holders
 Nadelhalter
 Porta-agujas
 Иглодержатели стандартные
 持针钳



MASSON-LUETHY
 22.0090.26 26.0cm

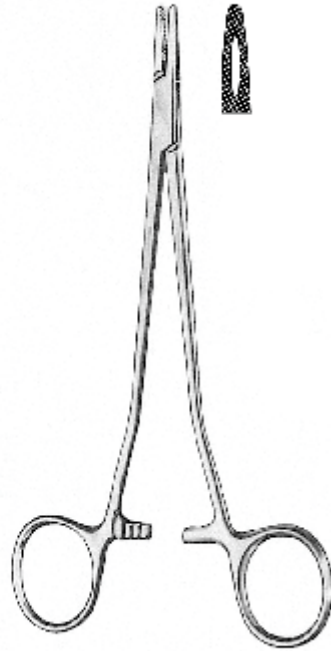

SAROT
 22.0096.18 18.0cm
 22.0096.26 26.0cm

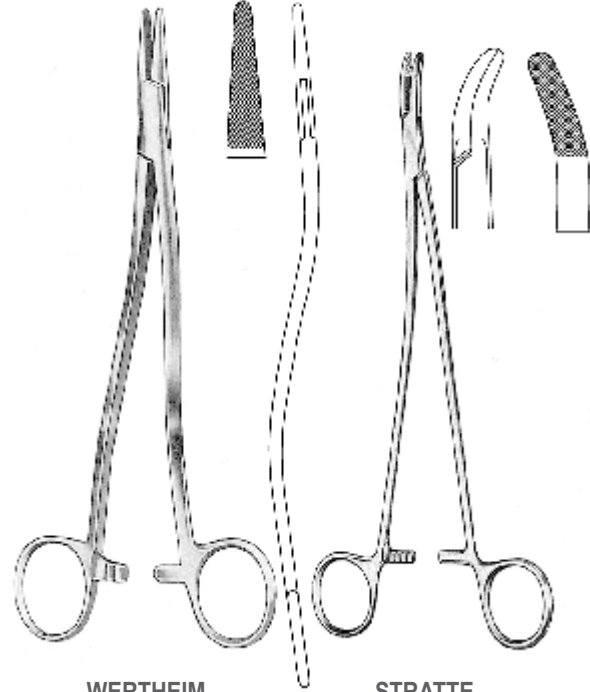

WERTHEIM
 22.0100.20 20.0cm
 22.0100.24 24.0cm

STRATTE
 22.0106.23 23.0cm

SUTURE



BRUCE-CLARKE
 22.0110.12 12.5cm

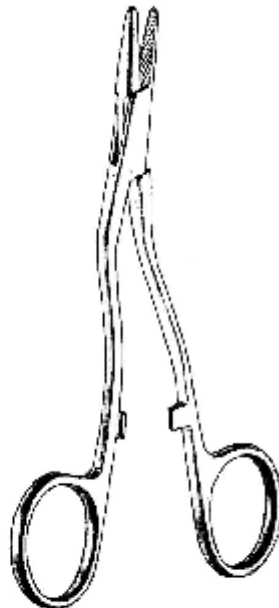

KILNER
 22.0116.13 13.5cm
 22.0116.16 16.5cm



THOMSON-WALKER
 22.0120.20 20.0cm

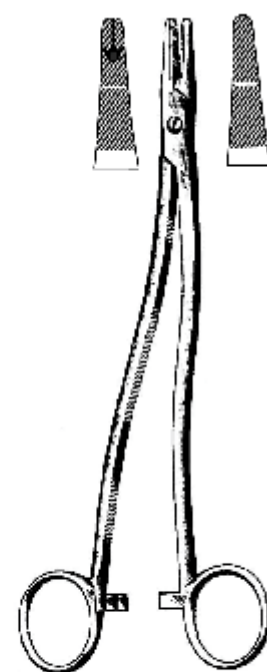

BOZEMANN
 22.0126.20 20.0cm
 22.0126.24 24.0cm

SUTURE



JOHNSON
22.0130.27 27.0cm

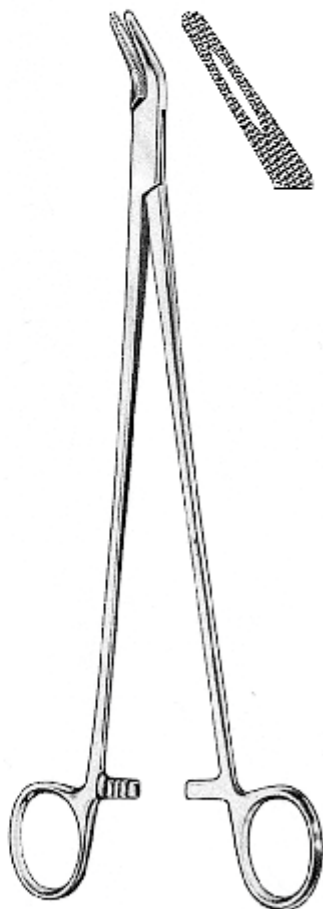

FINOCCHIETTO
22.0136.18 18.0cm
22.0136.20 20.0cm
22.0136.27 27.0cm

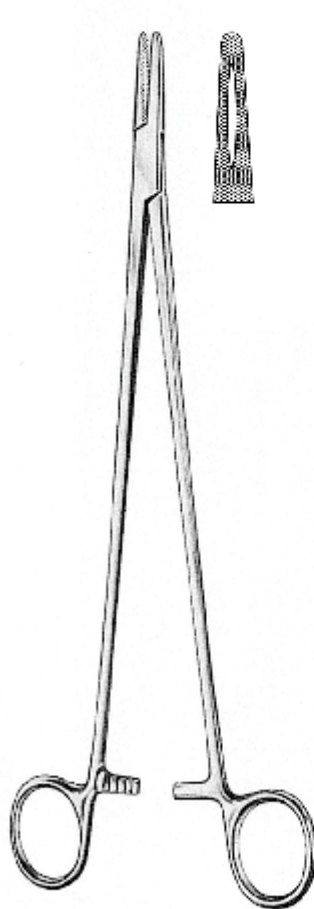

MASSON
22.0140.27 27.0cm

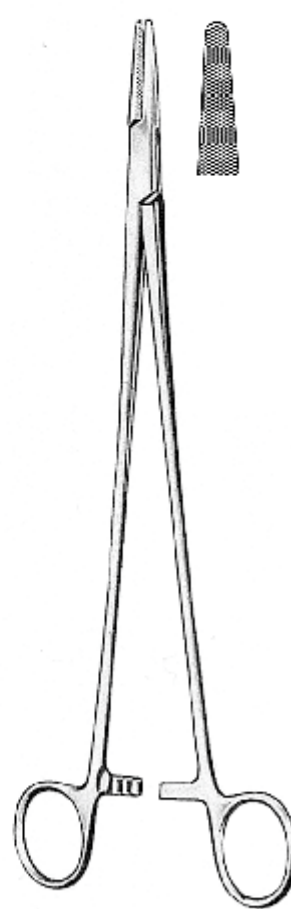

WANGENSTEEN
22.0144.27 27.0cm

Needle Holders
 Nadelhalter
 Porta-agujas
 Иглодержатели стандартные
 持针钳

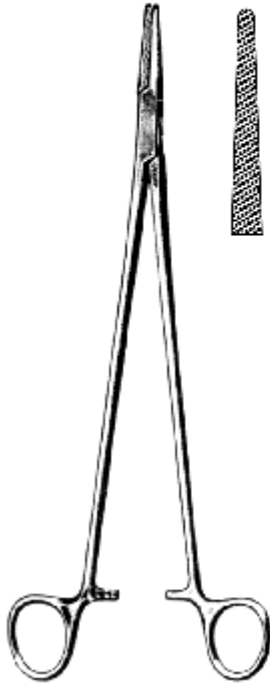

WANGENSTEEN
 22.0146.27 27.0cm

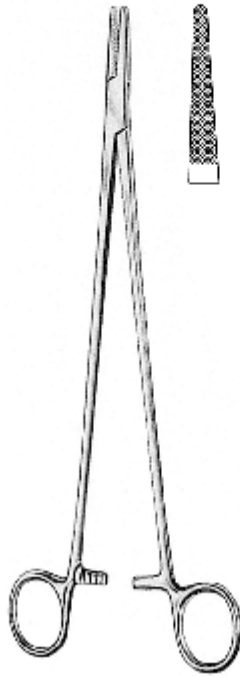

JAMISON
 22.0150.23 23.5cm

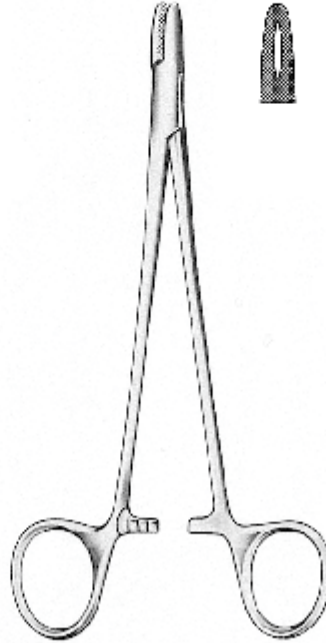

M.G.H.(mass-general-hospital)
 22.0156.17 17.0cm

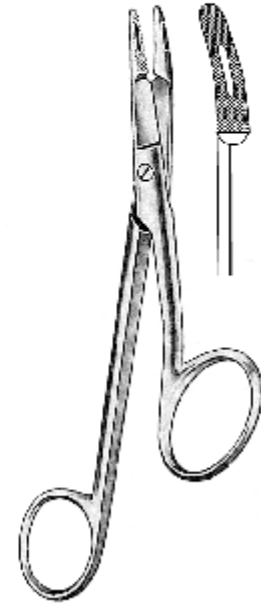

GILLIES
 22.0160.16 16.0cm
 22.0161.16 16.0cm (left hand)

SUTURE

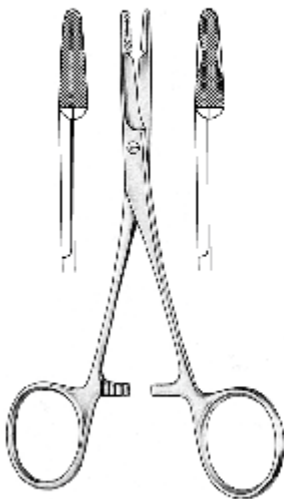

OLSEN-HEGAR
 22.0170.14 14.0cm 22.0171.14
 with blood groove

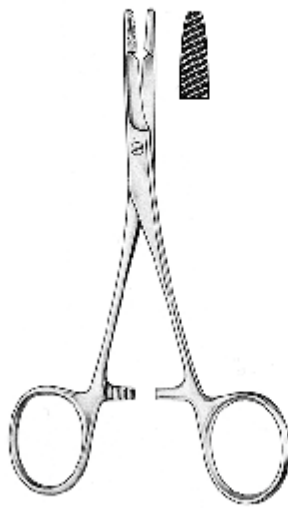

OLSEN-HEGAR
 22.0172.17 17.0cm

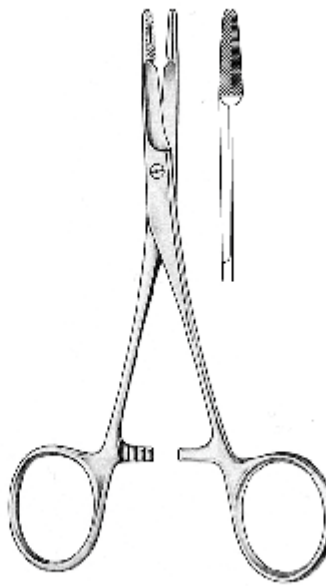

OLSEN-HEGAR
 22.0174.17 17.0cm

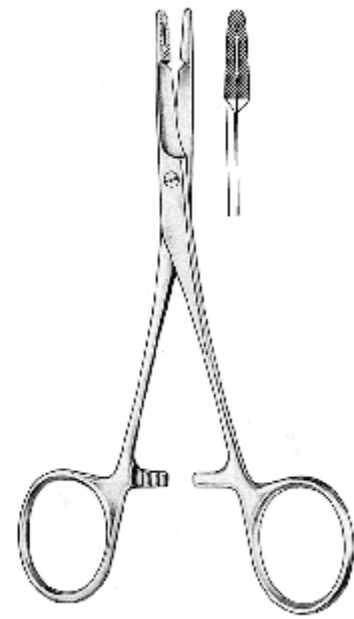

OLSEN-HEGAR
 22.0176.14 14.0cm
 22.0176.18 18.0cm



CRILE
22.0180.15 15.0cm



TOENNIS
22.0186.18 18.0cm

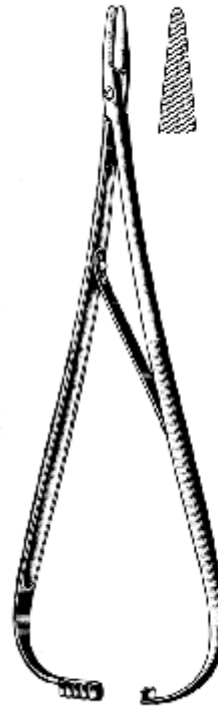

LICHTENBERG
22.0190.20 20.0cm

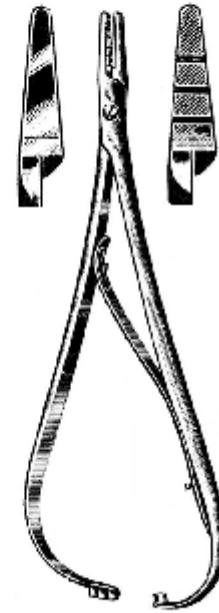

MACPHAIL(copper jaw)
22.0196.14 14.0cm
22.0196.16 16.0cm
22.0196.18 18.0cm
22.0196.20 20.0cm

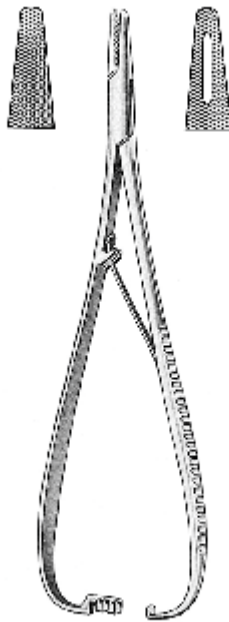

MATHIEU
22.0200.14 14.0cm 22.0202.14
22.0200.17 17.0cm 22.0202.17
22.0200.20 20.0cm 22.0202.20
22.0200.24 24.0cm 22.0202.24



MATHIEU
22.0204.14 14.0cm
22.0204.17 17.0cm



MATHIEU
22.0206.17 17.0cm
22.0206.20 20.0cm



BARRAQUER
 22.0210.16
 16.0cm

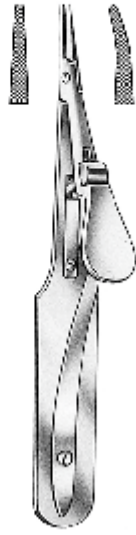

ARRUGA
 22.0214.14 14.0cm
 22.0215.14 14.0cm



KALT
 22.0220.14
 14.0cm

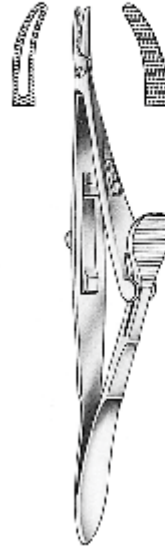

KALT-ARRUGA
 22.0224.14
 14.0cm

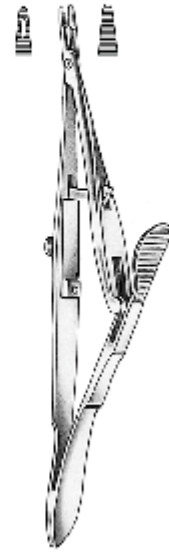

CASTROVIEJO-KALT
 22.0226.13
 13.5cm



BOYNTON
 22.0230.12
 12.0cm



ARRUGA
 22.0234.16 16.0cm
 22.0235.16 16.0cm



STEVENSON
 22.0240.11
 11.0cm



STEVENS
 22.0246.13 13.0cm
 22.0246.15 15.0cm



WECKER
 22.0250.15
 15.0cm



BARRAQUER
 22.0256.14
 14.0cm

SUTURE

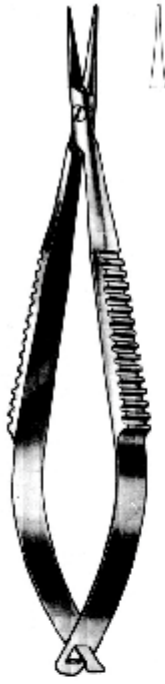

CASTROVIEJO
22.0260.09 9.0cm

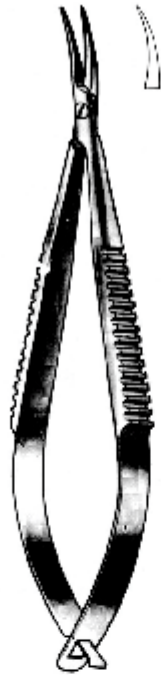

CASTROVIEJO
22.0261.09 9.0cm



CASTROVIEJO
22.0262.09 9.0cm



CASTROVIEJO
22.0263.09 9.0cm

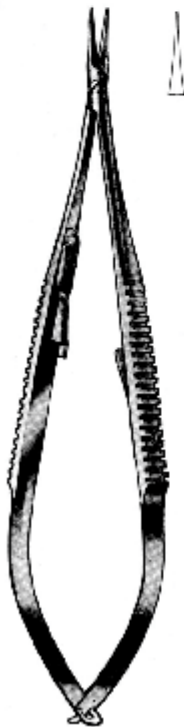

CASTROVIEJO
22.0262.14 14.0cm

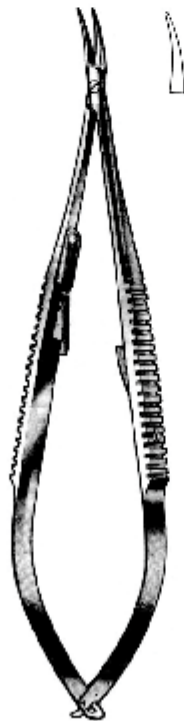

CASTROVIEJO
22.0263.14 14.0cm

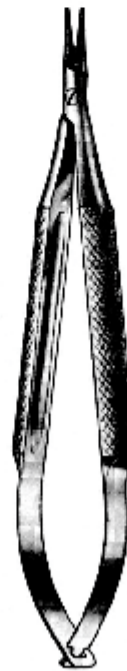

BARRAQUER
22.0266.10 10.0cm

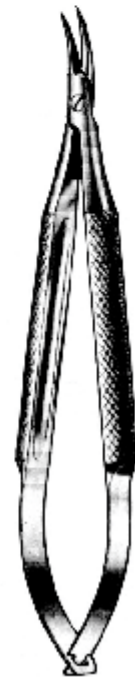

BARRAQUER
22.0267.10 10.0cm

Micro-Needle Holders
 Mikro-Nadelhalter
 Micro-porta-agujas
 Микроиглодержатели стандартные
 微针钳



BARRAQUER-TROUTMAN
 22.0270.10 10.0cm



BARRAQUER-TROUTMAN
 22.0271.10 10.0cm

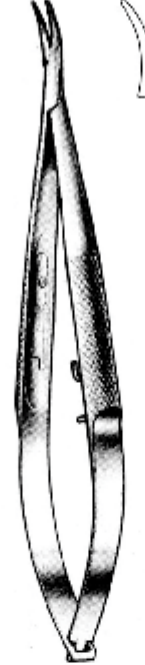

BARRAQUER
 22.0276.14 14.0cm

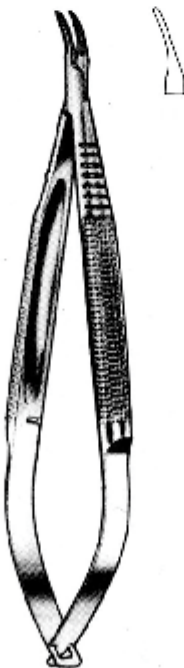

BARRAQUER
 22.0277.13 13.0cm

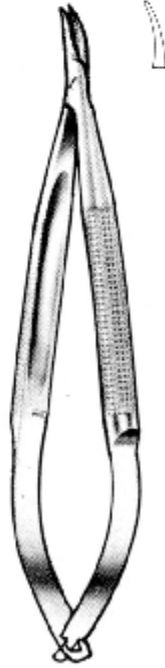

BARRAQUER
 22.0280.11 11.0cm

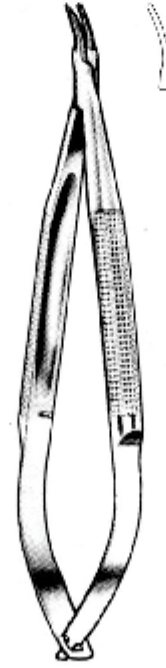

BARRAQUER
 22.0282.13 13.0cm

SUTURE



CASTROVIEJO
22.0300.14 14.0cm
22.0300.17 17.0cm

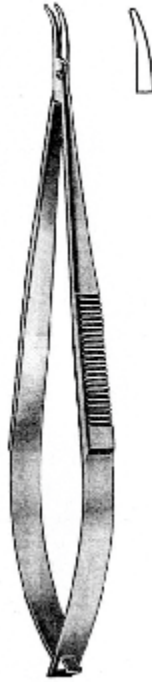

CASTROVIEJO
22.0301.14 14.0cm
22.0301.17 17.0cm



CASTROVIEJO
22.0304.14 14.0cm
22.0304.17 17.0cm

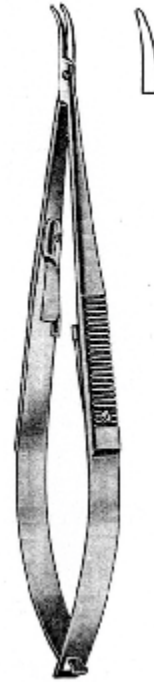

CASTROVIEJO
22.0305.14 14.0cm
22.0305.17 17.0cm



JACOBSON
22.0310.18 18.5cm
22.0310.21 21.0cm



JACOBSON
22.0314.18 18.5cm
22.0314.21 21.0cm

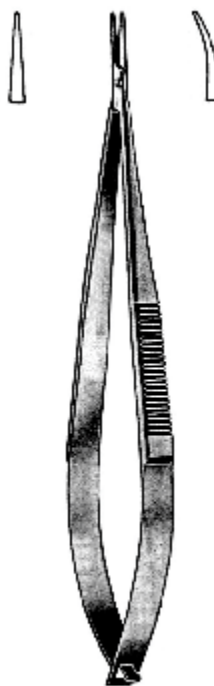

CASTROVIEJO
22.0320.10 10.0cm
22.0321.10 10.0cm

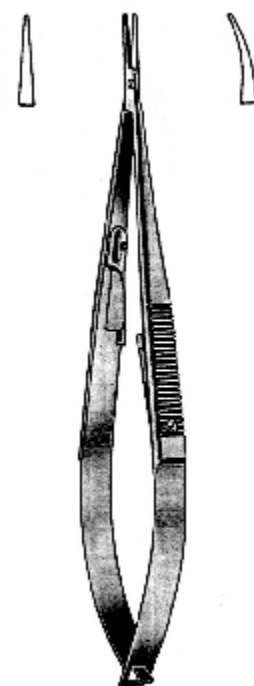

CASTROVIEJO
22.0324.10 10.0cm
22.0325.10 10.0cm

Micro-Needle Holders
 Mikro-Nadelhalter
 Micro-porta-agujas
 Микроиглодержатели стандартные
 微针钳



22.0330.16 16.0cm



22.0336.01 23.0cm Fig.1
 22.0336.02 23.0cm Fig.2
 22.0336.03 19.0cm Fig.3

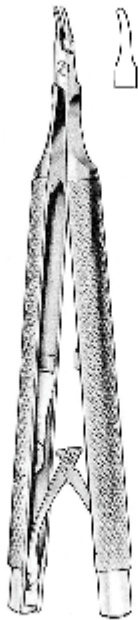

CASTROVIEJO-BARRAQUER
 22.0340.12 12.0cm

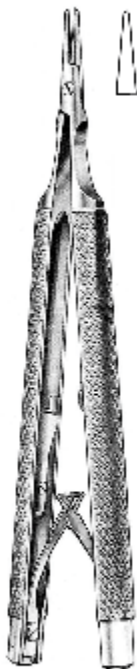

CASTROVIEJO
 22.0342.13 13.0cm

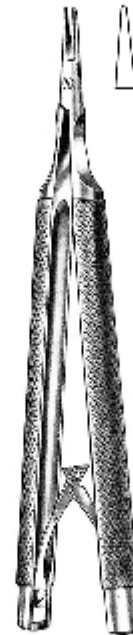

CASTROVIEJO
 22.0344.12 12.0cm

SUTURE



REVERDIN
14.0cm



Fig.1
22.0350.01



Fig.2
22.0350.02



Fig.3
22.0350.03



Fig.4
22.0350.04



REVERDIN
19.0cm
21.0cm



REVERDIN
23.0cm



Fig.1
22.0352.01
22.0354.01
22.0356.01



Fig.2
22.0352.02
22.0354.02
22.0356.02



Fig.3
22.0352.03
22.0354.03
22.0356.03



Fig.4
22.0352.04
22.0354.04
22.0356.04

Ligature Needles
 Unterbindungsnadeln
 Agujas para ligaduras
 Иглы лигатурные
 结扎针



sharp

22.0360.20 20.0cm
 22.0362.20 20.0cm



blunt

22.0364.20 20.0cm
 22.0366.20 20.0cm

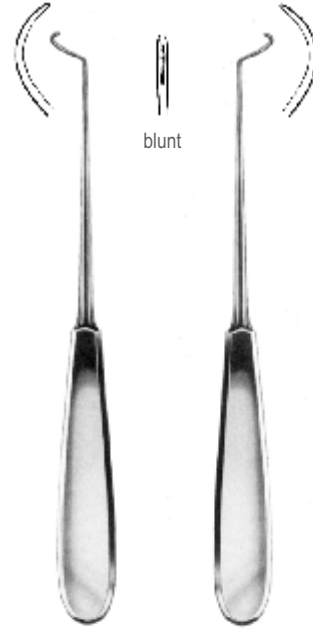

blunt

22.0368.20 20.0cm
 22.0370.20 20.0cm

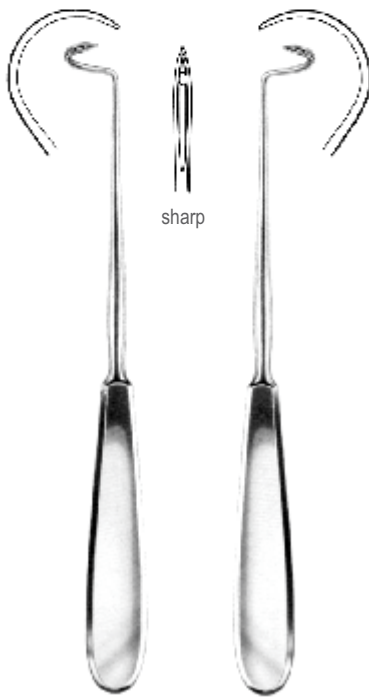

sharp

DESCHAMPS
 22.0372.21 21.0cm
 22.0374.21 21.0cm

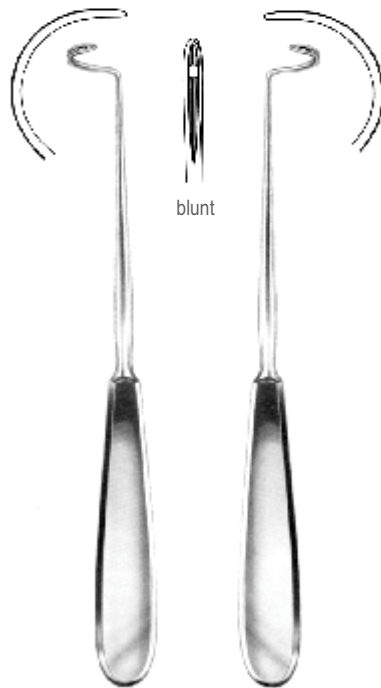

blunt

DESCHAMPS
 22.0376.21 21.0cm
 22.0378.21 21.0cm

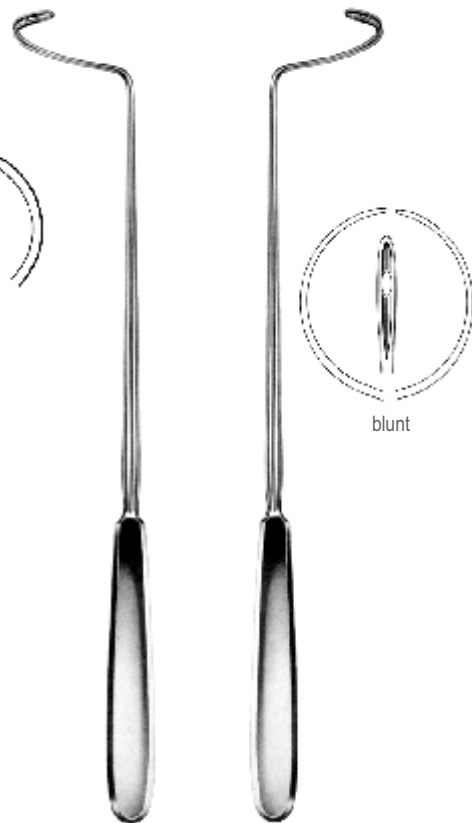

blunt

DESCHAMPS
 22.0380.28 28.0cm
 22.0382.28 28.0cm

SUTURE

SUTURE



SCHMIEDEN-DICK
22.0390.32
32.0cm



SCHMIEDEN
22.0394.21
21.0cm



22.0396.20
20.0cm



COOPER
22.0400.19
19.0cm



22.0406.23
23.0cm



YOUNG
22.0410.25 25.0cm
with 3 needles.



22.0410.01



22.0410.02



22.0410.03

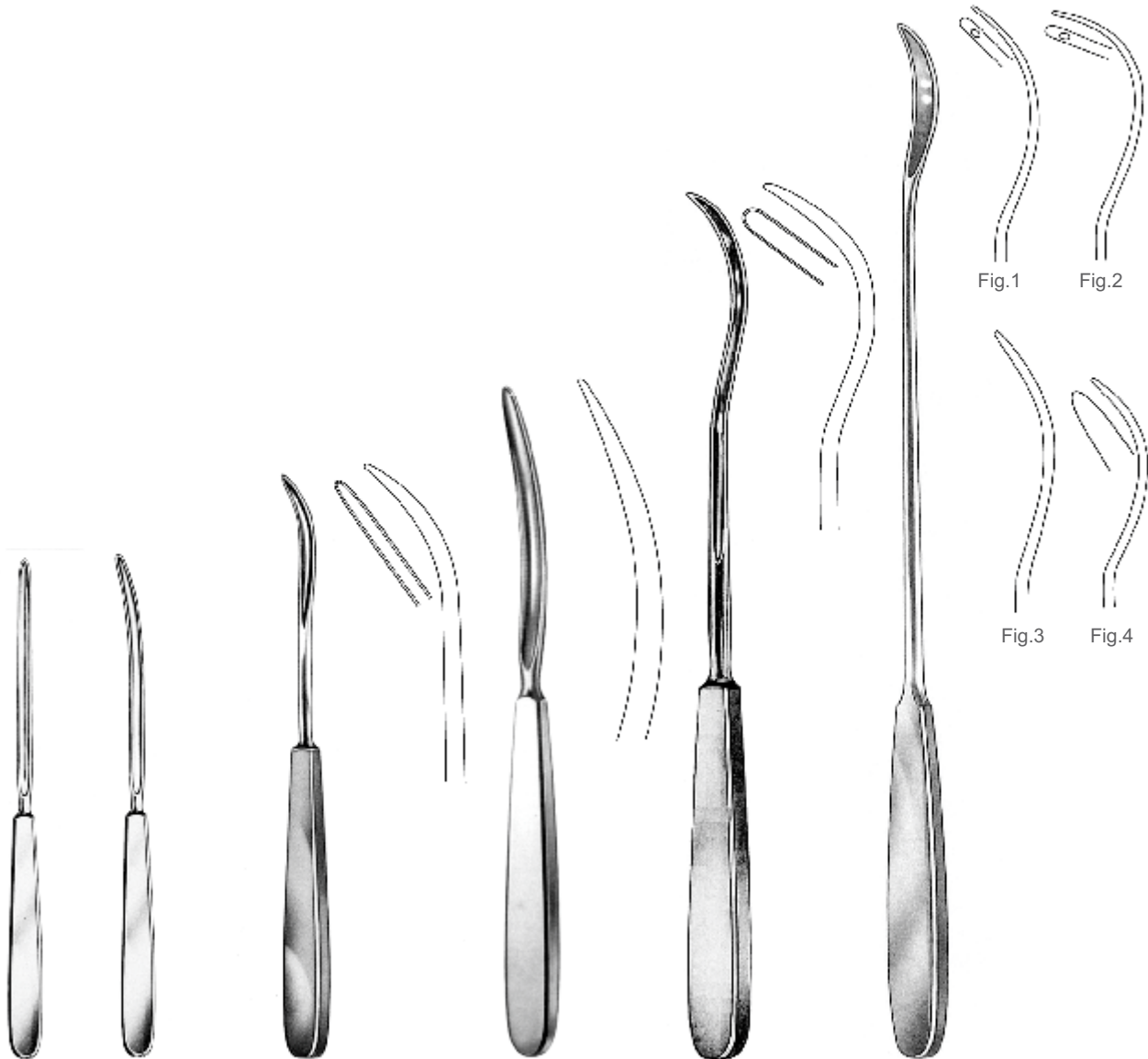

PAYR
 22.0cm
 22.0420.22
 22.0422.22

KÖNIG
 22.0426.03 19.5cm
 22.0426.05 19.5cm
 22.0426.07 20.0cm

22.0430.19
 19.0cm

KIRSCHNER
 22.0434.25
 25.0cm

BRUNNER
 30.0cm
 22.0436.01 Fig.1
 22.0436.02 Fig.2
 22.0436.03 Fig.3
 22.0436.04 Fig.4

SUTURE

SUTURE



MICHEL
22.0440.12
12.0cm



MICHEL
22.0442.12
12.0cm



WACHENFELDT
22.0444.12
12.5cm



WACHENFELDT
22.0446.12
12.0cm



WACHENFELDT
22.0448.12
12.5cm



HEGENBARTH
22.0450.12
12.5cm



CHILDE
22.0454.18
18.0cm

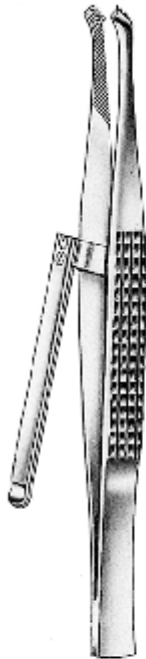

CHILDE
22.0456.18
18.0cm



MICHEL
22.0460.12
12.5cm

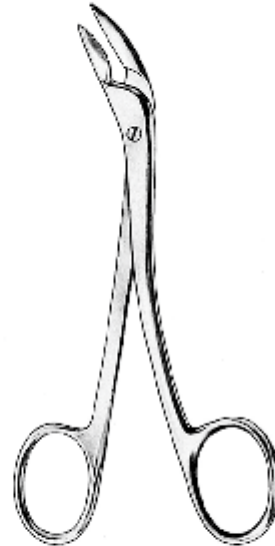

RICHTER-HEATH
22.0464.14
14.0cm



COLLIN
22.0466.13
13.0cm



SURGICAL
INSTRUMENTS



THE ULTIMATE CHOICE

Hilton
PREMIUM STAINLESS STEEL



THE ULTIMATE CHOICE

CARDIOVASCULAR

Cardiovascular Surgery
Herz-und Gefäßchirurgie
Cirugia cardiovascular
СЕРДЕЧНО-СОСУДИСТАЯ ХИРУРГИЯ
心血管

Atrauma Tissue Forceps
 Atrauma Pinzetten
 Pinzas de diseccion atrauma
 Пинцеты с атравматической нарезкой
 非创伤性组织钳

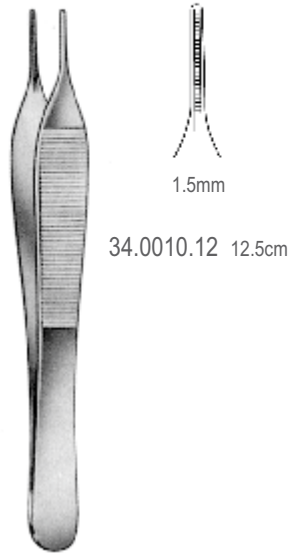

34.0010.12 12.5cm

DEBAKEY-ADSON

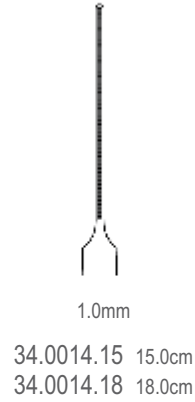

34.0014.15 15.0cm
 34.0014.18 18.0cm

DEBAKEY-GERALD



34.0016.15 15.0cm
 34.0016.18 18.0cm
 34.0016.24 24.0cm

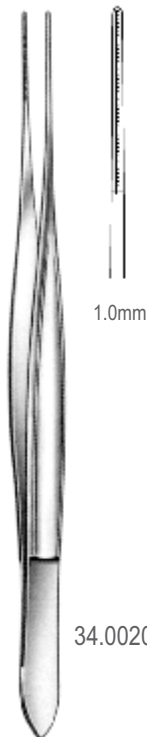

34.0020.18 18.0cm

DEBAKEY-CUSHING



34.0024.15 15.0cm 34.0026.15
 34.0024.19 19.0cm 34.0026.19
 34.0024.24 24.0cm 34.0026.24

DEBAKEY-DIETRICH



34.0030.15 15.0cm
 34.0030.19 19.0cm
 34.0030.24 24.0cm

DEBAKEY-LIGHT

CARDIOVASCULAR

ALSO AVAILABLE IN TITANIUM

CARDIOVASCULAR

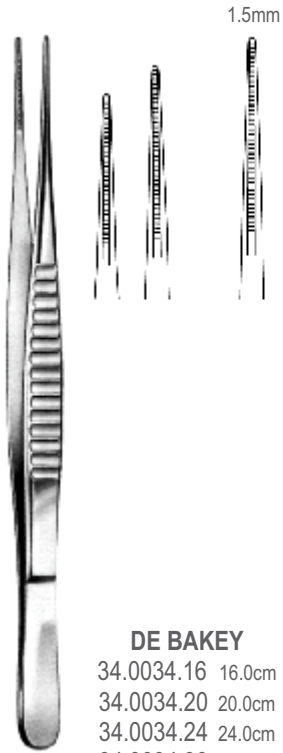

DE BAKEY
34.0034.16 16.0cm
34.0034.20 20.0cm
34.0034.24 24.0cm
34.0034.30 30.0cm

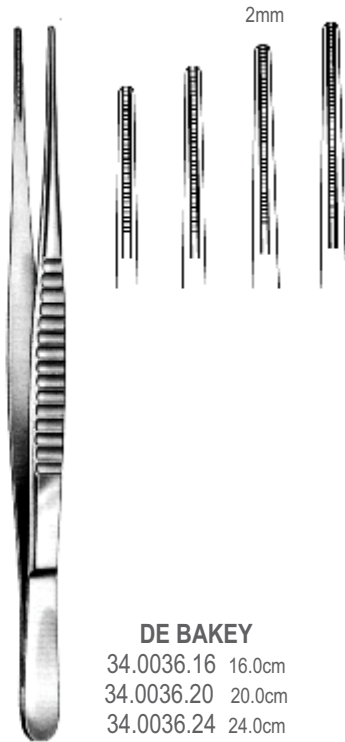

DE BAKEY
34.0036.16 16.0cm
34.0036.20 20.0cm
34.0036.24 24.0cm
34.0036.30 30.0cm

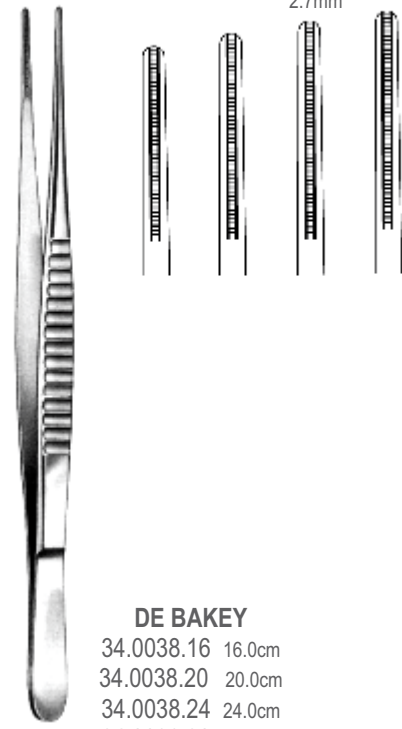

DE BAKEY
34.0038.16 16.0cm
34.0038.20 20.0cm
34.0038.24 24.0cm
34.0038.30 30.0cm

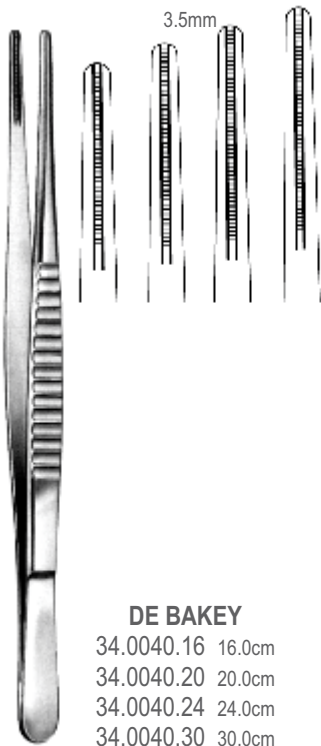

DE BAKEY
34.0040.16 16.0cm
34.0040.20 20.0cm
34.0040.24 24.0cm
34.0040.30 30.0cm

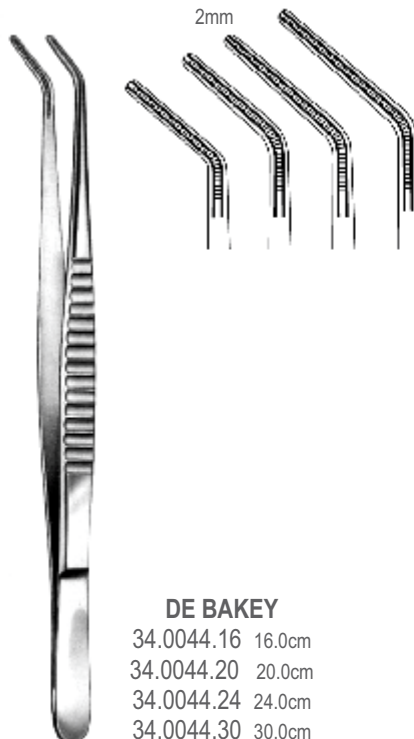

DE BAKEY
34.0044.16 16.0cm
34.0044.20 20.0cm
34.0044.24 24.0cm
34.0044.30 30.0cm



DE BAKEY
34.0046.16 16.0cm
34.0046.20 20.0cm
34.0046.24 24.0cm
34.0046.30 30.0cm

Atrauma Bulldog Clamps
 Atrauma Bulldogklemmen
 Atrauma clamps bulldog
 Зажимы типа бульдог
 非创伤性斗牛犬夹



ALSO AVAILABLE IN TITANIUM

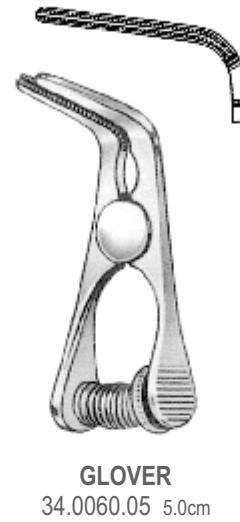

CARDIOVASCULAR

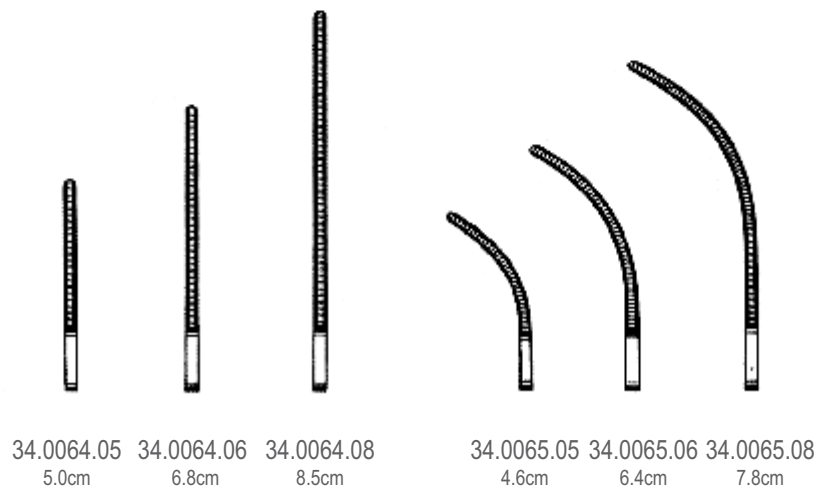

ALSO AVAILABLE IN TITANIUM

CARDIOVASCULAR



GLOVER



34.0070.07
7.0cm



34.0070.08
8.0cm



34.0070.09
9.0cm



34.0070.11
11.0cm



GLOVER



34.0071.06
6.0cm



34.0071.07
7.5cm



34.0071.08
8.5cm

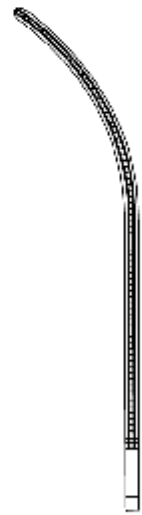

34.0071.11
10.5cm

Atrauma Bulldog Clamps
 Atrauma Bulldogklemmen
 Atrauma clamps bulldog
 Зажимы типа бульдог
 非创伤性斗牛犬夹



ALSO AVAILABLE IN TITANIUM



DE BAKEY

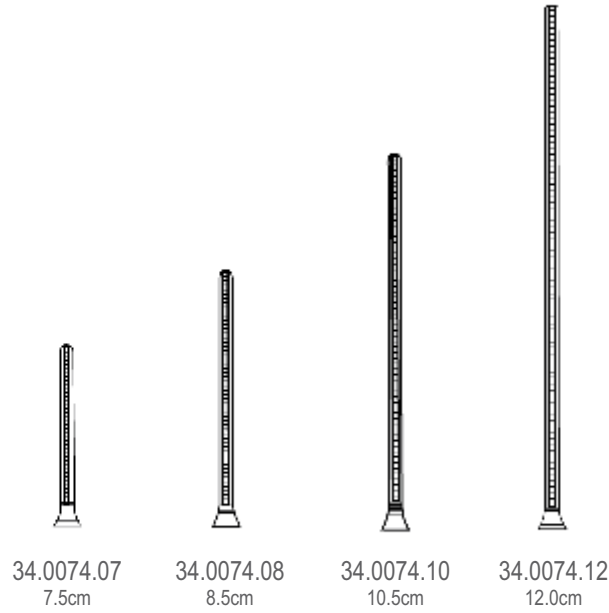

DE BAKEY

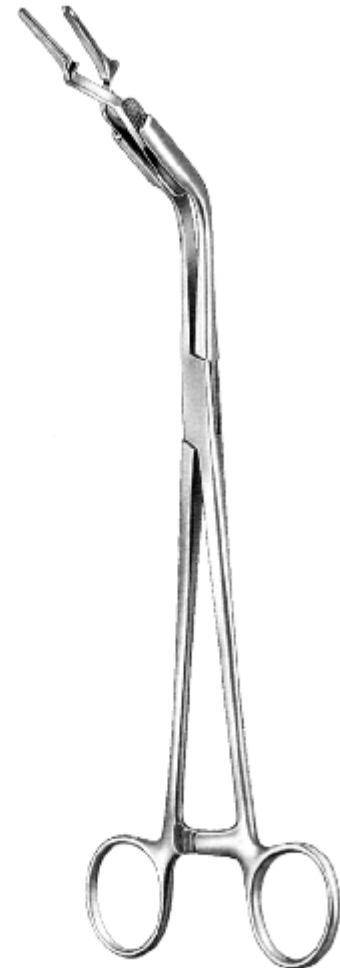
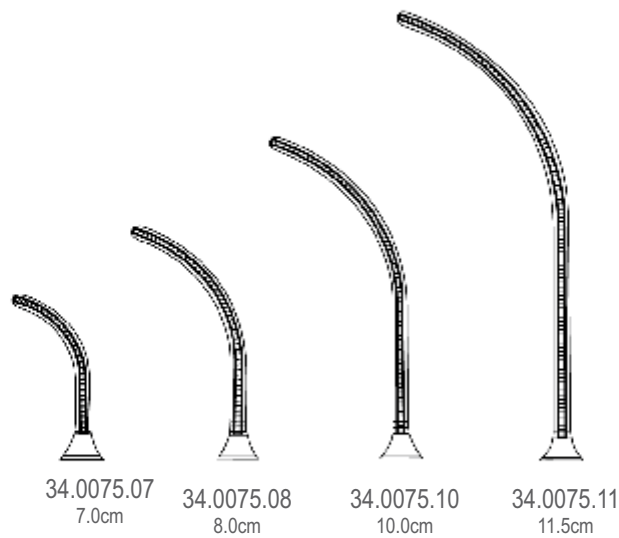

34.0080.23 23.0cm

CARDIOVASCULAR

Atrauma Bulldog Clamps
 Atrauma Bulldogklemmen
 Atrauma clamps bulldog
 Зажимы типа бульдог
 非创伤性斗牛犬夹

ALSO AVAILABLE IN TITANIUM

CARDIOVASCULAR

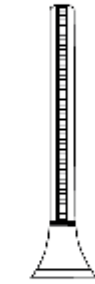

34.0084.09
9.0cm

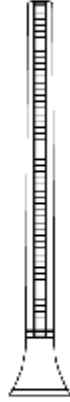

34.0084.11
11.0cm

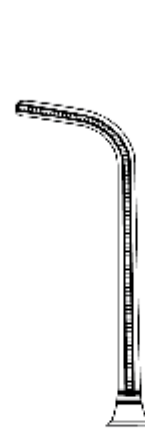

34.0085.09
9.0cm

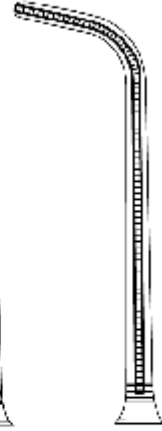

34.0085.11
11.0cm

GREGORY SOFT

GREGORY SOFT



34.0090.01

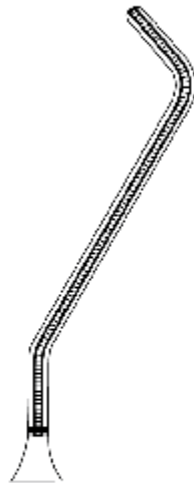

34.0090.02

GREGORY SOFT
11.0cm



SANTULLI
34.0094.07 7.0cm

Atrauma Bulldog Clamps
Atrauma Bulldogklemmen
Atrauma clamps bulldog
Зажимы типа бульдог
非创伤性斗牛犬夹



ALSO AVAILABLE IN TITANIUM



DE BAKEY-SATINSKY
34.0100.07 7.0cm

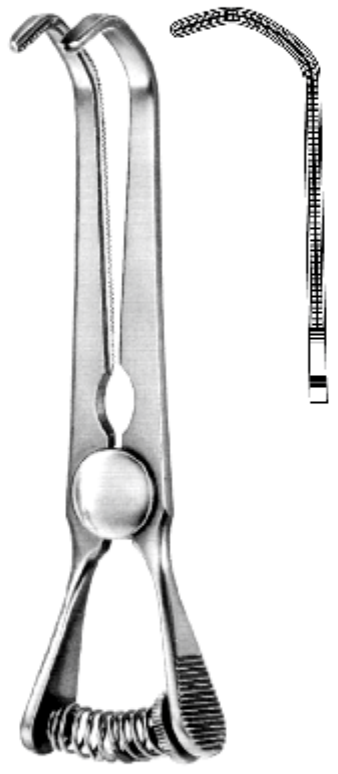

DE BAKEY-SATINSKY
34.0100.10 10.0cm

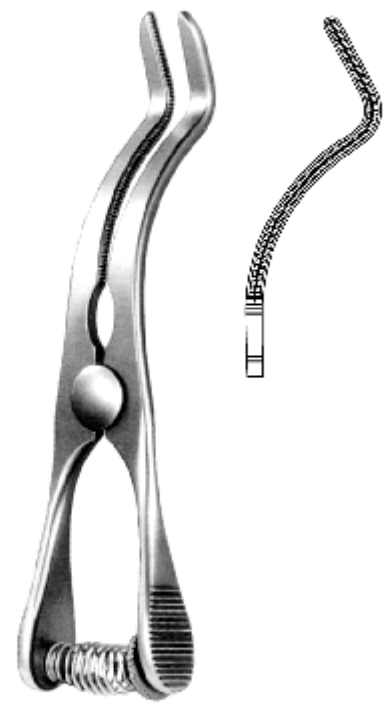

DE BAKEY-CAROTIS
34.0104.09 9.0cm

CARDIOVASCULAR

Atrauma Hemostatic Forceps
 Atrauma Arterienklemmen
 Atrauma hemostaticas pinzas
 Зажимы с атравматической нарезкой
 非创伤性止血钳

ALSO AVAILABLE IN TITANIUM

CARDIOVASCULAR

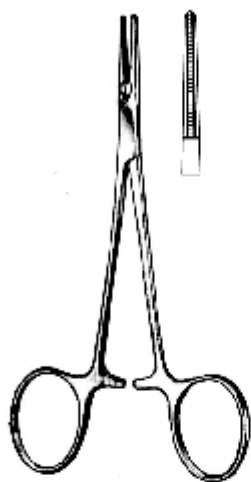

MOSQUITO
34.0110.12 12.0cm



MOSQUITO
34.0111.12 12.0cm

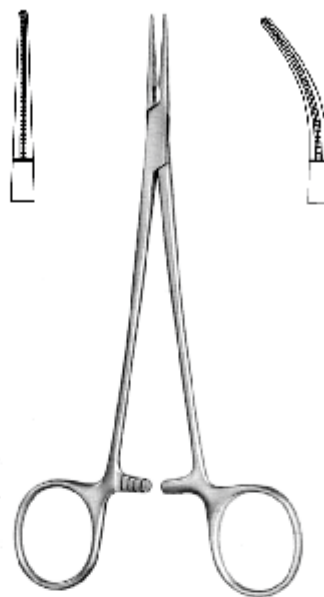

DE BAKEY-MOSQUITO
34.0120.15 15.0cm 34.0121.15

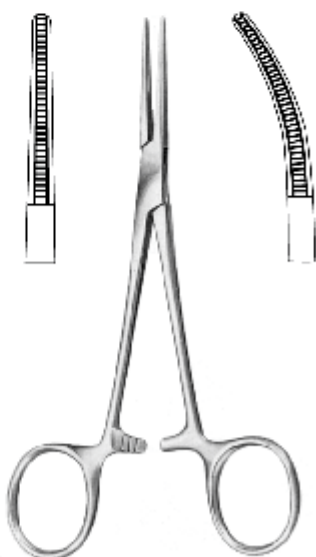

DE BAKEY-KELLY
34.0124.14 14.0cm 34.0125.14

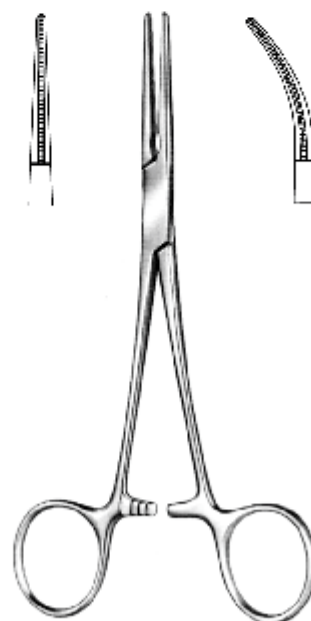

DE BAKEY-RAKIN
34.0130.16 16.0cm 34.0131.16

Atrauma Cardiovascular Forceps
Atrauma Cardiovascular-Klemmen
Atrauma pinzas-clamps cardiovasculares
Зажимы с атравматической нарезкой
非创伤性心血管钳

Hilton
PREMIUM STAINLESS STEEL

ALSO AVAILABLE IN TITANIUM



DE BAKEY
34.0134.10 10.0cm



DE BAKEY
34.0140.13 12.5cm

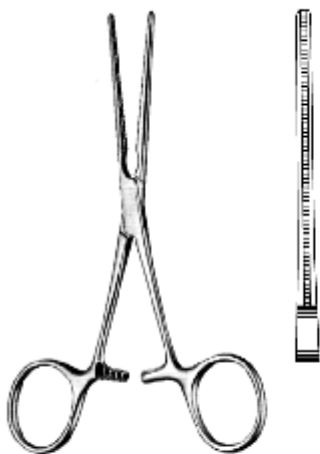

DE BAKEY
34.0150.12 13.0cm



DE BAKEY
34.0152.11 12.5cm

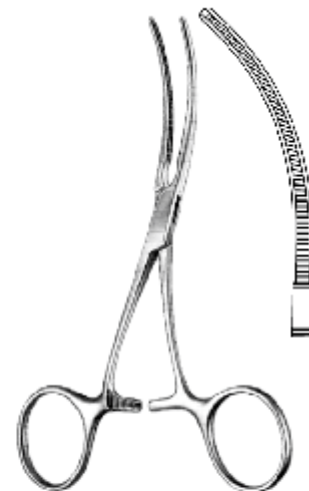

DE BAKEY
34.0154.12 12.5cm

CARDIOVASCULAR

ALSO AVAILABLE IN TITANIUM

CARDIOVASCULAR



HUSFELDT
34.0160.17 17.0cm

HUSFELDT
34.0162.17 17.0cm

HUSFELDT
34.0164.18 18.0cm

Atrauma Cardiovascular Forceps
 Atrauma Cardiovascular-Klemmen
 Atrauma pinzas-clamps cardiovasculares
 Зажимы с атравматической нарезкой
 非创伤性心血管钳



ALSO AVAILABLE IN TITANIUM

CARDIOVASCULAR

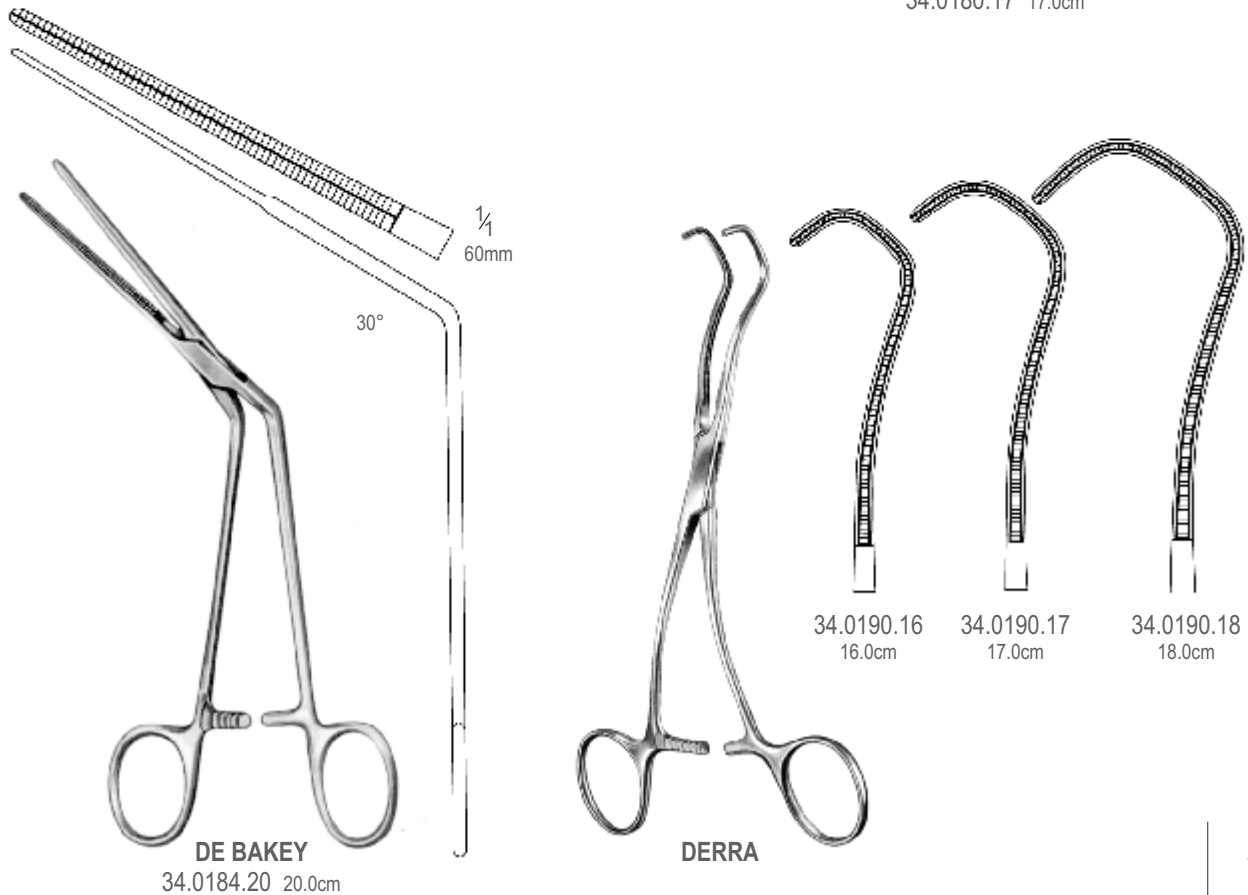
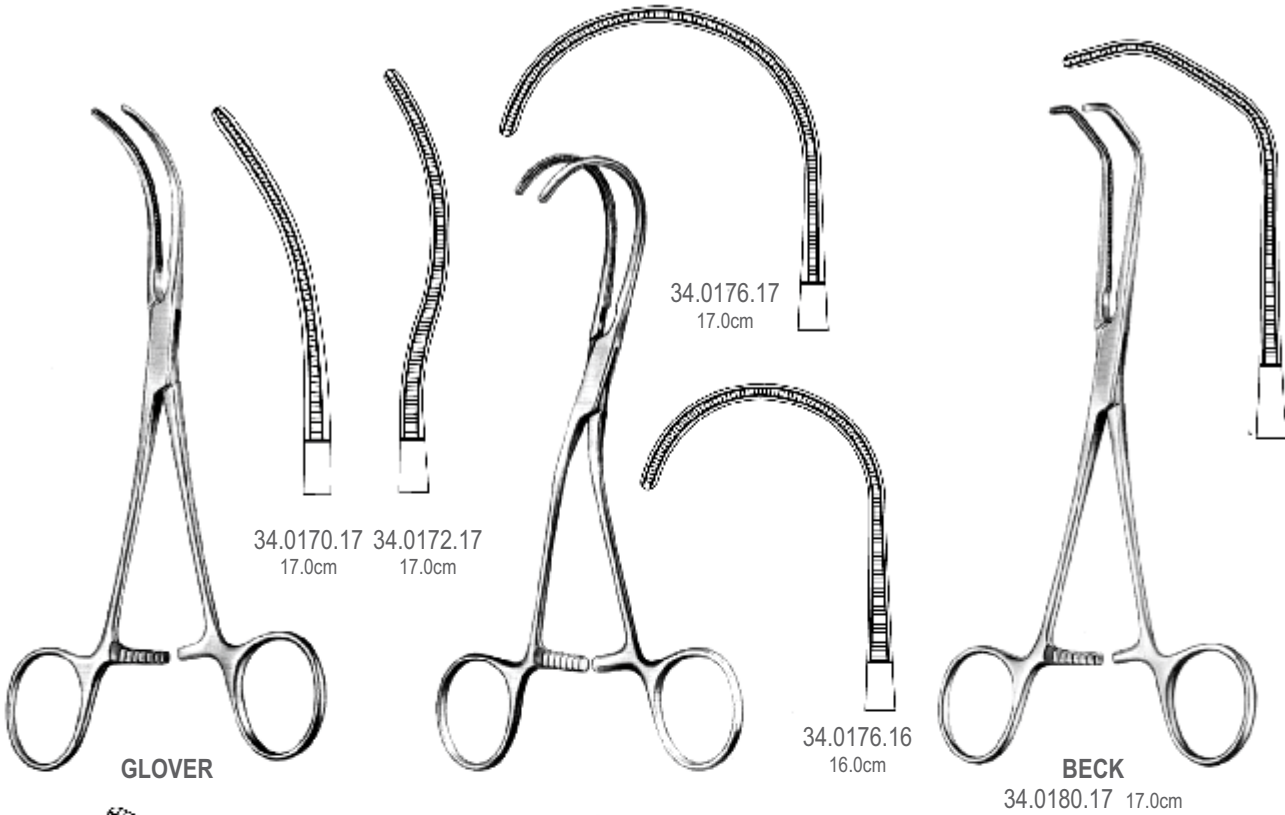

ALSO AVAILABLE IN TITANIUM

CARDIOVASCULAR

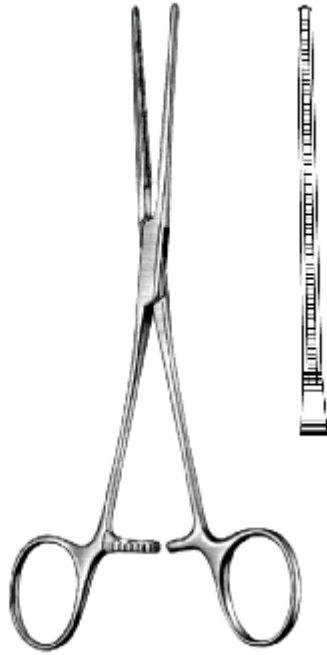

DE BAKEY
34.0194.17 17.0cm



DE BAKEY
34.0200.17 17.0cm

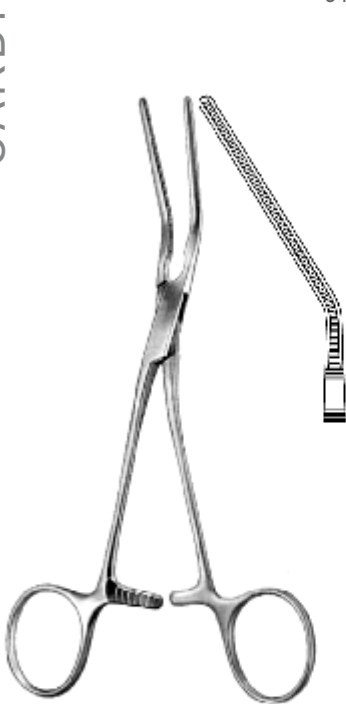

DE BAKEY
34.0204.16 16.0cm

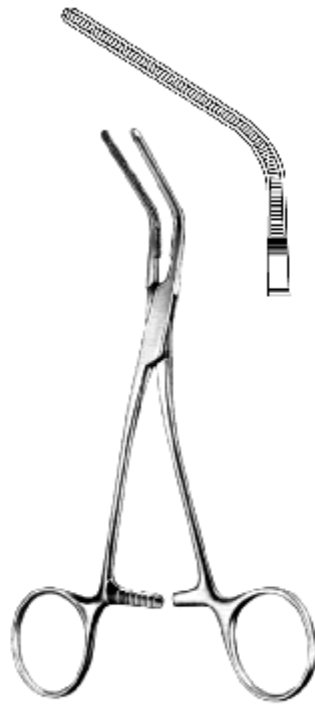

DE BAKEY
34.0210.15 15.0cm

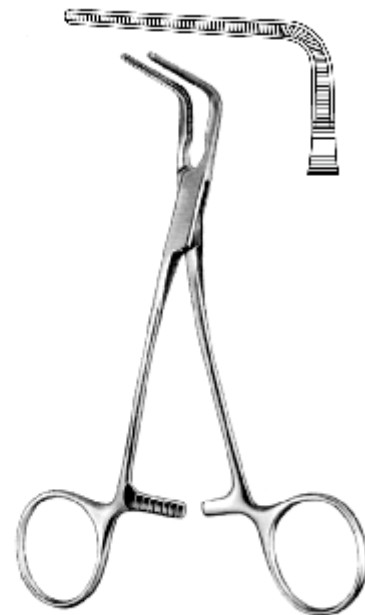

DE BAKEY
34.0214.15 15.0cm

Atrauma Hemostatic Forceps
 Atrauma Arterienklemmen
 Atrauma hemostaticas pinzas
 Зажимы с атравматической нарезкой
 非创伤性止血钳



ALSO AVAILABLE IN TITANIUM



DE BAKEY-PEAN

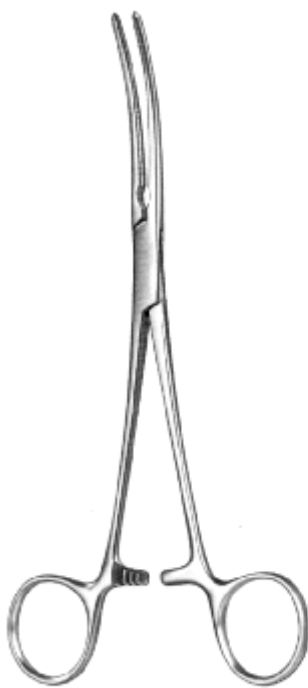
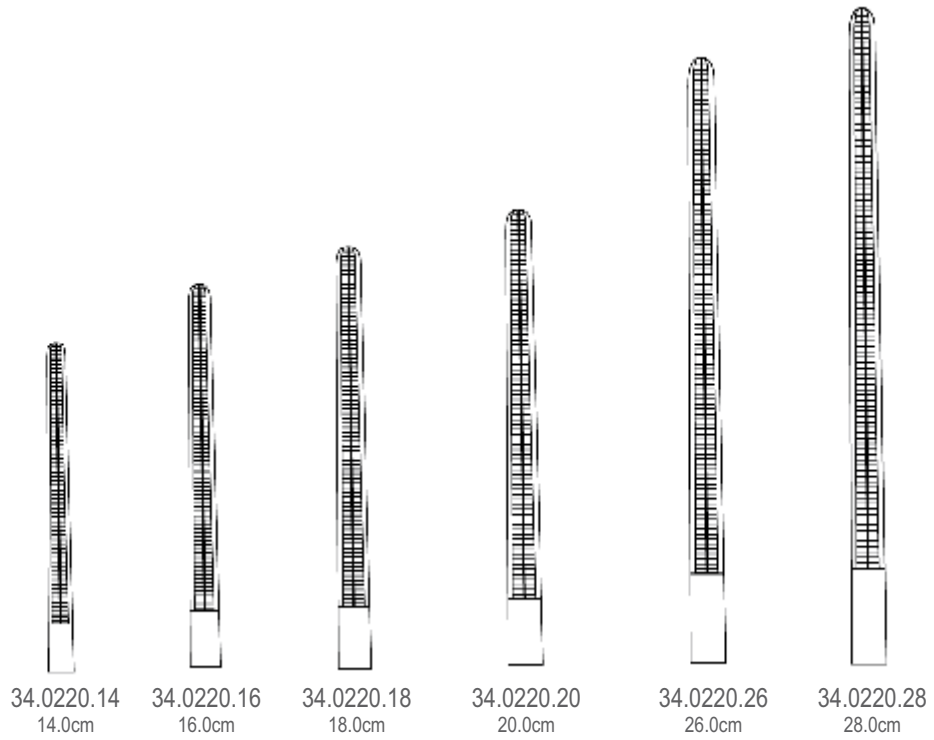

DE BAKEY-PEAN

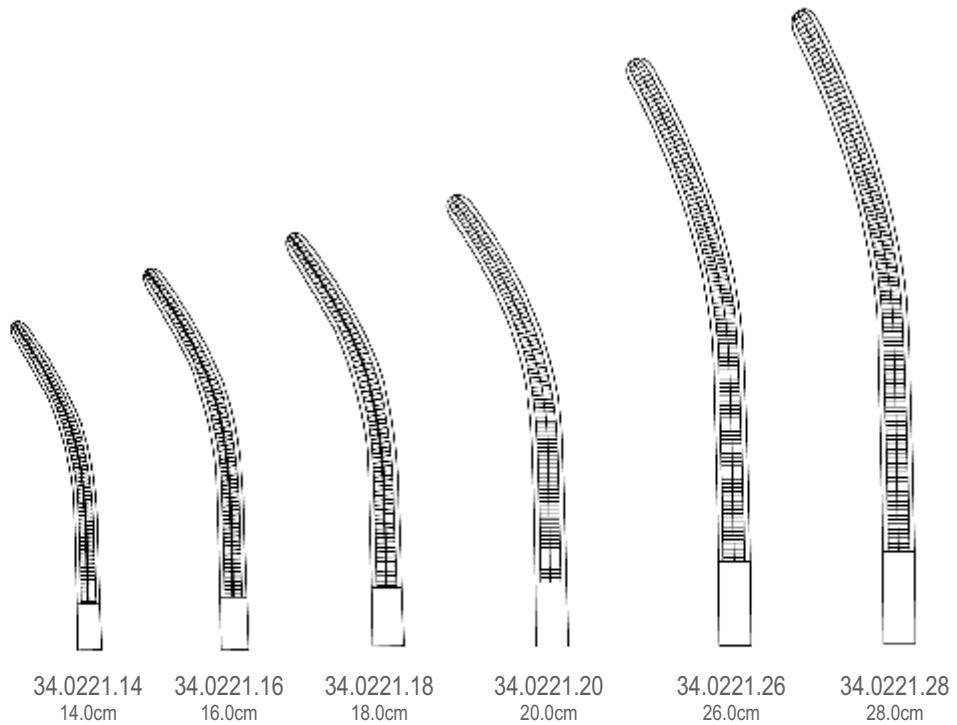

CARDIOVASCULAR

ALSO AVAILABLE IN TITANIUM

CARDIOVASCULAR

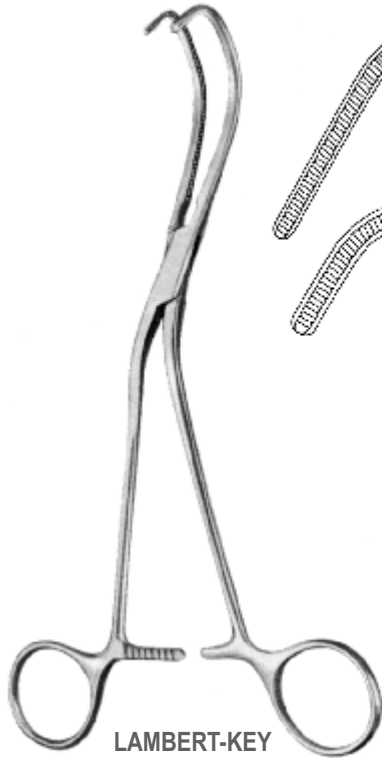

LAMBERT-KEY

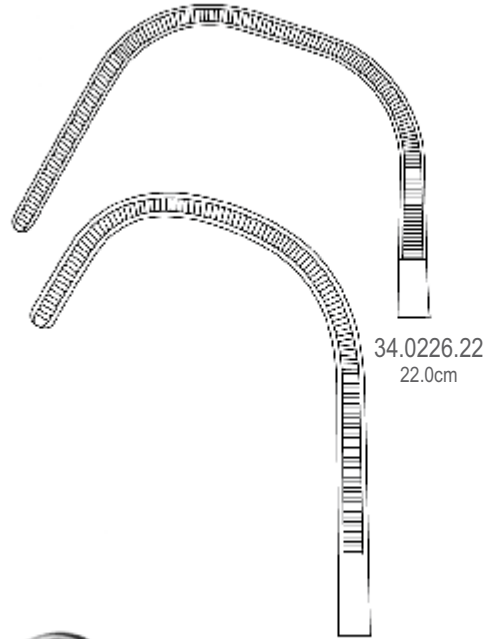

34.0226.22
22.0cm

34.0226.21
21.0cm

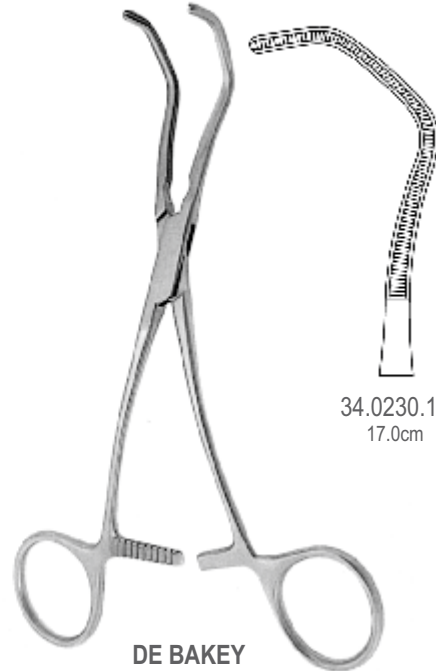

34.0230.17
17.0cm

DE BAKEY



POTTS

34.0234.22
22.0cm



34.0236.22
22.0cm

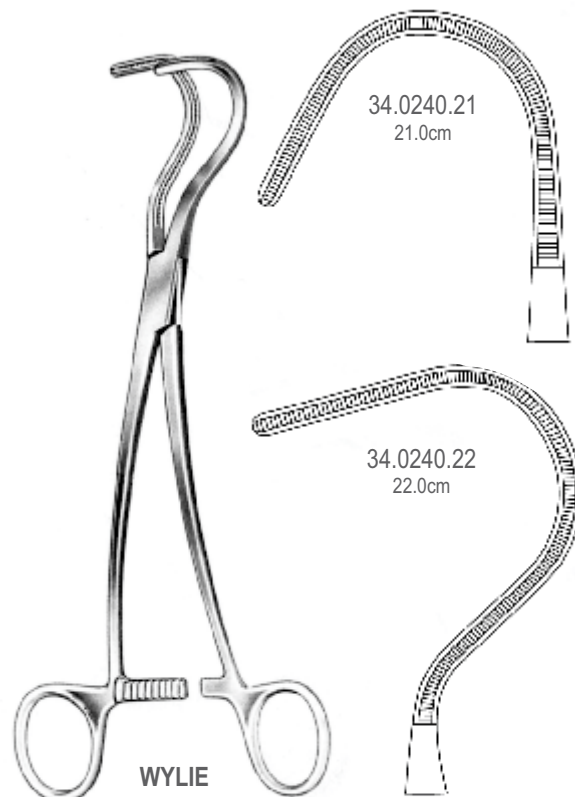

WYLIE

34.0240.21
21.0cm

34.0240.22
22.0cm

Atrauma Cardiovascular Forceps
 Atrauma Cardiovascular-Klemmen
 Atrauma pinzas-clamps cardiovasculares
 Зажимы с атравматической нарезкой
 非创伤性心血管钳



ALSO AVAILABLE IN TITANIUM

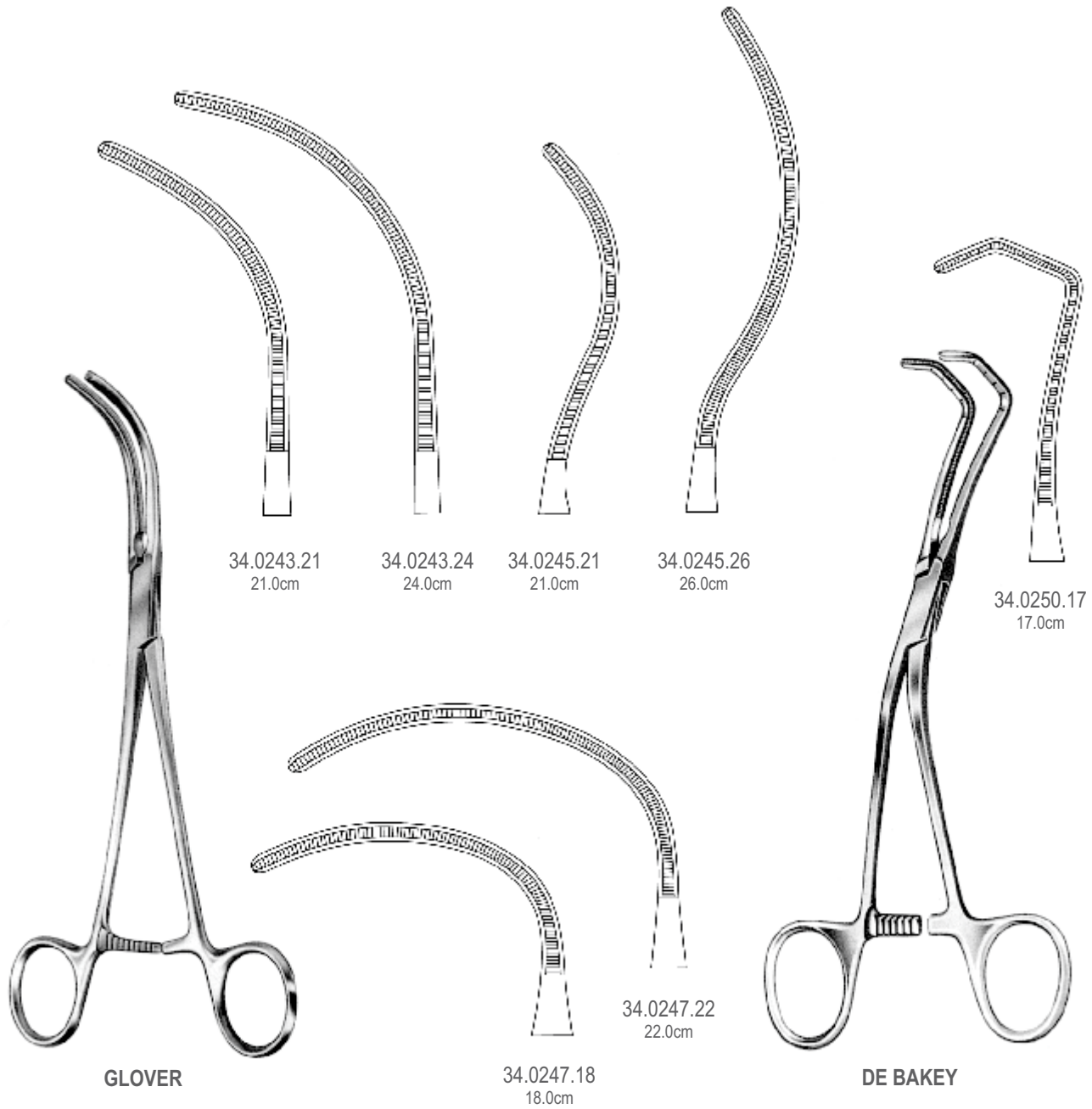

CARDIOVASCULAR

ALSO AVAILABLE IN TITANIUM

CARDIOVASCULAR

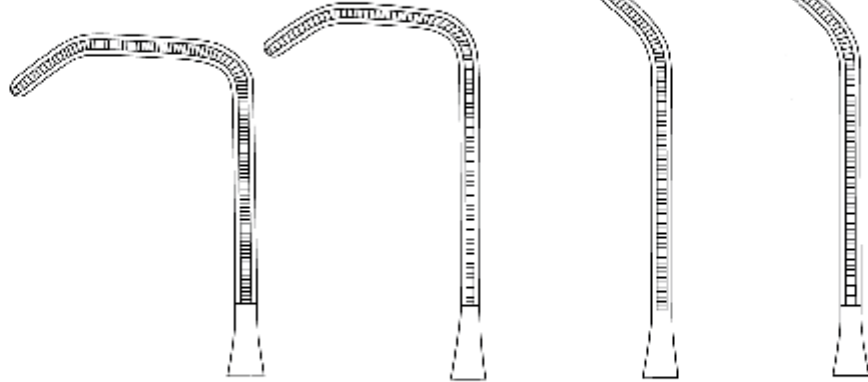

34.0254.16
16.5cm

34.0256.16
16.5cm

34.0254.18
18.0cm

34.0256.18
18.0cm

DE BAKEY-REYNOLDS

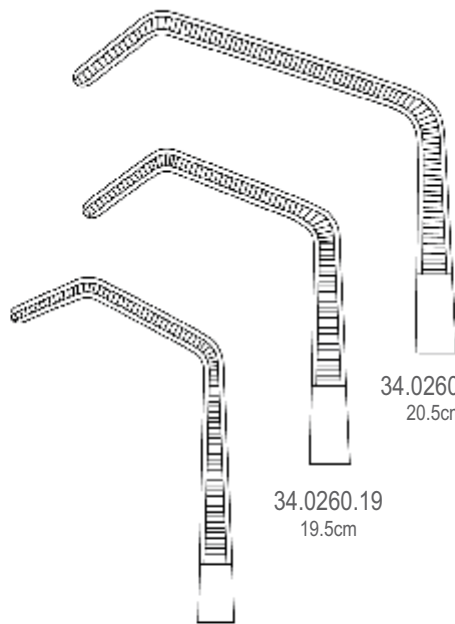
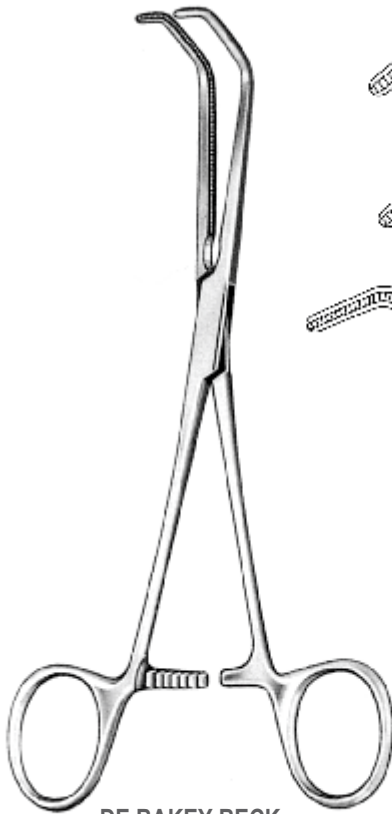

34.0260.16
16.5cm

34.0260.19
19.5cm

34.0260.20
20.5cm

DE BAKEY-BECK

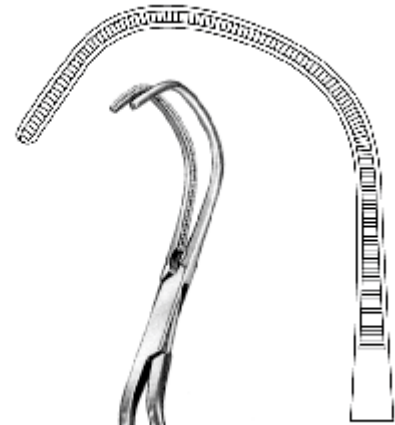

34.0264.27
27.0cm

LIDDLE

Aortic Aneurysm Clamps
Aorta-Aneurysmaklemmen
Pinzas - clamps para aneurisma
Зажимы с атравматической нарезкой, Зажимы для аорты
主动脉动脉瘤夹



ALSO AVAILABLE IN TITANIUM

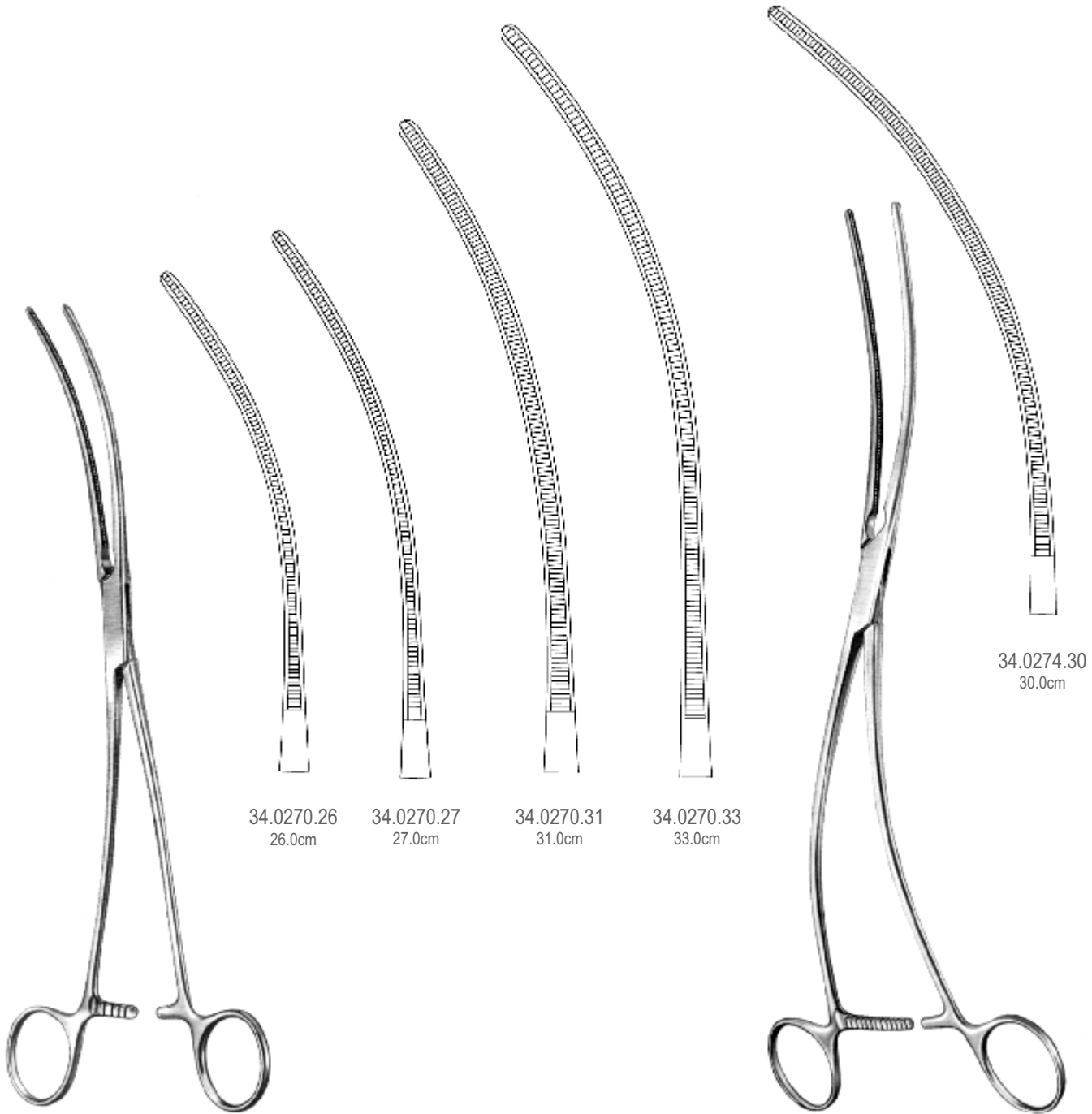

34.0270.26
26.0cm

34.0270.27
27.0cm

34.0270.31
31.0cm

34.0270.33
33.0cm

34.0274.30
30.0cm

CARDIOVASCULAR

ALSO AVAILABLE IN TITANIUM

CARDIOVASCULAR

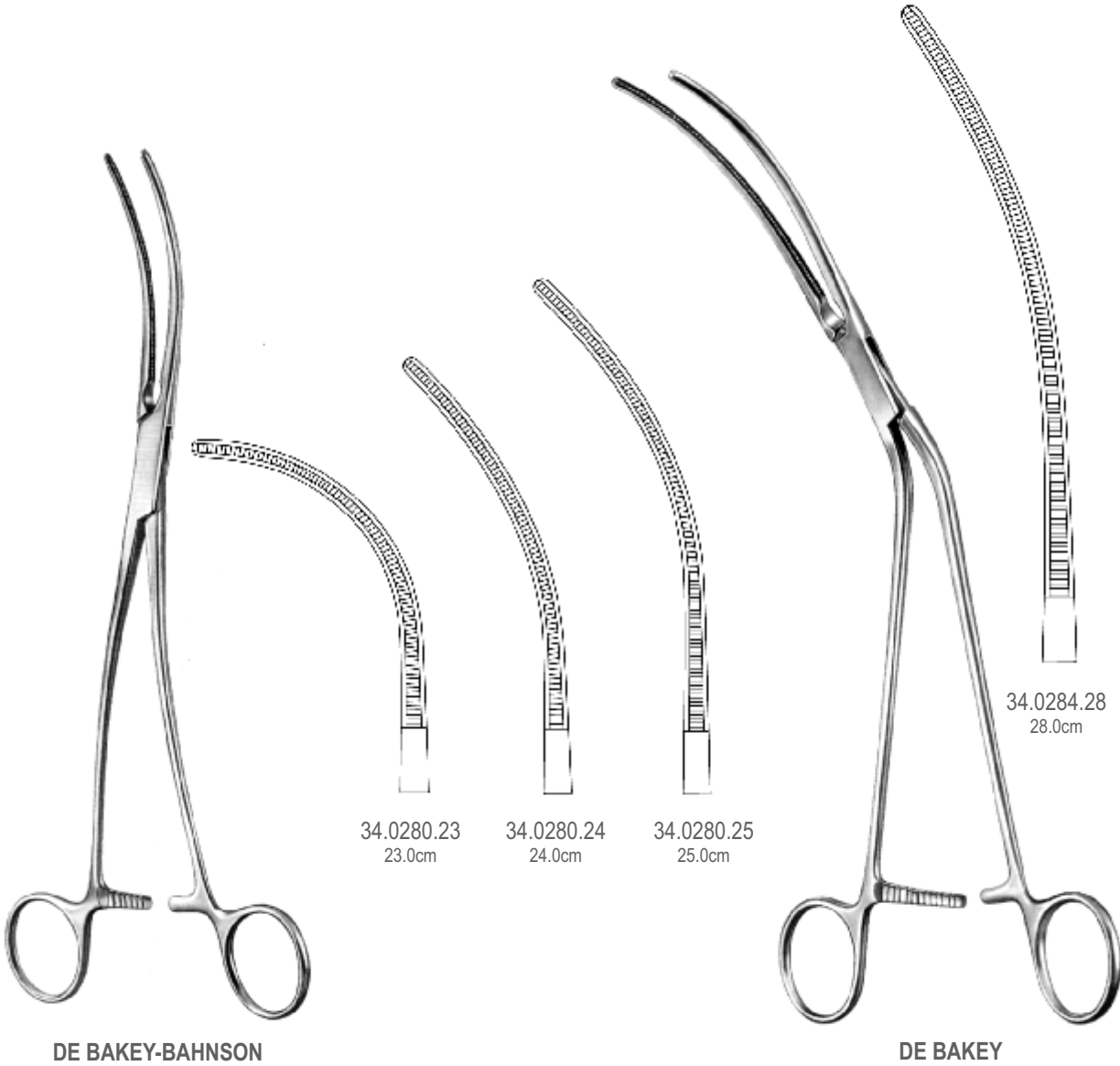

Aortic Clamps
Aortaklemmen
Pinzas-clamps para aorta
Зажимы с атравматической нарезкой, Зажимы для аорты
主动脉夹



ALSO AVAILABLE IN TITANIUM

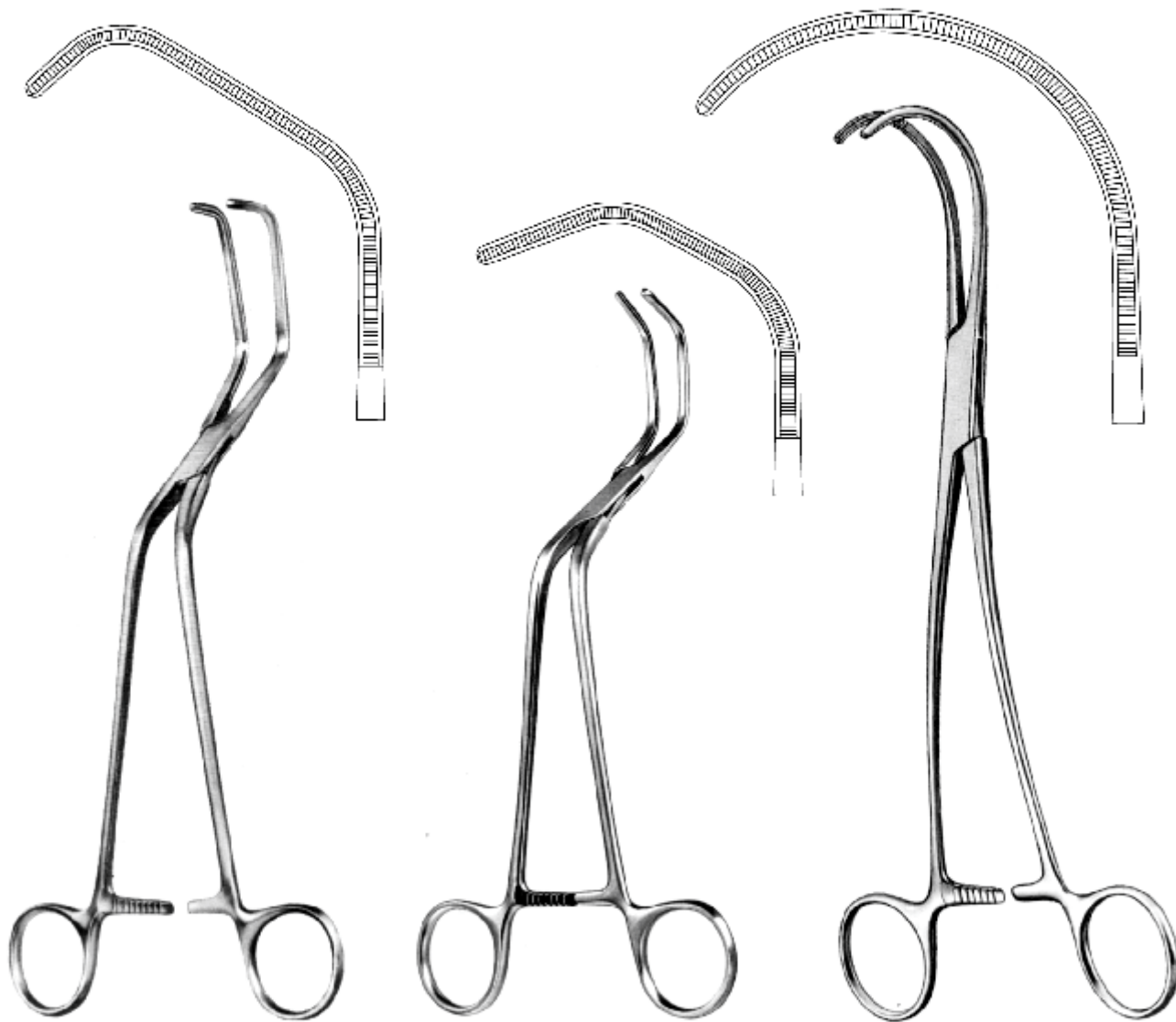

OCHSNER
34.0290.23 23.5cm
34.0290.26 26.0cm

DIETRICH
34.0294.21 21.0cm

DE BAKEY
34.0300.26 26.0cm

CARDIOVASCULAR

Aortic Clamps
Aortaklemmen
Piznas-clamps para aorta
Зажимы с атравматической нарезкой, Зажимы для аорты
主动脉夹

ALSO AVAILABLE IN TITANIUM

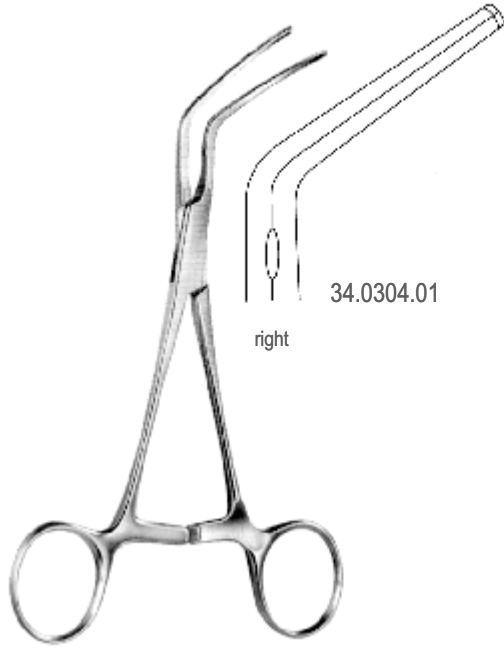

34.0304.01
right

SUBRAMANIAN
16.0cm

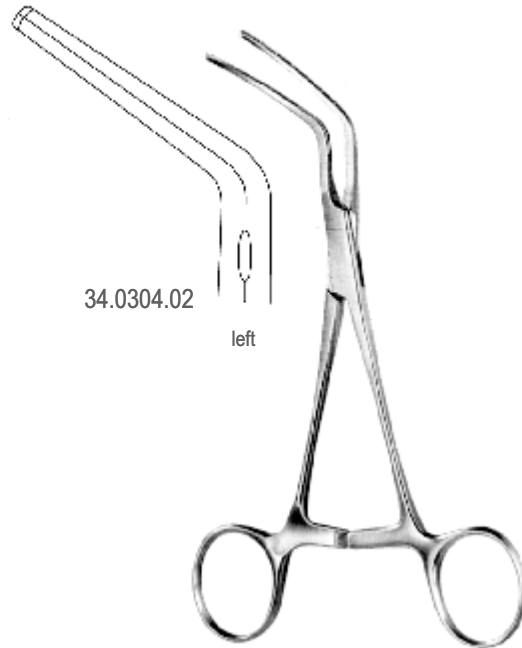

34.0304.02
left

SUBRAMANIAN
16.0cm

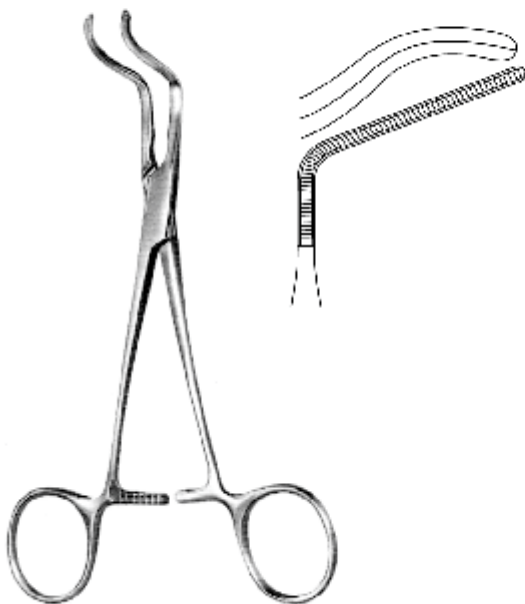

SUBRAMANIAN-MINIATURE
34.0310.15 15.5cm

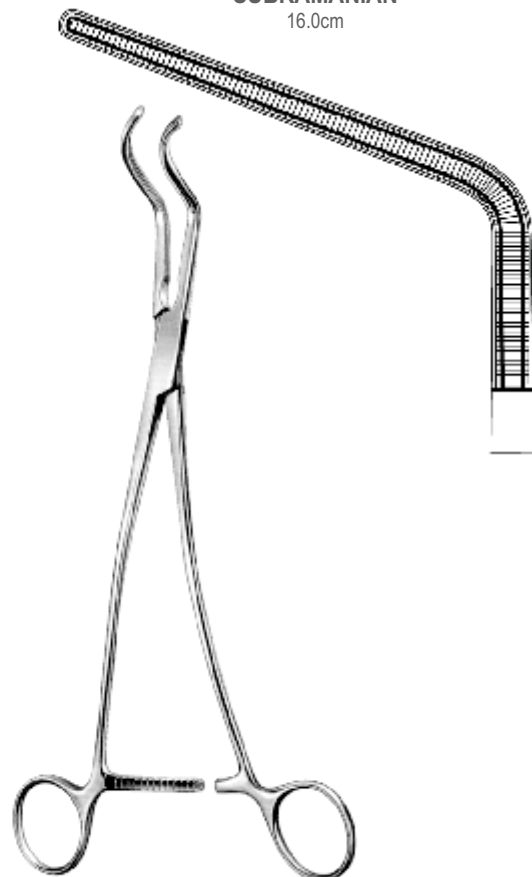

DE BAKEY
34.0314.27 27.0cm

CARDIOVASCULAR

Aortic Clamps
Aortaklemmen
Pinzas-clamps para aorta
Зажимы с атравматической нарезкой, Зажимы для аорты
主动脉夹



ALSO AVAILABLE IN TITANIUM

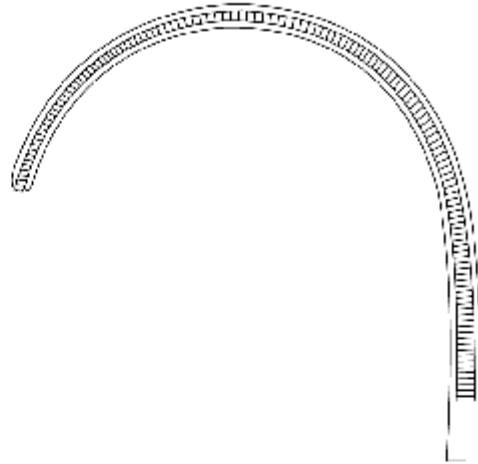
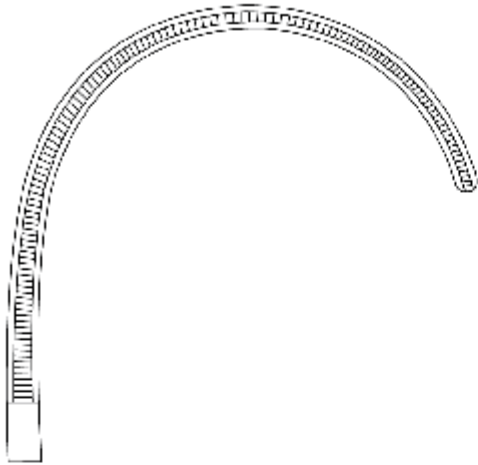

WEBER
34.0320.01 26.0cm



WEBER
34.0320.02 26.0cm

CARDIOVASCULAR

ALSO AVAILABLE IN TITANIUM

CARDIOVASCULAR



34.0324.18
18.0cm

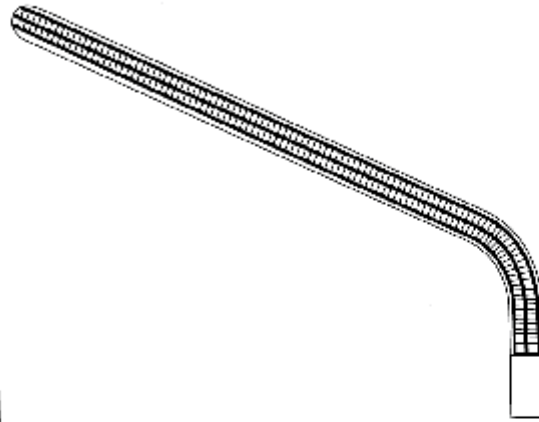

34.0324.20
20.0cm



MORRIS - DE BAKAY

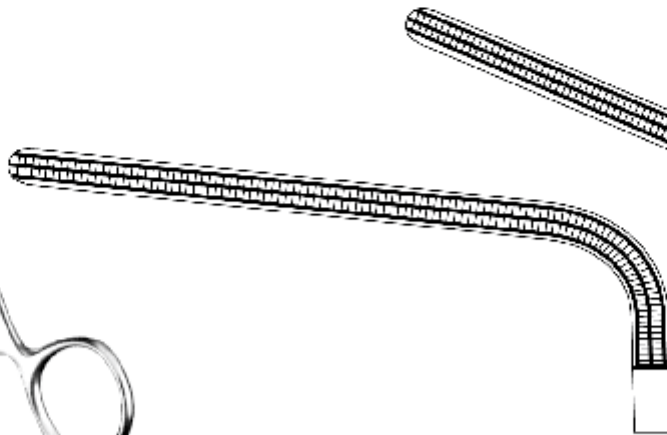

34.0324.23
23.0cm

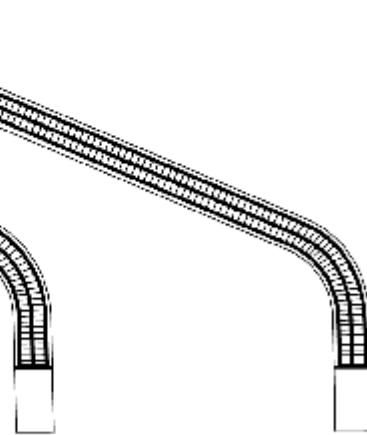

34.0324.25
25.0cm

Tangential Occlusion Clamps
 Tangentialklemmen
 Pinzas-clamps para oclusion tangencial
 Зажимы с атравматической нарезкой
 切向闭塞夹



ALSO AVAILABLE IN TITANIUM



DE BAKEY
SATINSKY



SATINSKY

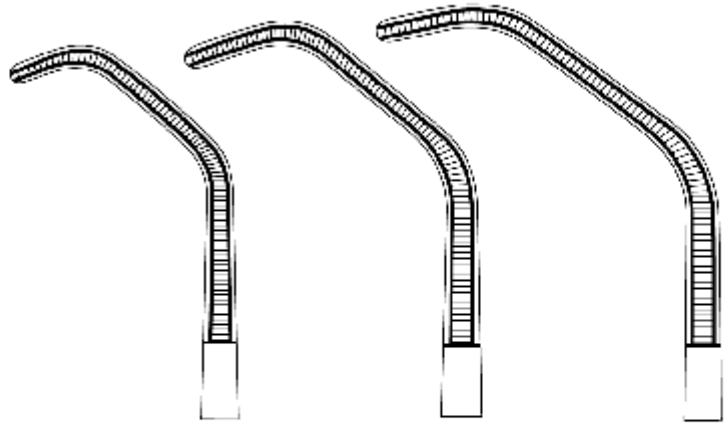
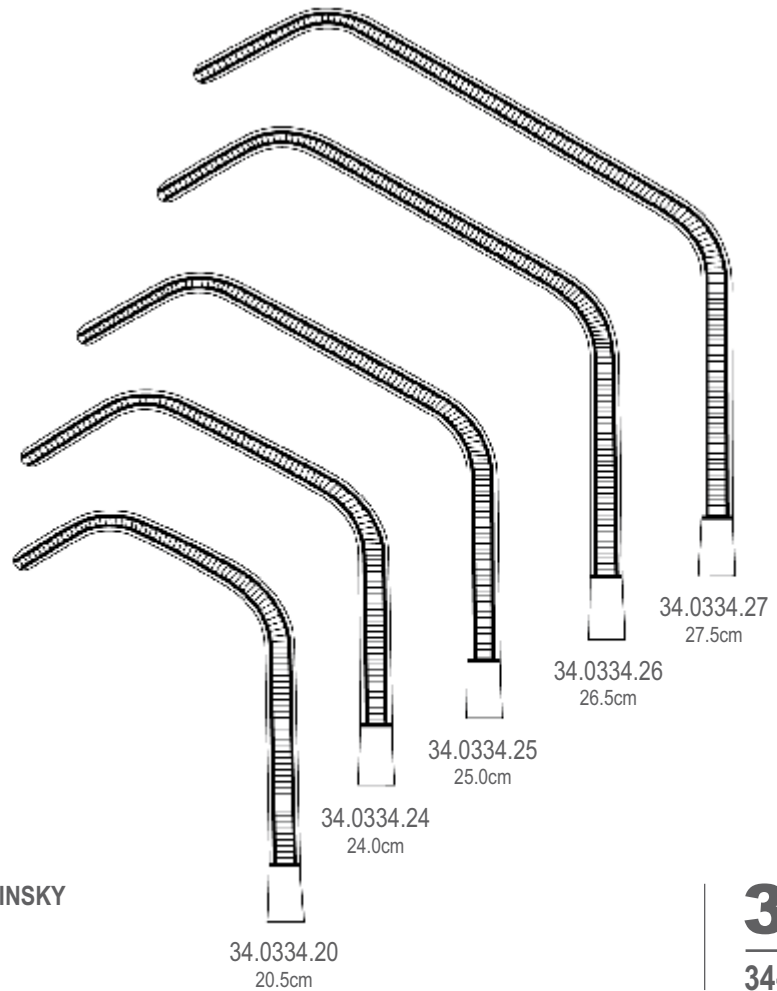

Fig.1 34.0330.23 23.5cm
 Fig.2 34.0330.24 24.0cm
 Fig.3 34.0330.25 25.0cm



34.0334.20 20.5cm
 34.0334.24 24.0cm
 34.0334.25 25.0cm
 34.0334.26 26.5cm
 34.0334.27 27.5cm

CARDIOVASCULAR

Coarctation forceps, Renal Artery Clamp

Coarctationsklemmen, Nieren-Arterienklemme

Pinzas-clamps para coarctacion, pinzas-clamps para arteria renal

Зажимы с атравматической нарезкой, Зажимы для коарктации, Зажимы для почечной артерии
缩窄钳, 肾动脉夹

ALSO AVAILABLE IN TITANIUM

CARDIOVASCULAR

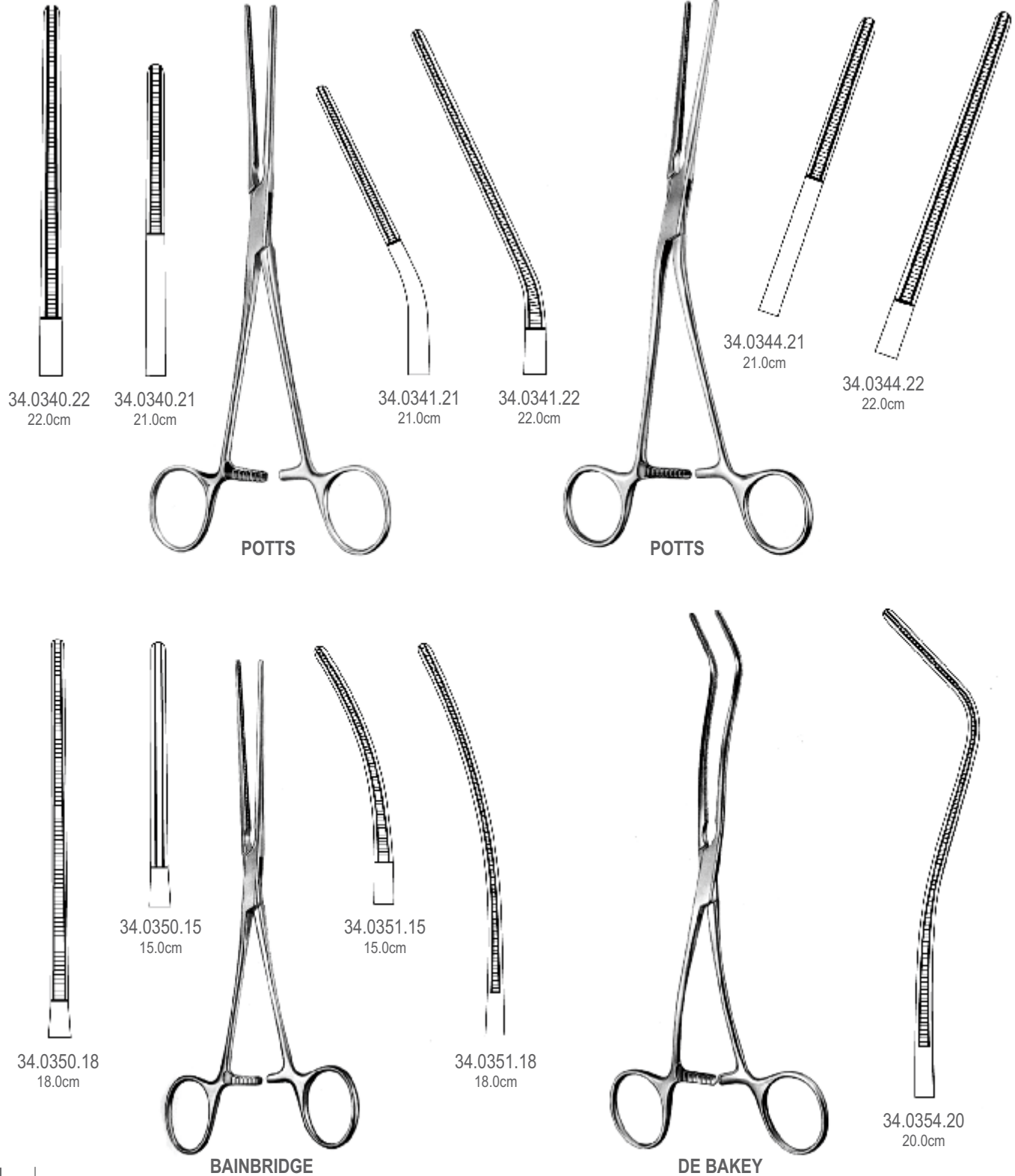

Profunda Clamps, Peripheral Vascular Clamps
Profundaklemmen, Peripheral-Gefaßklemmen

Pinzas-clamps para la profunda, pinzas-clamps para vasos perifericos



Зажимы с атравматической нарезкой, Зажимы для глубоких полостей, Периферийные сосудистые зажимы
周围血管夹

ALSO AVAILABLE IN TITANIUM



GREGORY



34.0360.14
14.0cm

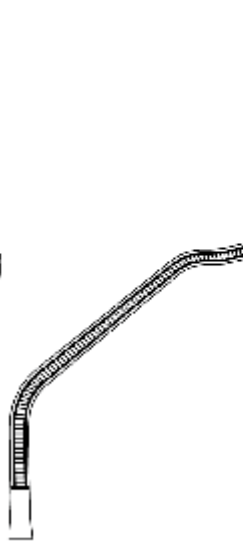

34.0360.16
16.0cm



34.0360.18
18.0cm

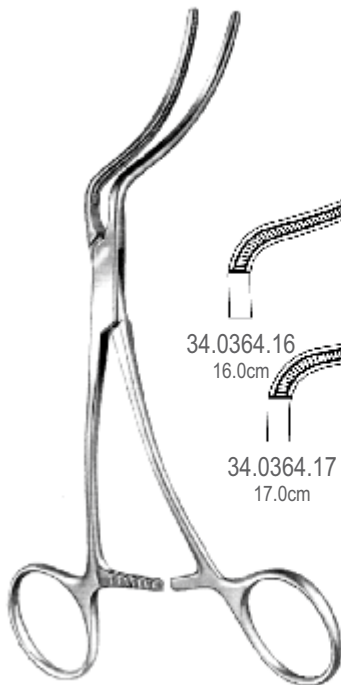

34.0364.16
16.0cm

34.0364.17
17.0cm

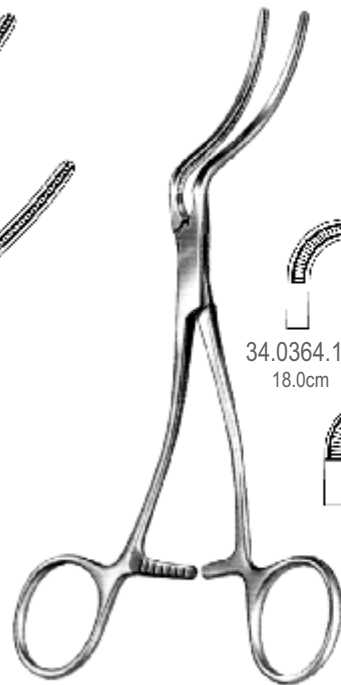

34.0364.18
18.0cm

34.0364.20
20.0cm

CARDIOVASCULAR

Peripheral Vascular Clamps

Peripheral-GefaßKlemmen

Pinzas-clamps para vasos perifericos

Зажимы с атравматической нарезкой, Периферийные сосудистые зажимы

周围血管夹

ALSO AVAILABLE IN TITANIUM

CARDIOVASCULAR



34.0370.16
16.0cm

DE BAKEY

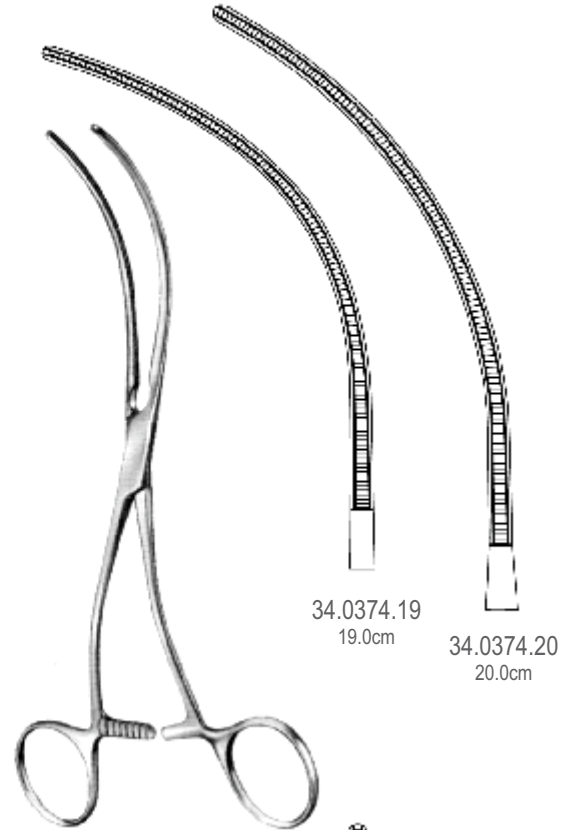

34.0374.19
19.0cm

34.0374.20
20.0cm

DE BAKEY

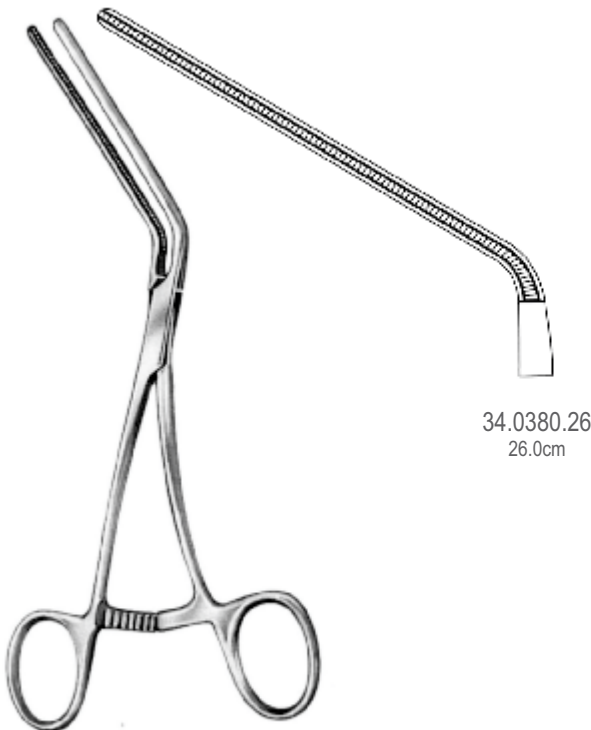

34.0380.26
26.0cm

DE BAKEY

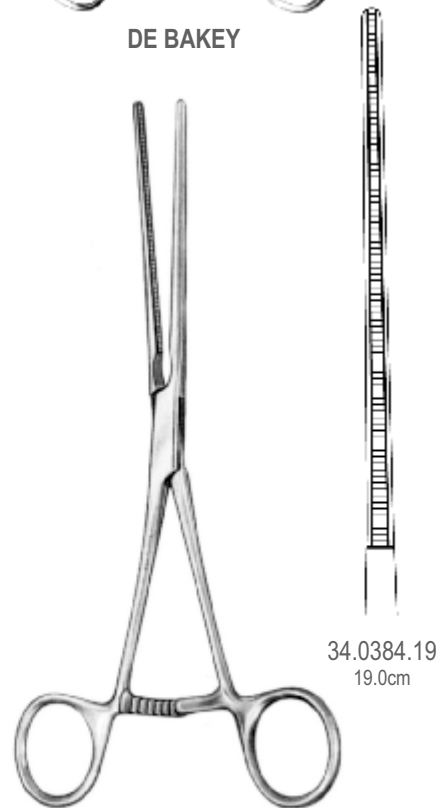

34.0384.19
19.0cm

LELAND JONES

Peripheral Vascular Clamps
 Peripheral-Gefaßklemmen
 Pinzas-clamps para vasos perifericos
 Зажимы с атравматической нарезкой, Периферийные сосудистые зажимы
 周围血管夹



ALSO AVAILABLE IN TITANIUM



LELAND JONES

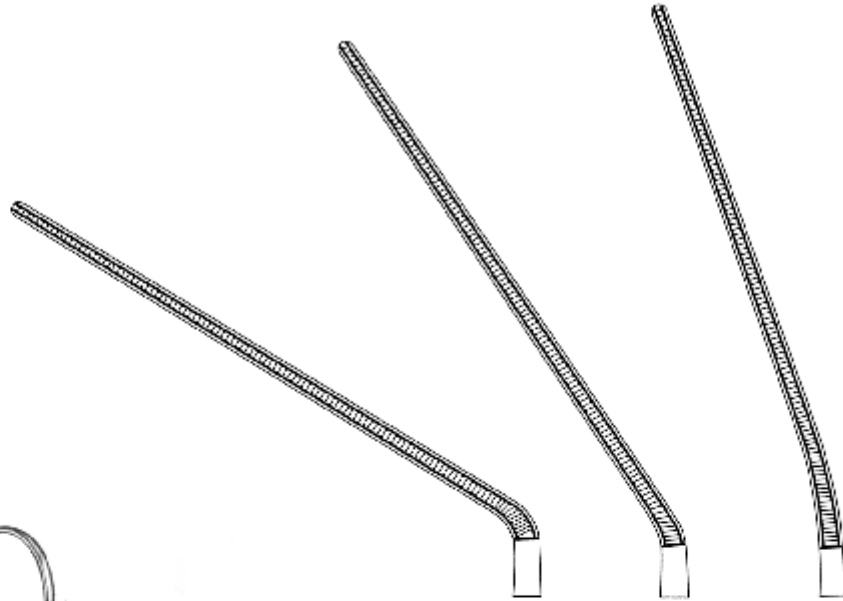

34.0390.18
18.0cm

34.0390.19
19.0cm

34.0390.20
20.0cm



DALE

34.0394.18
18.5cm



DALE

34.0400.17
17.0cm

34.0400.18
18.0cm

34.0400.19
19.0cm

CARDIOVASCULAR

Ligature Clamps

Ligaturklemmen

Pinzas para ligadura

Зажимы с атравматической нарезкой, Зажимы лигатурные

结扎夹

ALSO AVAILABLE IN TITANIUM

CARDIOVASCULAR



DE BAKEY



34.0404.19
19.0cm



34.0404.23
23.0cm



34.0410.24
24.0cm

DE BAKEY



34.0414.24
24.0cm

DE BAKEY

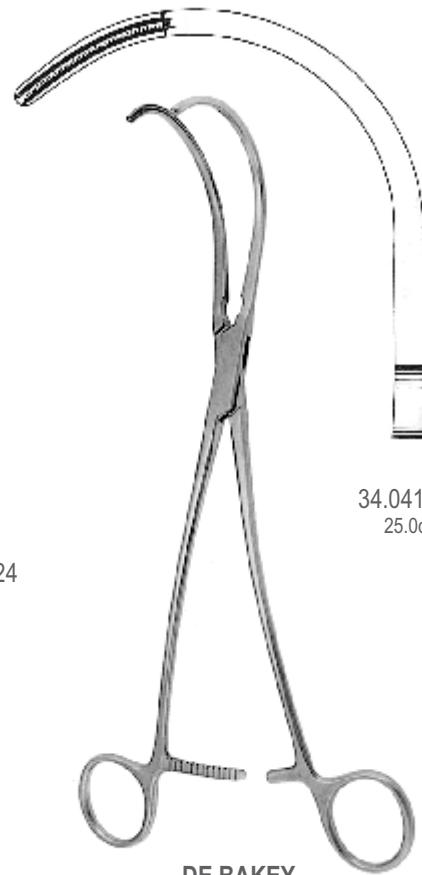

34.0414.25
25.0cm

DE BAKEY

Auricle Clamps, Bronchus Clamps
 Aurikeklappen, Bronchusklemmen
 Pinzas clamps para auricula, pinzas clamps bronquiales
 Зажимы с атравматической нарезкой, Зажимы для предсердия, Зажимы для бронхов
 耳廓线夹, 支气管夹



ALSO AVAILABLE IN TITANIUM



HARKEN
24.0cm



34.0420.01

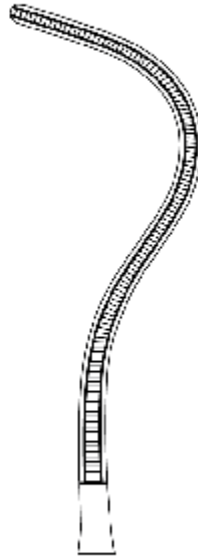

34.0420.02

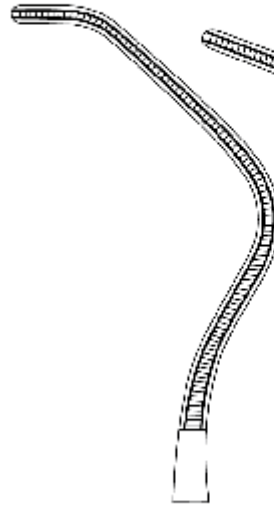

34.0420.03

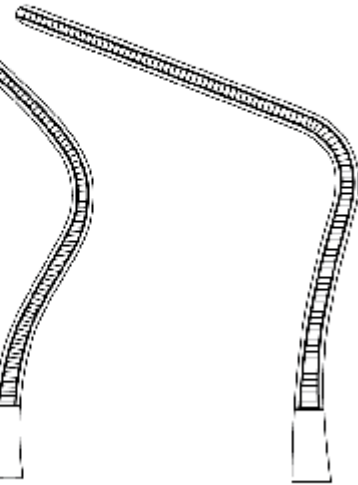

34.0420.04



LEES

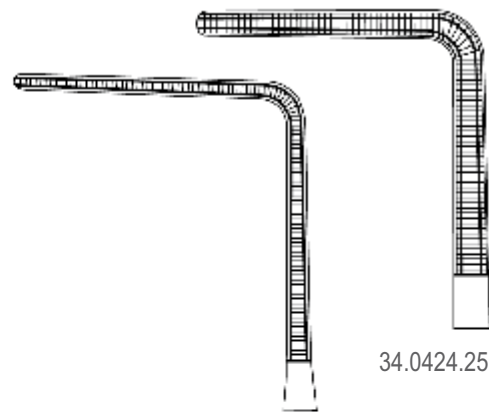

34.0424.23 23.0cm

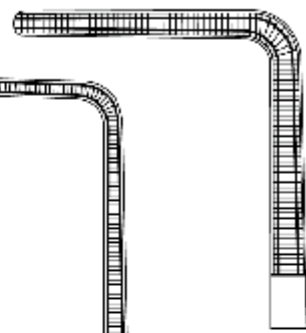

34.0424.25 25.0cm



LEES

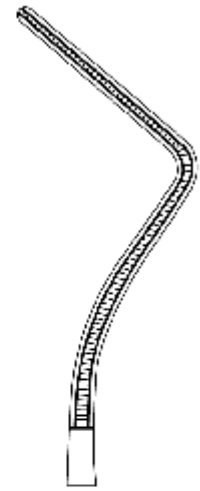

34.0430.25 25.0cm

CARDIOVASCULAR

ALSO AVAILABLE IN TITANIUM

CARDIOVASCULAR



34.0434.21
21.0cm



34.0434.23
23.0cm



34.0434.27
27.0cm



34.0434.31
31.0cm

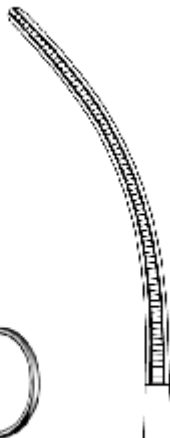

34.0435.21
21.0cm



34.0435.23
23.0cm



34.0435.27
27.0cm



34.0435.31
31.0cm

Multi Purpose Clamps
 Mehrzweckklemmen
 Pinzas-clamps para usos varios
 Зажимы с атравматической нарезкой
 非创伤性心血管钳



ALSO AVAILABLE IN TITANIUM

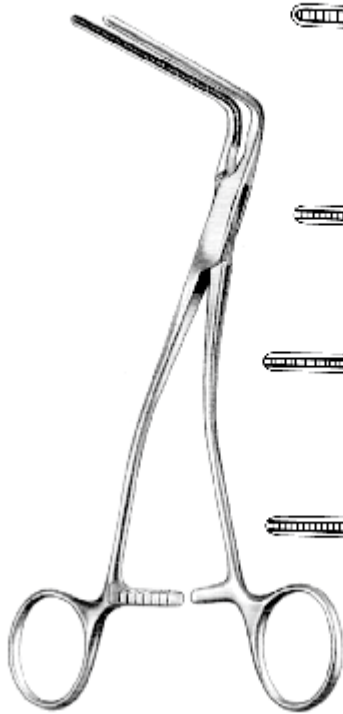

DE BAKEY

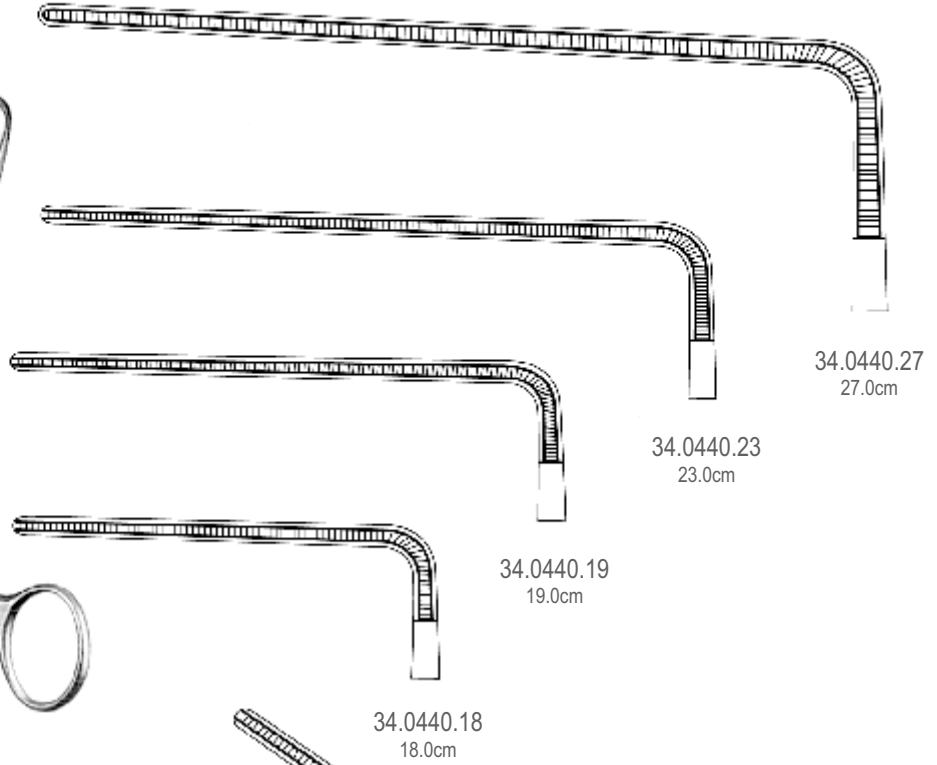

DE BAKEY

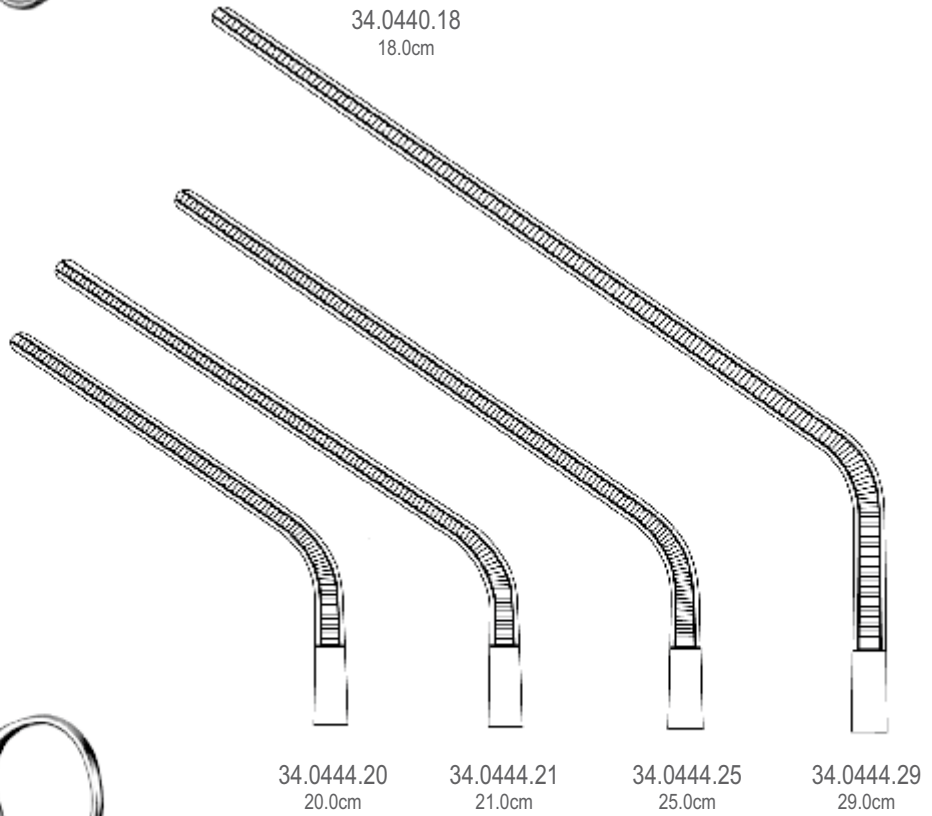

CARDIOVASCULAR

ALSO AVAILABLE IN TITANIUM

CARDIOVASCULAR

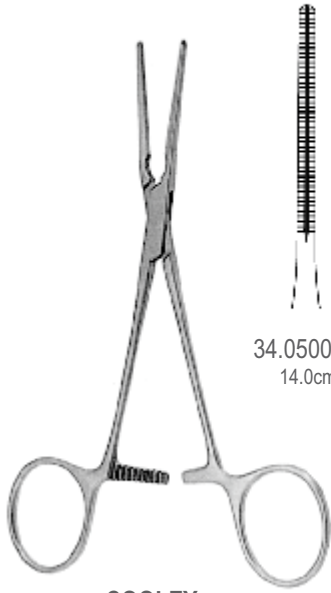

34.0500.01
14.0cm

COOLEY



34.0500.02
14.0cm

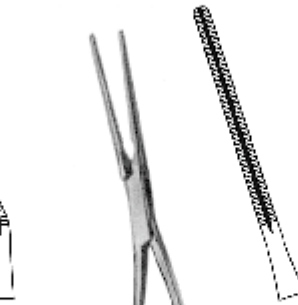

34.0500.03
14.0cm

COOLEY



34.0500.04
14.0cm

COOLEY



34.0500.05
14.0cm



34.0504.17
17.0cm

COOLEY

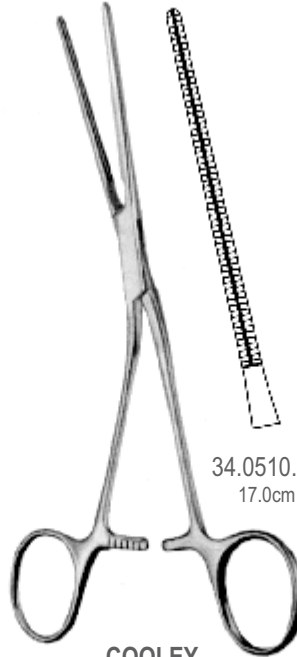

34.0510.17
17.0cm

COOLEY

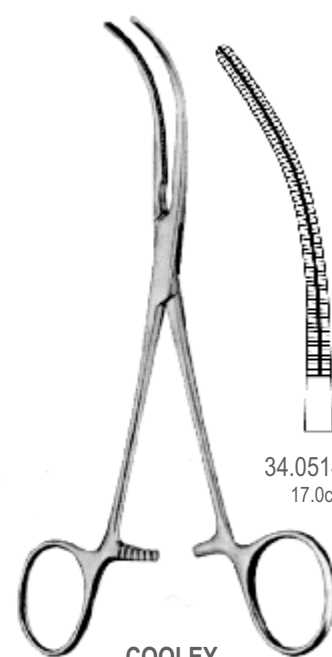

34.0514.17
17.0cm

COOLEY

Atrauma Cardiovascular Forceps
 Atrauma Cardiovascular-Klemmen
 Atrauma pinzas-clamps cardiovasculares
 Зажимы с атравматической нарезкой
 非创伤性心血管钳



ALSO AVAILABLE IN TITANIUM



COOLEY
 34.0520.17 17.0cm

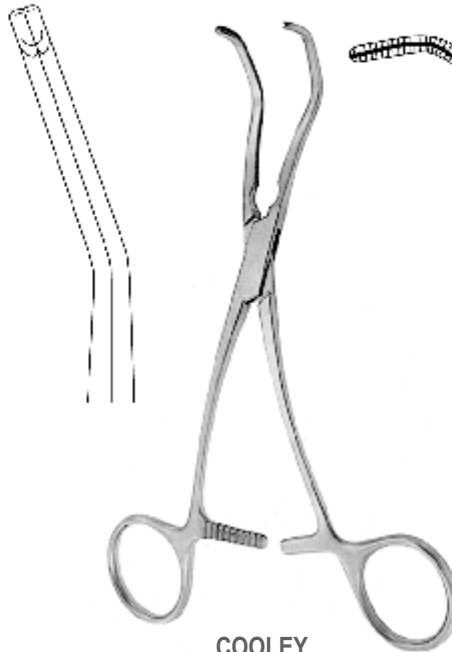

COOLEY
 34.0524.16 16.0cm

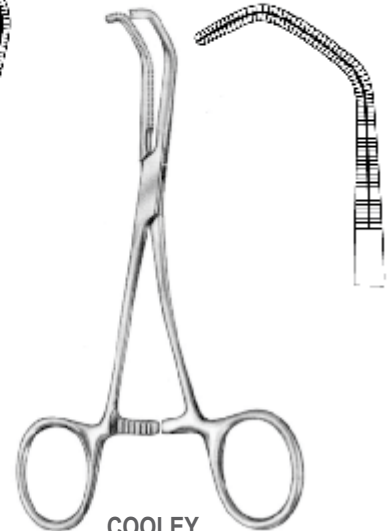

COOLEY
 34.0530.14 14.0cm

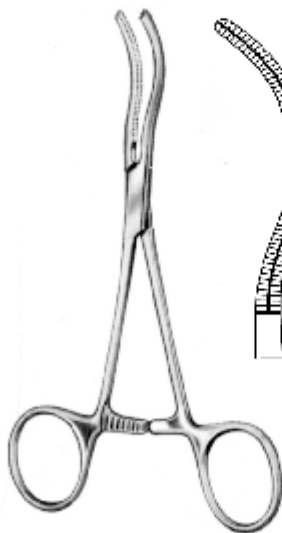

COOLEY
 34.0534.14 14.0cm

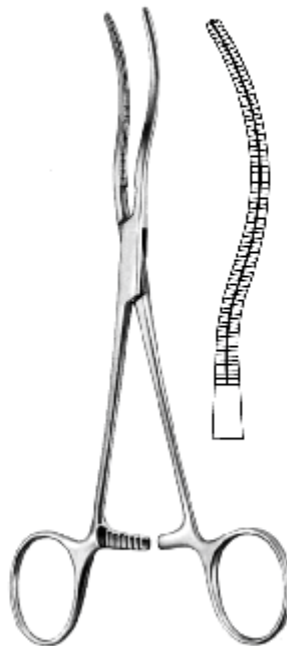

COOLEY
 34.0540.17 17.0cm

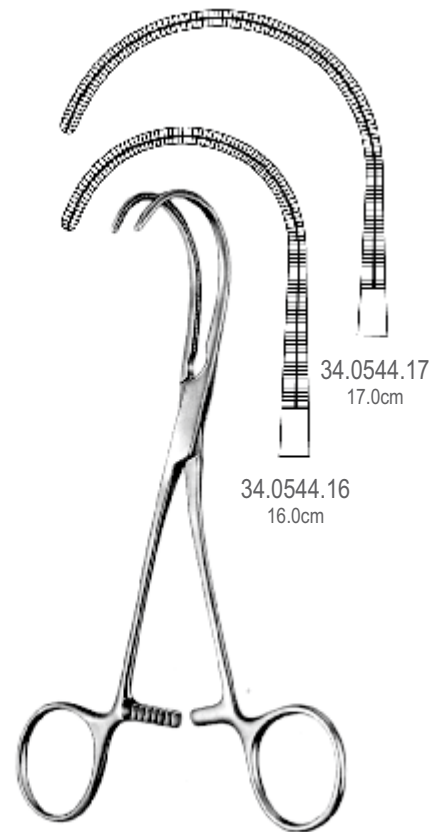

34.0544.16
 16.0cm

34.0544.17
 17.0cm

COOLEY

CARDIOVASCULAR

ALSO AVAILABLE IN TITANIUM

CARDIOVASCULAR



COOLEY-DERRA

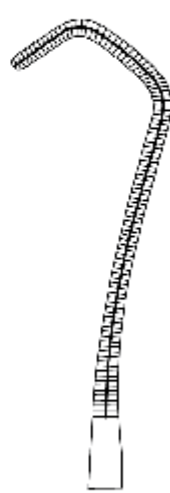

34.0550.16
16.0 cm

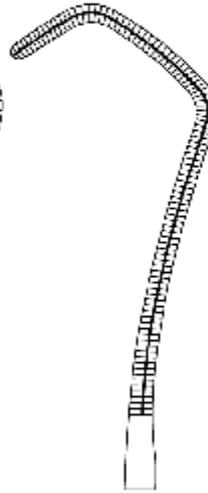

34.0550.17
17.0 cm

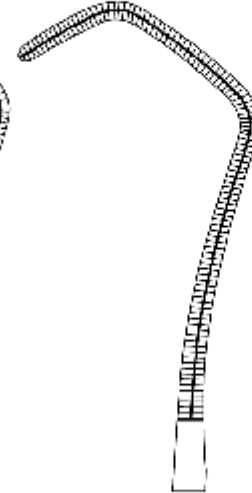

34.0550.18
18.0 cm



COOLEY

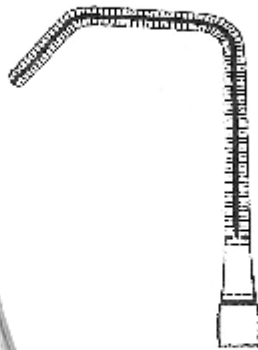

34.0560.01
16.5 cm

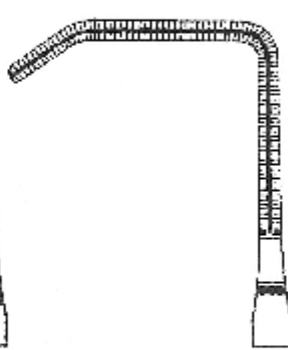

34.0560.02
16.5 cm

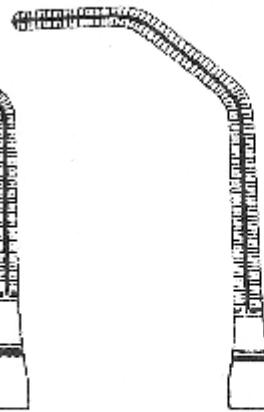

34.0560.03
17.5 cm

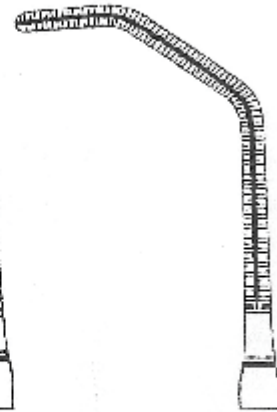

34.0560.04
17.5 cm

Atrauma Forceps
Atrauma Klemmen
Atrauma pinzas-clamps
Зажимы с атравматической нарезкой
非创伤性镊子



ALSO AVAILABLE IN TITANIUM

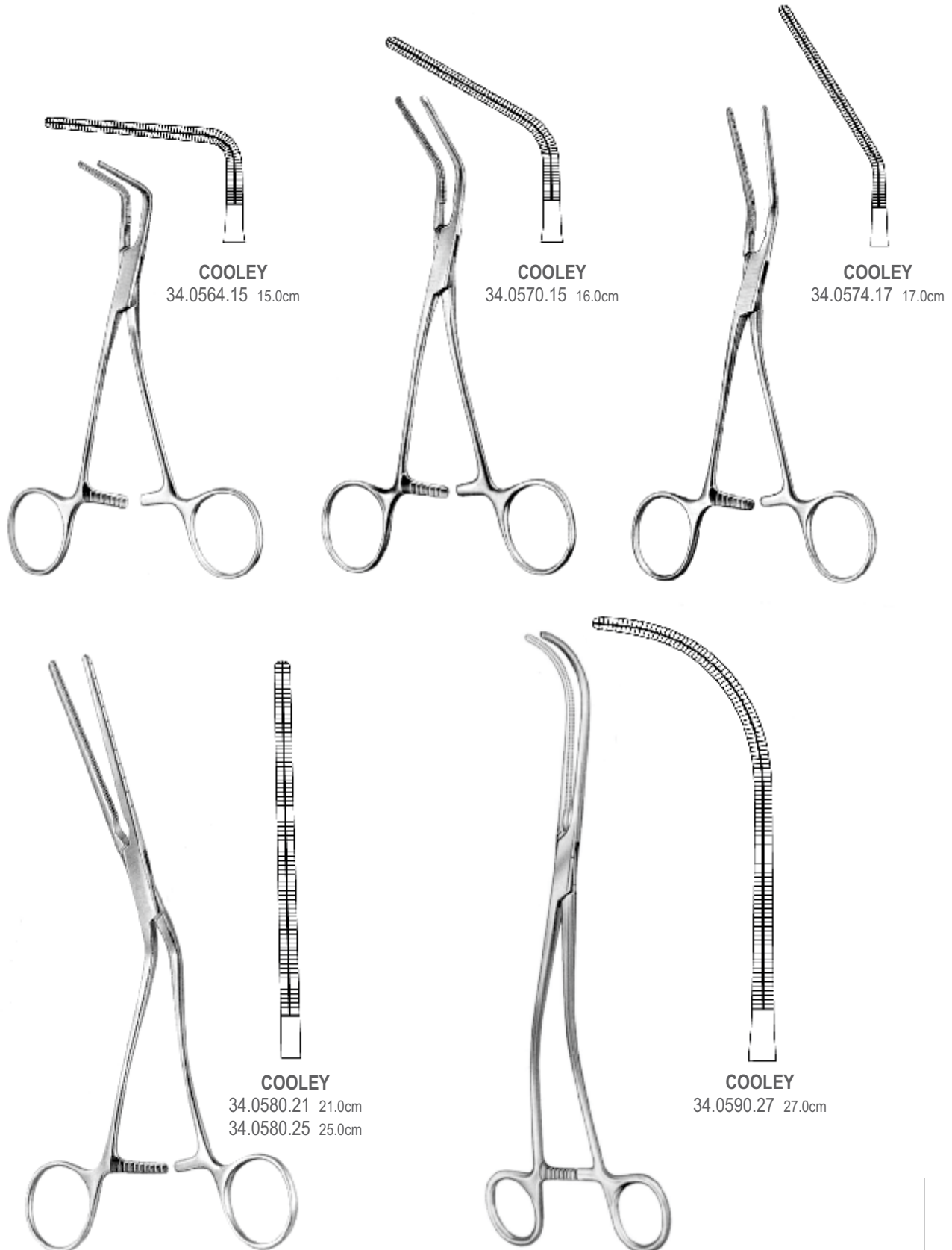

CARDIOVASCULAR

ALSO AVAILABLE IN TITANIUM

CARDIOVASCULAR

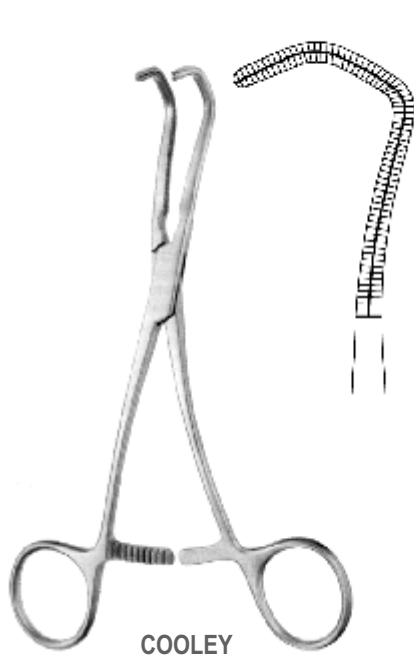

COOLEY
34.0594.17 17.0cm

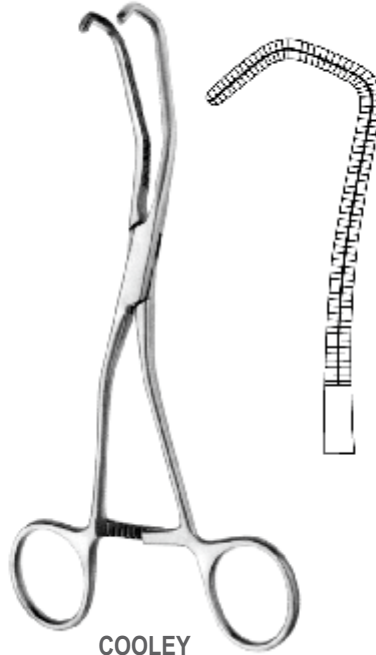

COOLEY
34.0596.17 17.0cm

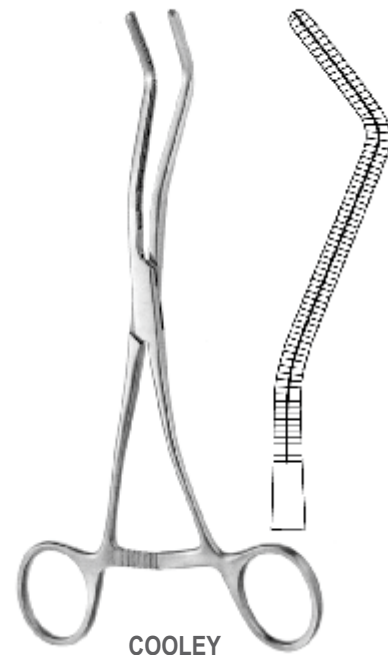

COOLEY
34.0600.18 18.0cm

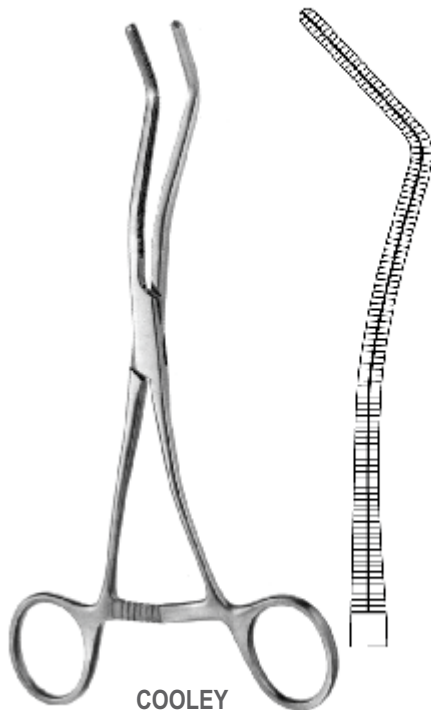

COOLEY
34.0602.19 19.0cm

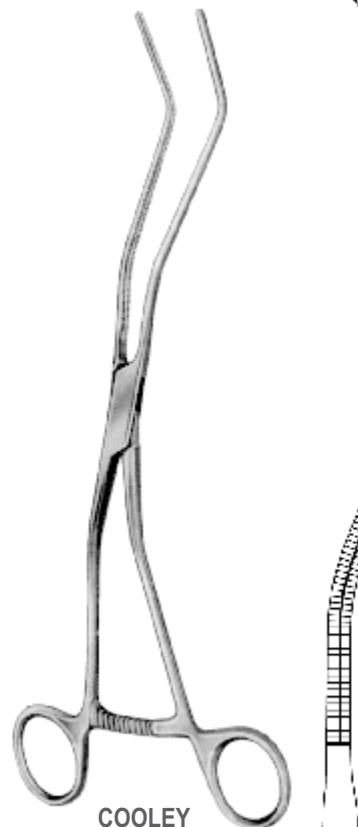

COOLEY
34.0604.26 26.0cm

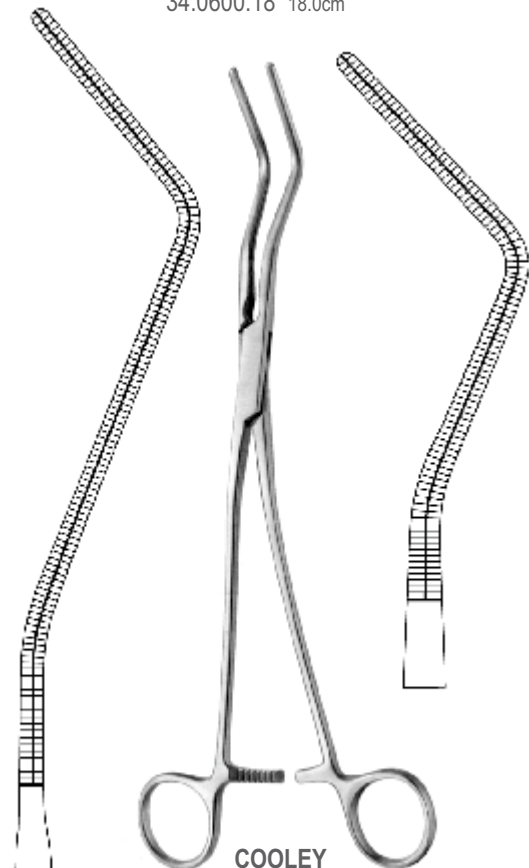

COOLEY
34.0606.27 27.0cm

Atrauma and Pediatric Clamps
Atrauma Neonatal-und Kinderklemmen
Atrauma pinzas clamps para recién nacidos y pediátricos
Зажимы с атравматической нарезкой, Зажимы детские
非创伤性和小儿夹



ALSO AVAILABLE IN TITANIUM

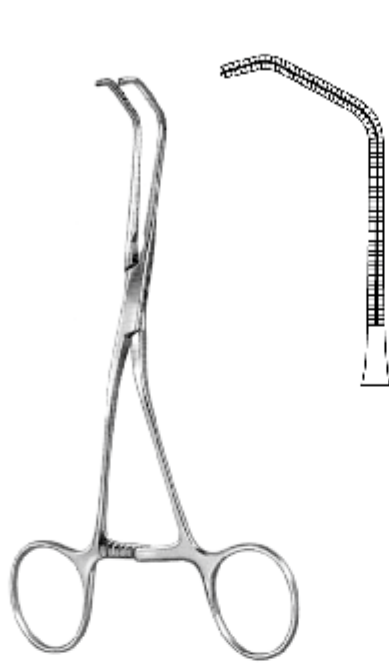

34.0610.15 15.0cm

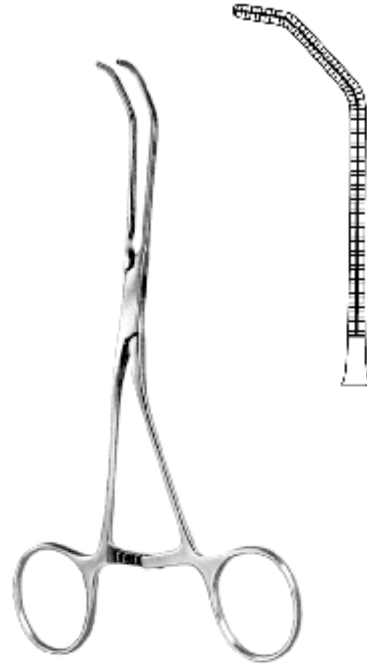

34.0614.15 15.5cm

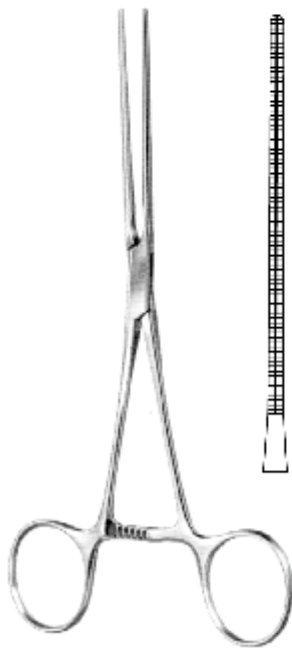

34.0620.16 16.5cm

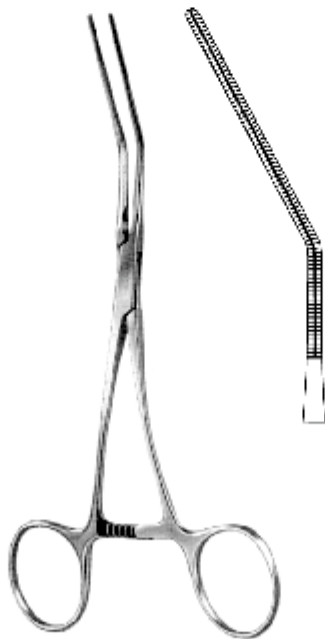

34.0622.16 16.0cm

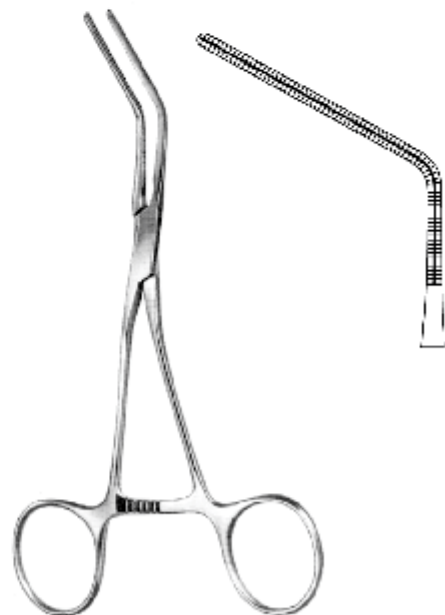

34.0624.15 15.0cm

CARDIOVASCULAR

ALSO AVAILABLE IN TITANIUM

CARDIOVASCULAR

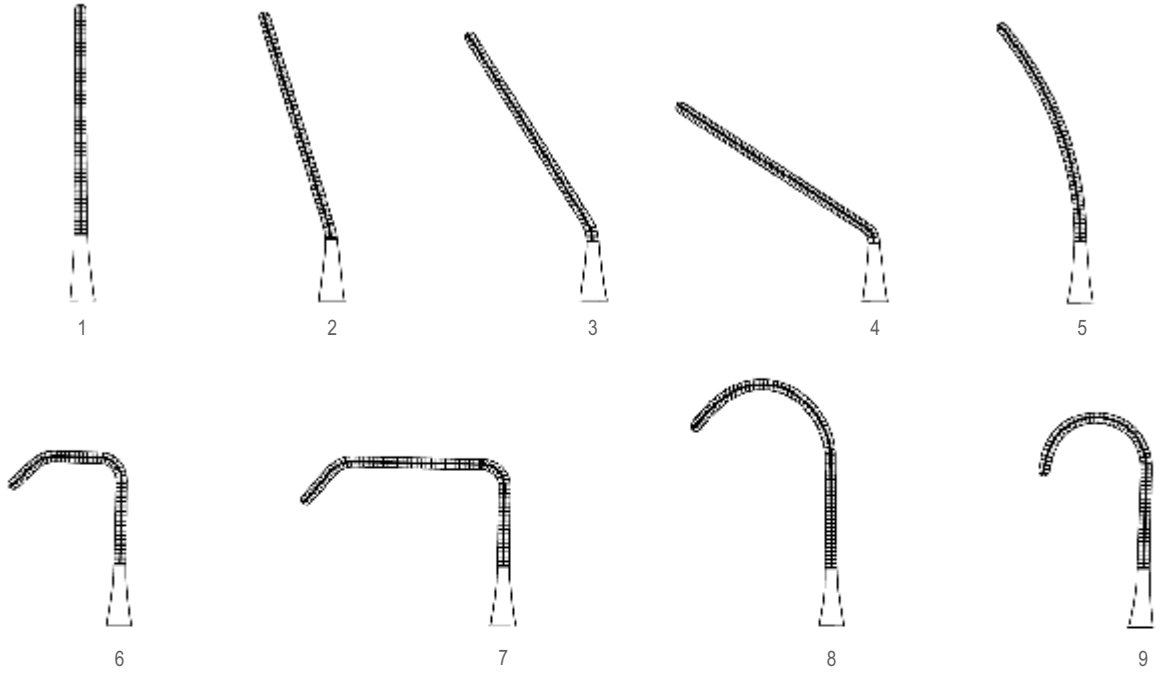

1 34.0630.01 14.5cm
 2 34.0630.02 14.5cm
 3 34.0630.03 14.5cm
 4 34.0630.04 13.5cm
 5 34.0630.05 14.0cm
 6 34.0630.06 13.5cm
 7 34.0630.07 13.5cm
 8 34.0630.08 14.0cm
 9 34.0630.09 13.5cm



1 34.0632.01 14.5cm
 2 34.0632.02 14.5cm
 3 34.0632.03 14.5cm
 4 34.0632.04 13.5cm
 5 34.0632.05 14.0cm
 6 34.0632.06 13.5cm
 7 34.0632.07 13.5cm
 8 34.0632.08 14.0cm
 9 34.0632.09 13.5cm



1 34.0634.01 14.5cm
 2 34.0634.02 14.5cm
 3 34.0634.03 14.5cm
 4 34.0634.04 13.5cm
 5 34.0634.05 14.0cm
 6 34.0634.06 13.5cm
 7 34.0634.07 13.5cm
 8 34.0634.08 14.0cm
 9 34.0634.09 13.5cm

Neonatal and Pediatric Clamps, Delicate Pattern
 Neonatal-und Kinderklemmen, Extrafeine Modelle
 Pinzas clamps para recién nacidos y pediátricos muy delicados
 Зажимы с атравматической нарезкой, Зажимы детские
 新生儿和儿科线夹，玲珑模式



ALSO AVAILABLE IN TITANIUM



34.0640.01
13.0cm

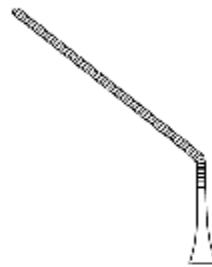

34.0640.02
13.0cm

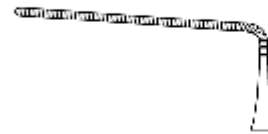

34.0640.03
11.0cm



CASTANEDA



34.0642.01
12.0cm



34.0642.02
12.0cm



34.0642.03
12.0cm



34.0642.04
12.0cm

CARDIOVASCULAR

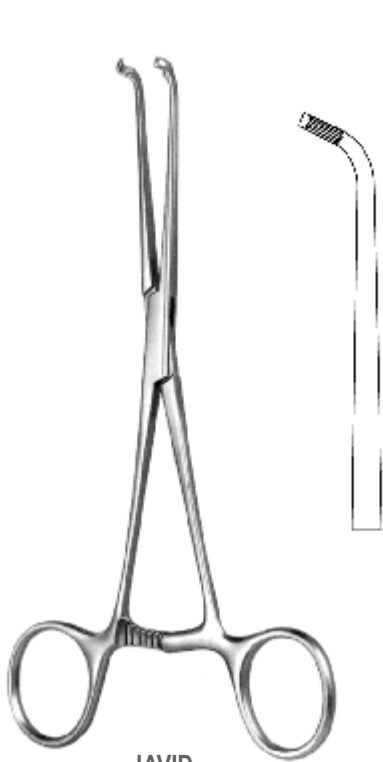

JAVID
34.0650.18 18.0cm

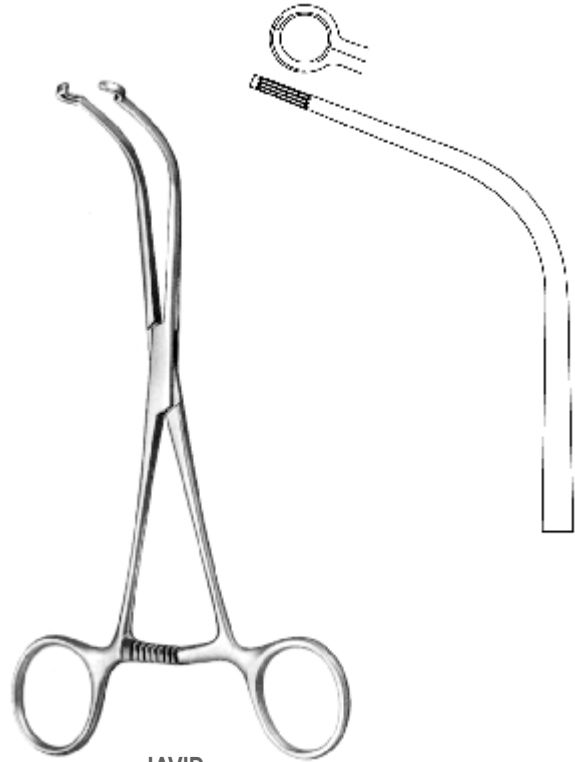

JAVID
34.0650.19 19.0cm

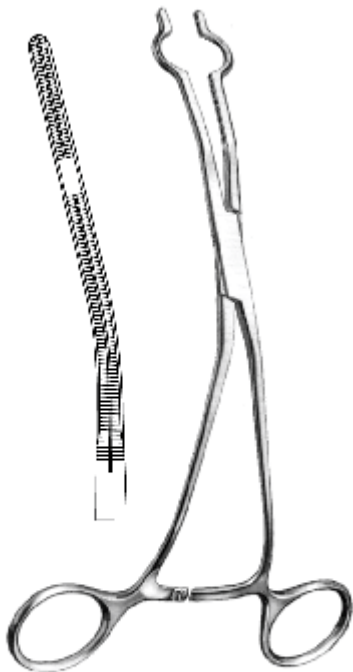

COOLEY

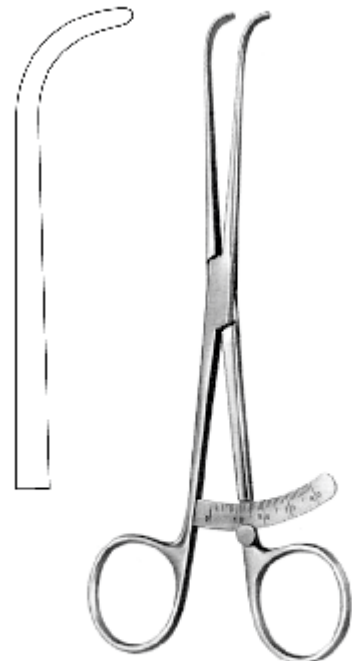
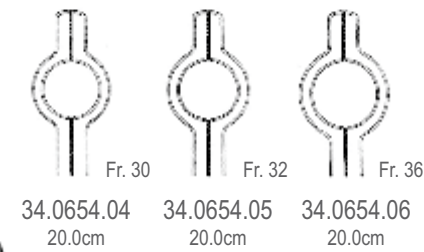
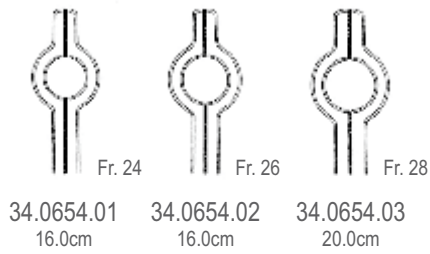

34.0660.18 18.0cm

Universal Clamps
Mehrzweckklemmen
Pinze universali
Зажимы с атравматической нарезкой, Зажимы универсальные
通用夹具



ALSO AVAILABLE IN TITANIUM

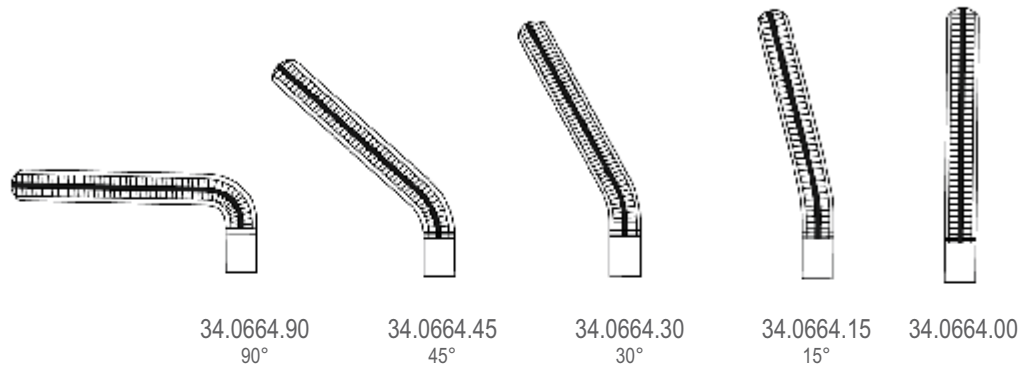

CARDIOVASCULAR



DARDIK

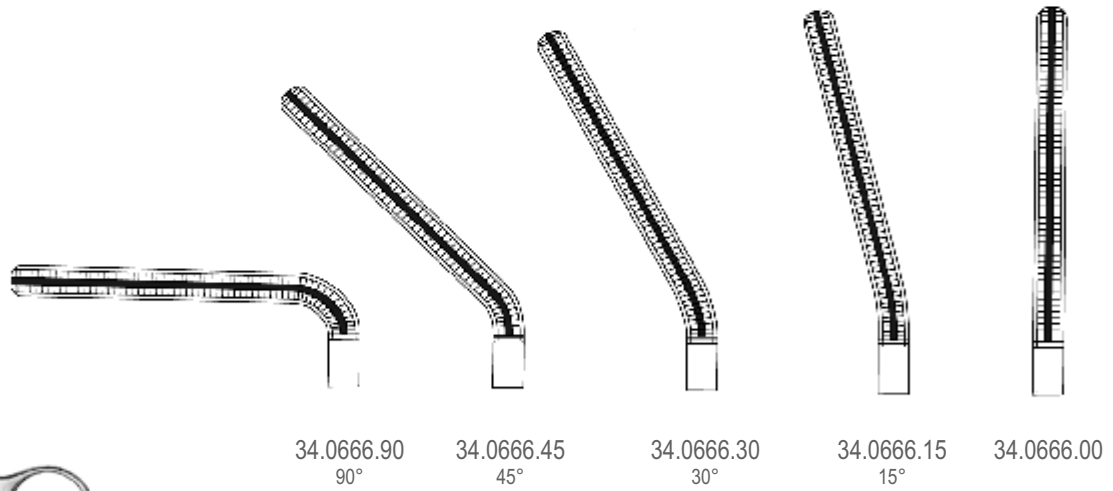

Blood Vessel Clamps

Clamps p/vasos

Gefäßklemmen

Зажимы сердечно-сосудистые, Зажимы для кровеносных сосудов

血管夹

CARDIOVASCULAR

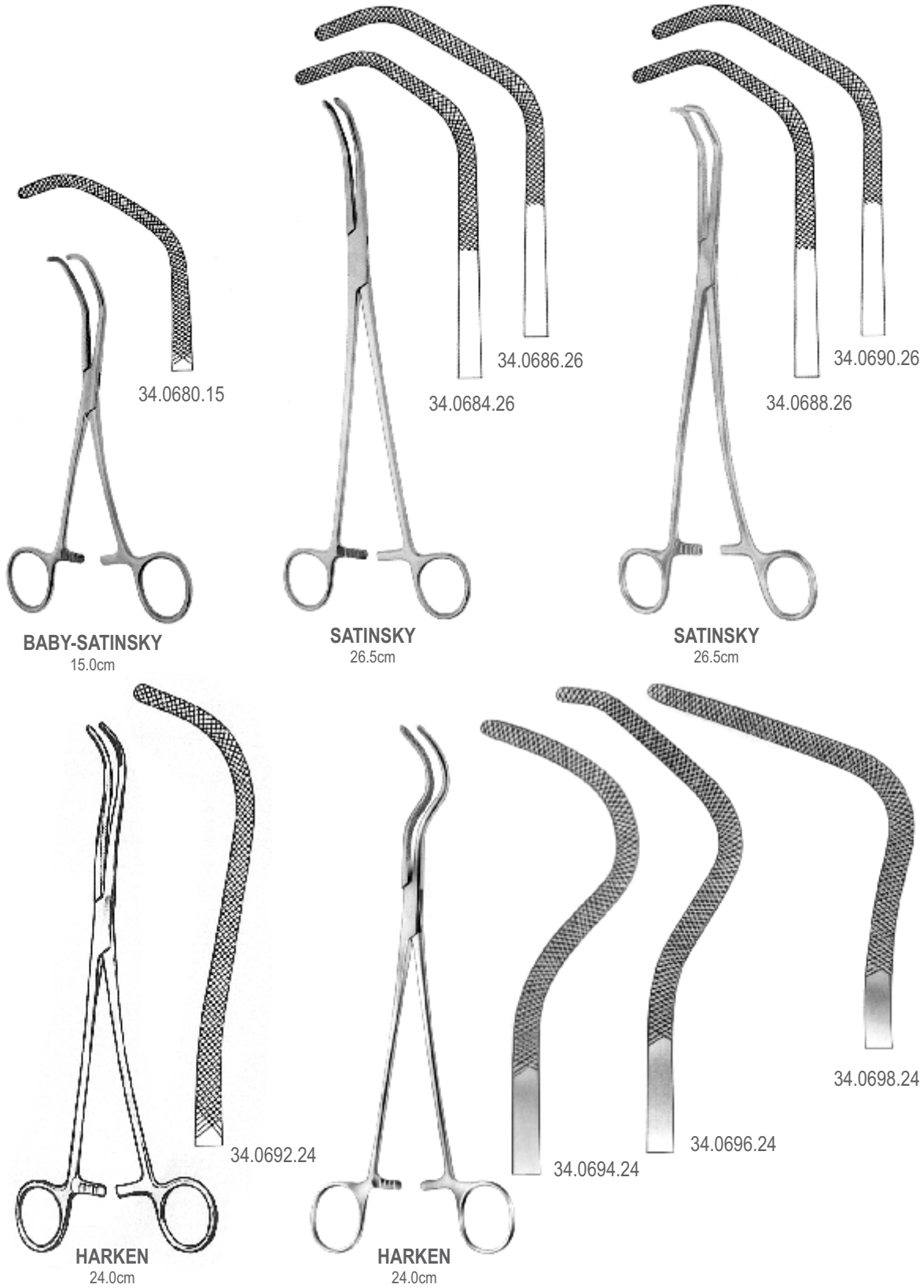

Lung Grasping Forceps, Aorta Clamps
 Pinzas-Clamps p/pulmón, Clamps aorta
 Lungenfasszangen, Aortaklemmen
 Зажимы для легкого, Зажимы для аорты
 龙抓钳, 主动脉夹



LOVELACE
 34.0710.20 20.0cm

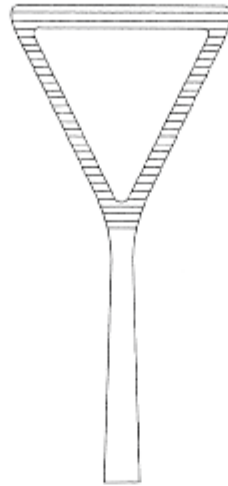

LOVELACE
 34.0711.20 20.0cm

CARDIOVASCULAR



BLALOCK

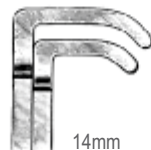

34.0720.14 15.0cm

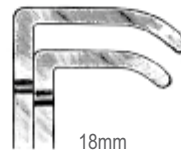

34.0722.18 20.0cm

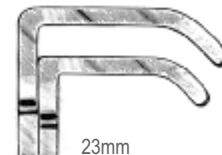

34.0722.23 20.0cm

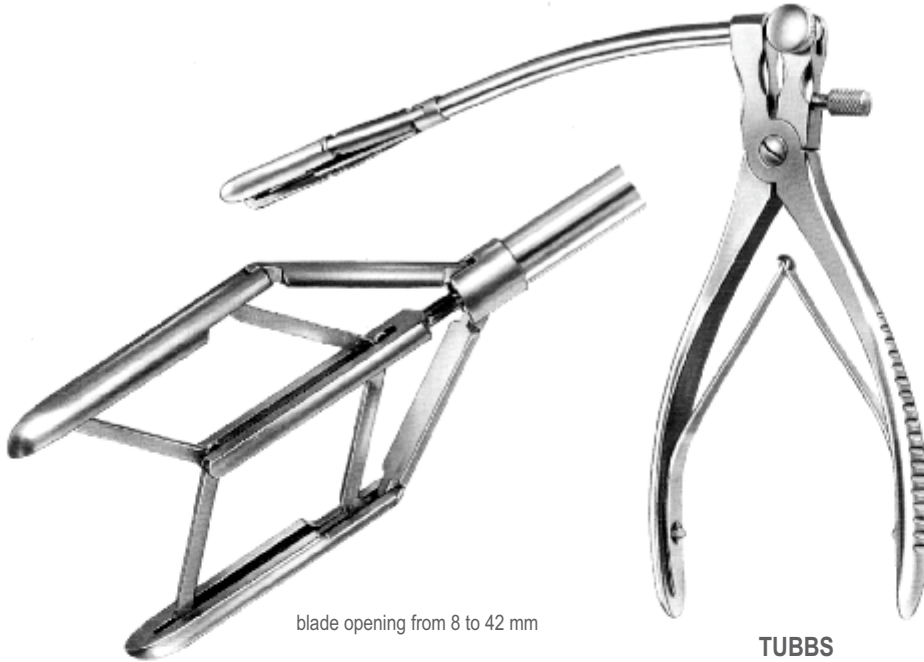

blade opening from 8 to 42 mm

TUBBS
34.0740.42

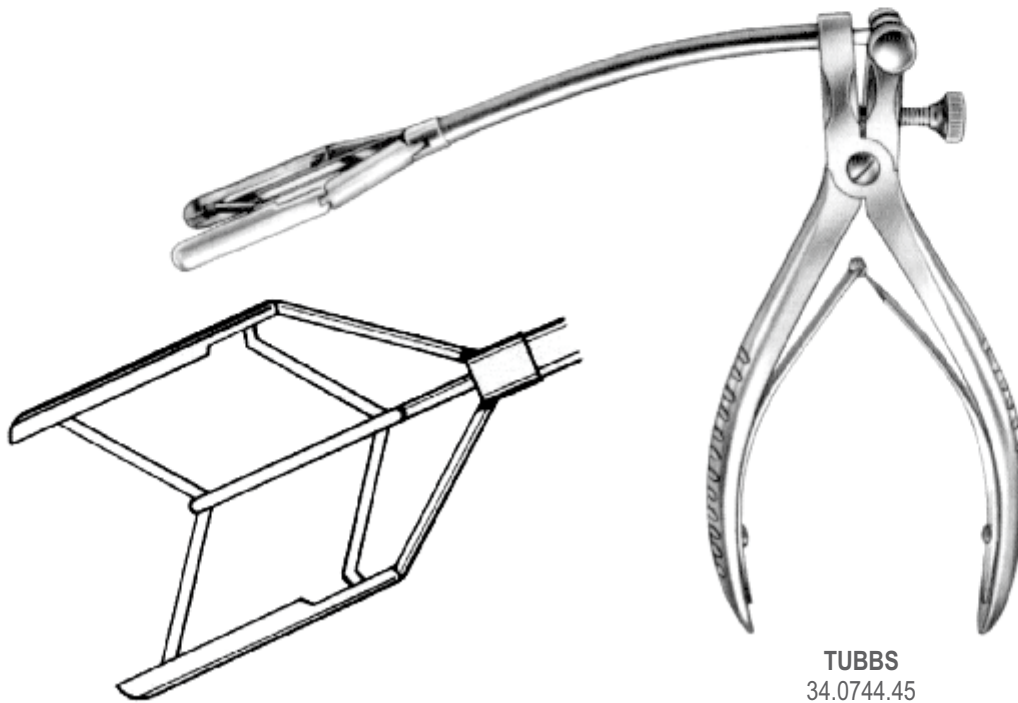

blade opening from 9 to 45 mm

TUBBS
34.0744.45

Vascular Dilators
Gefäß-Dilatatoren
Dilatadores vasculares
Расширители сосудистые
血管扩张器

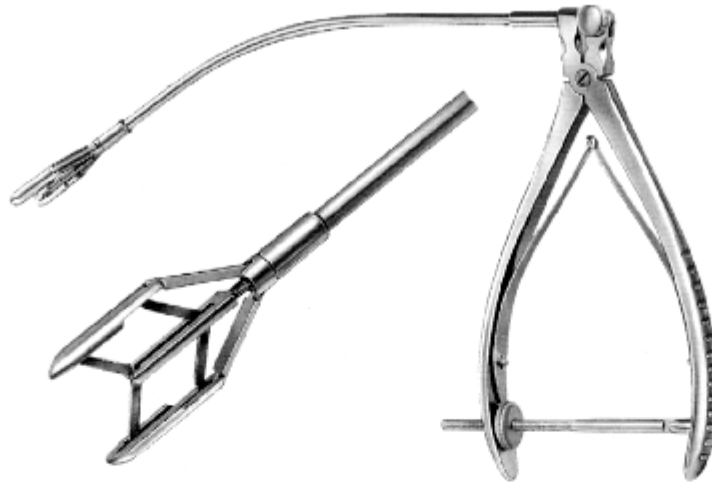

blade opening from 8 to 15 mm
blade opening from 8 to 45 mm

COOLEY
34.0750.15
34.0750.45

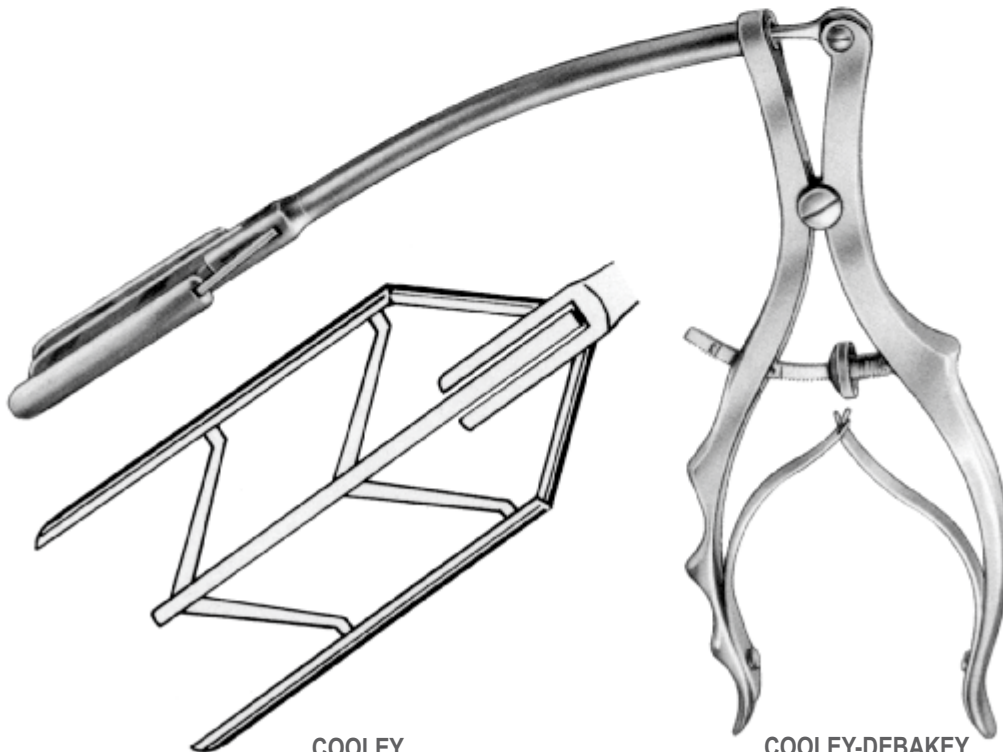

COOLEY
34.0754.40
blade opening 9 - 40mm

COOLEY-DEBAKEY
34.0756.30
blade opening 7 - 30mm

CARDIOVASCULAR

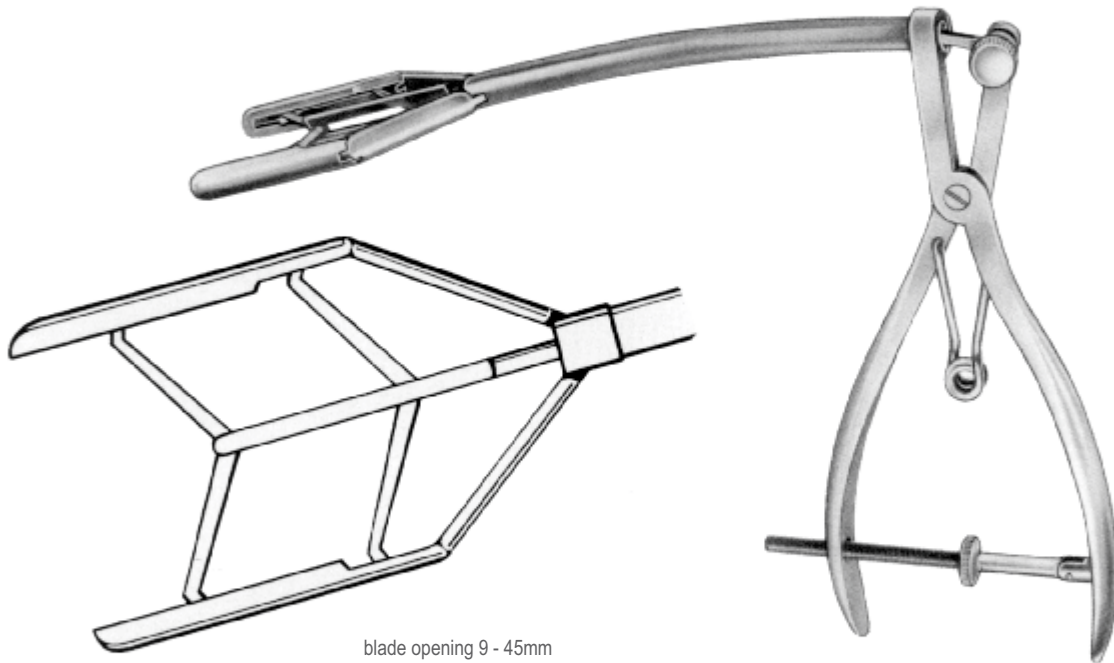

blade opening 9 - 45mm

GERBODE
34.0760.45

Mitral valve Dilators
Mitral ventil dilatoren
Dilatadores mitral de válvula
Расширители сосудистые
二尖瓣扩张器



Blade opening 4 - 10mm

HETZER
34.0770.10

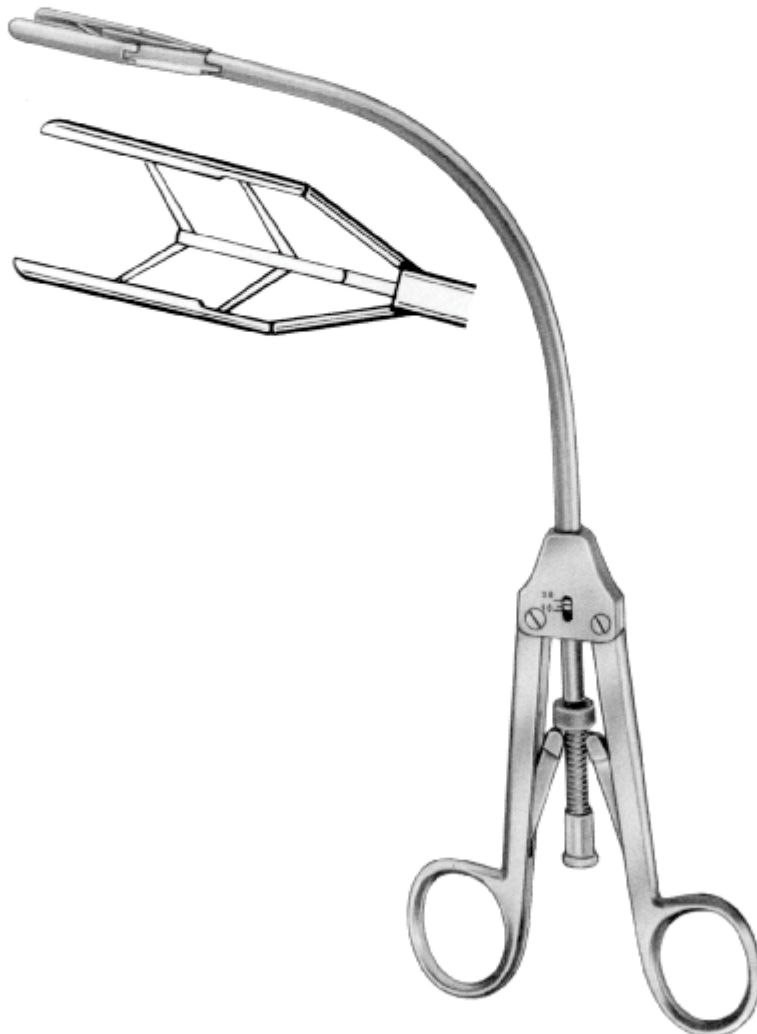

COOLEY blade opening
34.0776.18 5 - 18mm
34.0776.20 6 - 20mm

CARDIOVASCULAR

CARDIOVASCULAR



CRILE 20.0cm
 34.0780.01
 34.0780.02

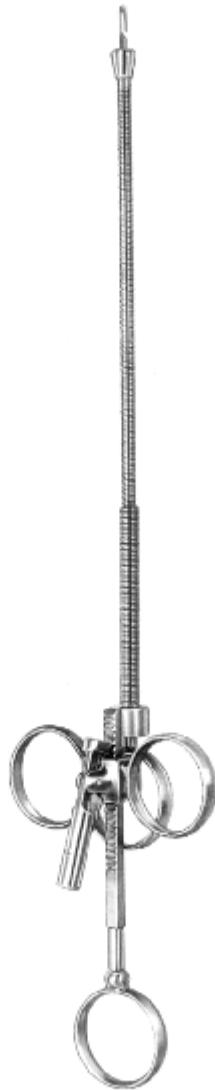

RUMEL-BELMONT 33.0cm
 34.0784.32 3.2mm Ø
 34.0784.64 6.4mm Ø



26.0cm



34.0786.15
 1.5mm

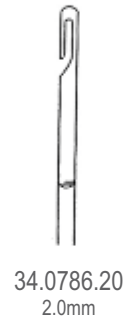

34.0786.20
 2.0mm



34.0786.25
 2.5mm



34.0786.30
 3.0mm



DE BAKEY
 34.0790.50 50.0cm

Endarterectomy Spatula and Dilators
 Endarteriektomie Spachtel und Dilatoren
 Espátula y dilatadores endarterectomia
 Шпатели эндерэктомические
 动脉内膜切除术锅铲和扩张器



CARDIOVASCULAR

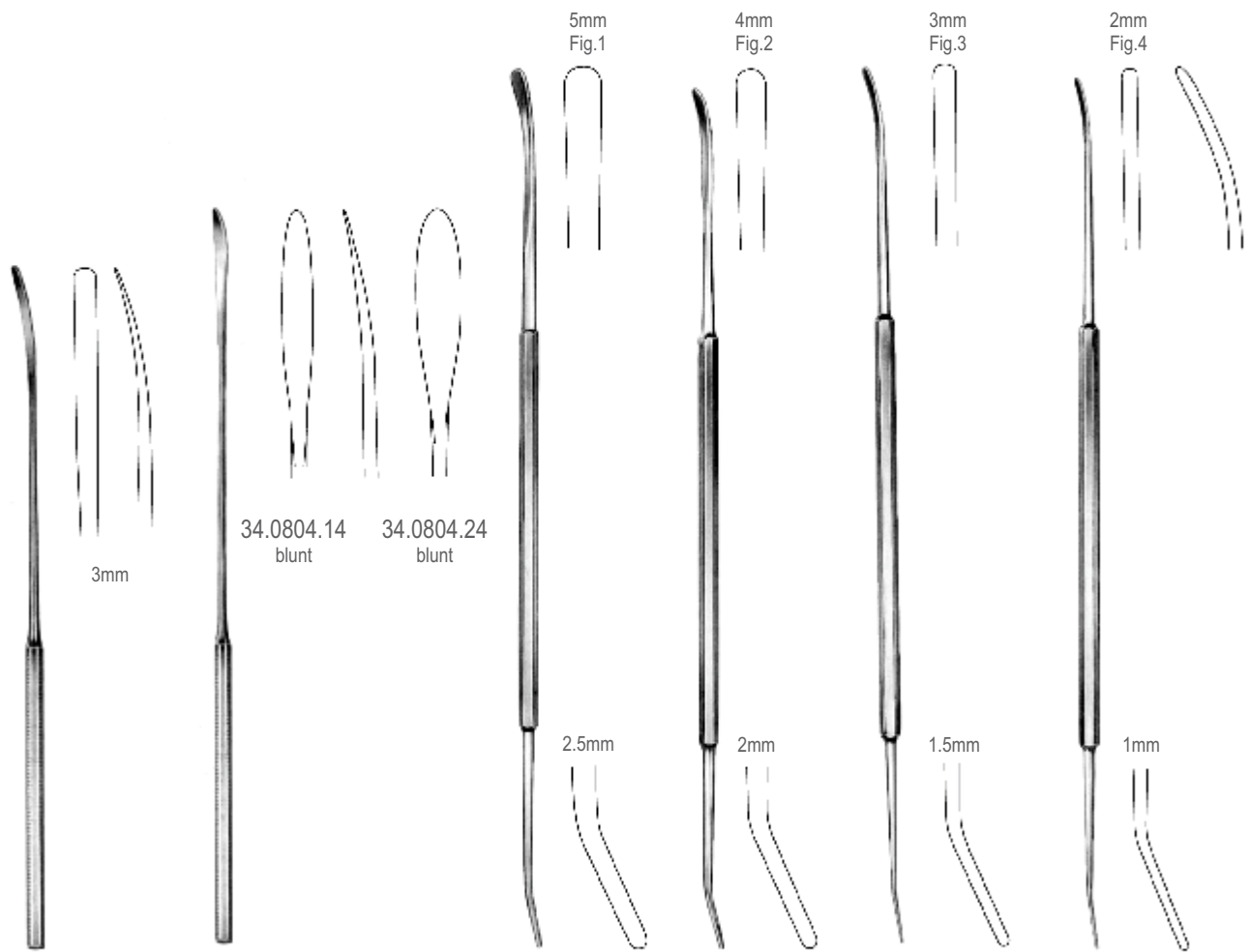

34.0800.18 18.5cm 34.0804.14 14.0cm
 34.0800.21 21.5cm 34.0804.24 23.5cm

ROBB
 34.0810.01
 24.0cm

ROBB
 34.0810.02
 24.0cm

ROBB
 34.0810.03
 24.0cm

ROBB
 34.0810.04
 24.0cm

CARDIOVASCULAR



COOLEY
13.0cm

34.0820.05 0.5mm Ø	34.0820.10 1.0mm Ø	34.0820.15 1.5mm Ø	34.0820.20 2.0mm Ø	34.0820.25 2.5mm Ø	34.0820.30 3.0mm Ø	34.0820.40 4.0mm Ø	34.0820.50 5.0mm Ø



DE BAKEY

19.0cm 34.0824.05 35.0cm 34.0828.05 0.5mm Ø	34.0824.10 34.0828.10 1mm Ø	34.0824.15 34.0828.15 1.5mm Ø	34.0824.20 34.0828.20 2mm Ø	34.0824.25 34.0828.25 2.5mm Ø	34.0824.30 34.0828.30 3mm Ø
19.0cm 34.0824.35 35.0cm 34.0828.35 3.5mm Ø	34.0824.40 34.0828.40 4mm Ø	34.0824.45 34.0828.45 4.5mm Ø	34.0824.50 34.0828.50 5mm Ø	34.0824.70 34.0828.70 7mm Ø	34.0824.90 34.0828.90 9mm Ø



SURGICAL
INSTRUMENTS



THE ULTIMATE CHOICE

Hilston
PREMIUM STAINLESS STEEL



THE ULTIMATE CHOICE

THORACIC & LUNG SURGERY

Thoracic and Lung Surgery
Brust und Lungenchirurgie
Cirugia toracico y pulmonar
ГРУДНАЯ И ЛЁГОЧНАЯ ХИРУРГИЯ
胸和肺外科

Bone and Rib Shears
Knochen-und Rippenscheren
Cizallas para huesos
Ножницы реберные
骨和肋骨剪

Hilton
PREMIUM STAINLESS STEEL



COLLIN
36.0010.19 19.0cm



STILLE
36.0020.21 21.0cm



GLUCK
36.0030.19 19.0cm
36.0030.22 22.0cm



36.0040.20 20.0cm
36.0040.23 23.0cm



36.0050.22 22.0cm



36.0060.17 17.0cm

THORACIC & LUNG SURGERY

Rib Shears, Sternum Scissors, Sternum Chisel
 Rippenscheren, Sternumschere, Sternummeißel
 Costotomos, tijera de esternon, cincel de esternon
 Ножницы реберные, Долота для грудины
 肋骨剪、胸骨剪、胸骨刀

THORACIC & LUNG SURGERY



GIERTZ -STILLE
36.0070.27 27.0cm



SAUERBRUCH - FREY
36.0080.36 36.0cm



BRUNNER
32.0cm
36.0090.28 right
36.0092.28 left



LEBSCHER
36.0100.24 24.5cm



LEBSCHER
36.0110.25 25.0cm



SAUERBRUCH
36.0120.26 26.0cm

Bone and Rib Shears
Knochen-und Rippenscheren
Cizallas para huesos
Ножницы реберные
骨和肋骨剪



36.0132.35 35.0cm

CORYLLOS
36.0130.35 35.0cm

BETHUNE
36.0140.34 34.0cm

DOYEN
36.0150.19 19.0cm

THORACIC & LUNG SURGERY



BETHUNE-NELSON
36.0160.34 34.0cm
with probe ended blades



ROBERTS
36.0170.34 34.0cm
with angular probe ended blades



ROBERTS
36.0180.34 34.0cm
with angular probe ended
blades of first and second ribs

Bone and Rib Shears
Knochen-und Rippenscheren
Cizallas para huesos
Ножницы реберные
骨和肋骨剪



SCHUMACHER
36.0190.21 21.0cm



TUDOR EDWARDS
36.0200.23 23.0cm

THORACIC & LUNG SURGERY

Scheme of dimensions

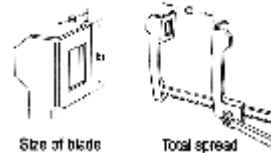

CASTAÑEDA

S/S	ALU	a	b	c
36.0300.01	36.7300.01	10.5mm	32mm	65mm
36.0300.02	36.7300.02	16mm	30mm	65mm



CASTAÑEDA

S/S	ALU	a	b	c
36.0302.01	36.7302.01	12mm	45mm	70mm



CASTAÑEDA

S/S	ALU	a	b	c
36.0304.01	36.7304.01	15mm	60mm	120mm

Rib Spreaders
 Rippensperrer
 Separadores
 Ранорасширители реберные
 胸骨牵开器



Schema of dimensions

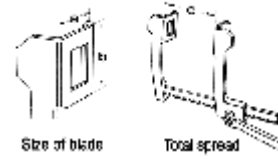

COOLEY

S/S	ALU	a	b	c
36.0310.01	36.7310.01	12mm	13mm	95mm
36.0310.02	36.7310.02	12mm	17mm	75mm
36.0310.03	36.7310.03	14mm	16mm	85mm



COOLEY

S/S	ALU	a	b	c
36.0312.01	36.7312.01	15mm	30mm	115mm
36.0312.02	36.7312.02	15mm	30mm	140mm
36.0312.03	36.7312.03	16mm	30mm	105mm
36.0312.04	36.7312.04	20mm	45mm	140mm
36.0312.05	36.7312.05	21mm	44mm	150mm
36.0312.06	36.7312.06	30mm	35mm	140mm



COOLEY

S/S	ALU	a	b	c
36.0314.01	36.7314.01	30mm	50mm	185mm
36.0314.02	36.7314.02	35mm	50mm	200mm
36.0314.03	36.7314.03	37mm	49mm	200mm

THORACIC & LUNG SURGERY

Scheme of dimensions

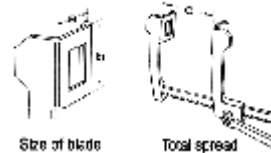

THORACIC & LUNG SURGERY



COOLEY

for neonatal

S/S	ALU	a	b	c
36.0320.01	36.7320.01	12mm	15mm	70mm

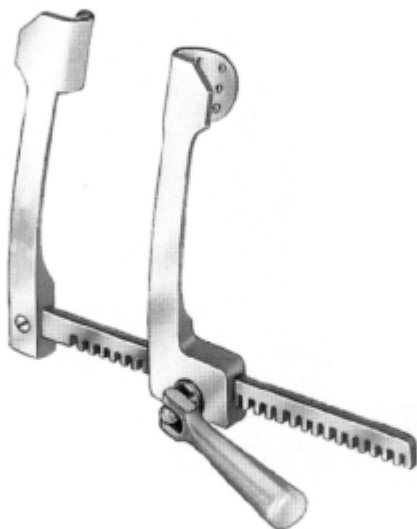

COOLEY

infant, sternal spreader

S/S	ALU	a	b	c
36.0322.01	36.7322.01	15mm	20mm	100mm



COOLEY

for babies

S/S	ALU	a	b	c
36.0330.01	36.7330.01	20mm	25mm	100mm

Rib Spreaders
 Rippensperrer
 Separadores
 Ранорасширители реберные
 胸骨牵开器

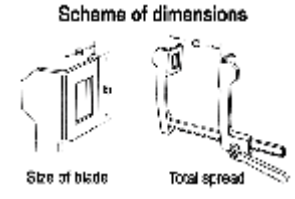
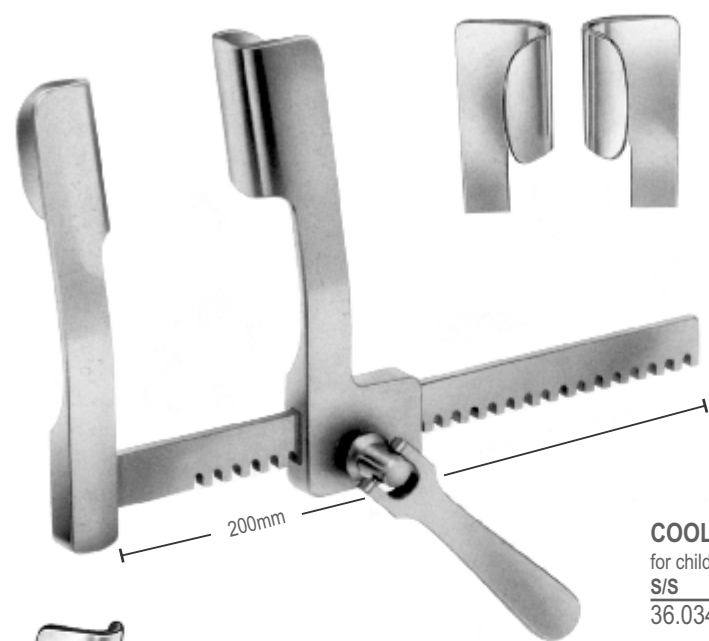

COOLEY
for children

S/S	ALU	a	b	c
36.0340.01	36.7340.01	21mm	45mm	145mm

for adult

36.0340.02	36.7340.02	32mm	50mm	190mm
------------	------------	------	------	-------



COOLEY
for children

S/S	ALU	a	b	c
36.0350.01	36.7350.01	35mm	100mm	180mm

for adult

36.0350.02	36.7350.02	35mm	115mm	230mm
------------	------------	------	-------	-------



COOLEY
for adults with suture separator

S/S	ALU	a	b	c
36.0360.01	36.7360.01	35mm	100mm	180mm

THORACIC & LUNG SURGERY

Scheme of dimensions

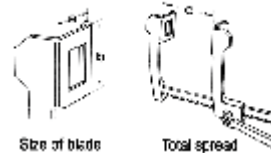

H-COOLEY

with swivel convex blades, for babies

S/S	ALU	a	b	c
36.0370.01	36.7370.01	10mm	15mm	90mm



H-COOLEY

with swivel blades, for babies

S/S	ALU	a	b	c
36.0370.02	36.7370.02	10mm	15mm	90mm

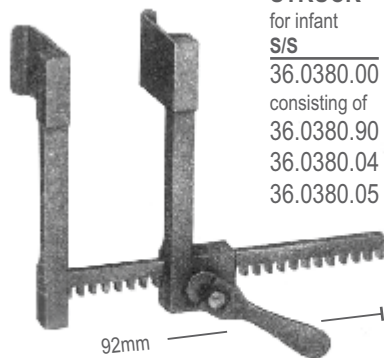

STRUCK

for infant

S/S

36.0380.00

consisting of

36.0380.90 spreader only

36.0380.04 1 pair

36.0380.05 1 pair

92mm

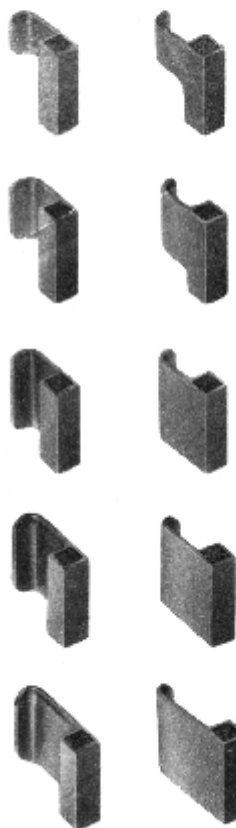

S/S blades only

36.0380.01
10x10mm

36.0380.02
10x15mm

36.0380.03
10x20mm

36.0380.04
15x20mm

36.0380.05
20x20mm

Rib Spreaders
 Rippensperrer
 Separadores
 Ранорасширители реберные
 胸骨牵开器



Scheme of dimensions

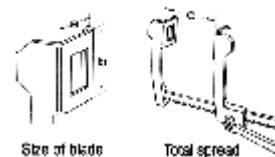

WEINBERG

for children

S/S	ALU	a	b	c
36.0390.01	36.7390.01	12mm	20mm	95mm

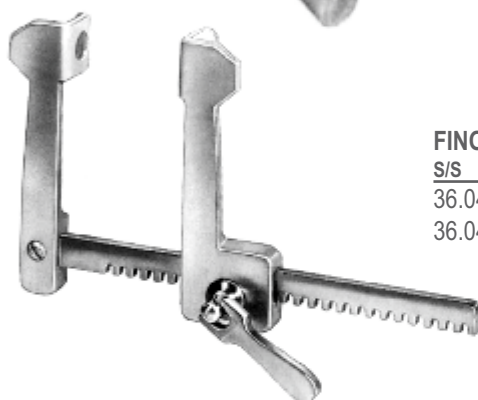

FINOCHIETTO-INFANT

S/S	ALU	a	b	c
36.0400.01	36.7400.01	12mm	15mm	70mm
36.0400.02	36.7400.02	15mm	15mm	75mm

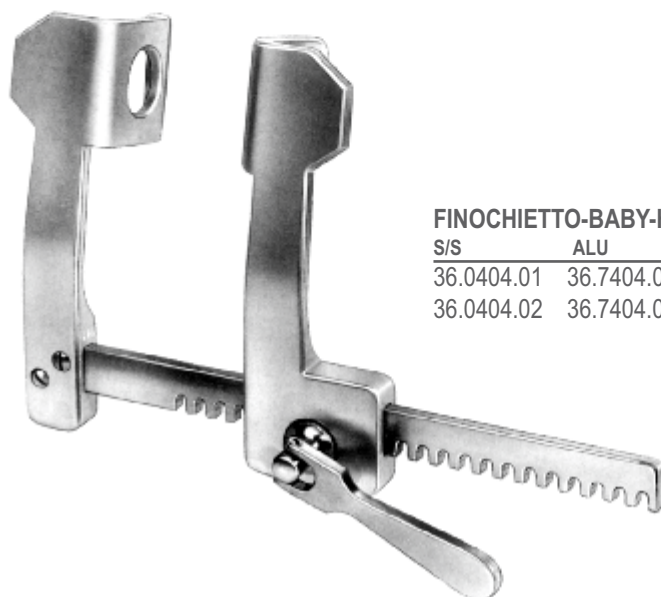

FINOCHIETTO-BABY-HAIGHT

S/S	ALU	a	b	c
36.0404.01	36.7404.01	27mm	30mm	95mm
36.0404.02	36.7404.02	31mm	31mm	100mm

THORACIC & LUNG SURGERY

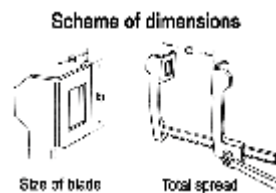
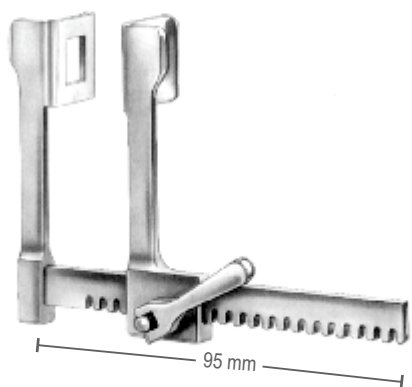

FINOCHIETTO-BABY

S/S	ALU	a	b	c
36.0410.01	36.7410.01	14mm	15mm	75mm
36.0410.02	36.7410.02	18mm	20mm	75mm

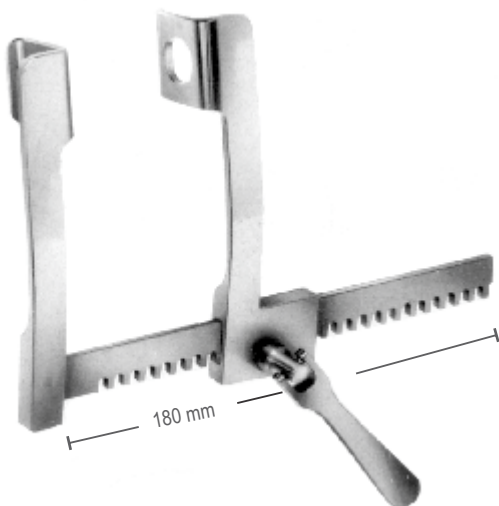

S/S	ALU	a	b	c
36.0420.01	36.7420.01	28mm	32mm	120mm



FINOCHIETTO

S/S	ALU	a	b	c
36.0430.01	36.7430.01	12mm	15mm	100mm
36.0430.02	36.7430.02	28mm	30mm	143mm
36.0430.03	36.7430.03	31mm	45mm	210mm
36.0430.04	36.7430.04	42mm	61mm	245mm
36.0430.05	36.7430.05	74mm	64mm	245mm

Rib Spreaders
 Rippensperrer
 Separadores
 Ранорасширители реберные
 胸骨牵开器



Scheme of dimensions

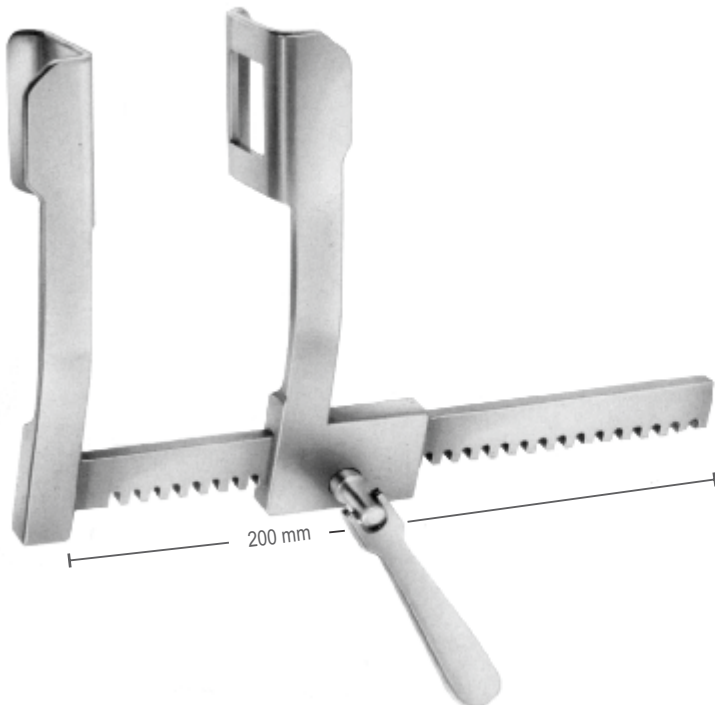
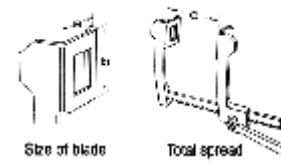

FINOCHIETTO

S/S	ALU	a	b	c
36.0440.01	36.7440.01	36mm	45mm	140mm

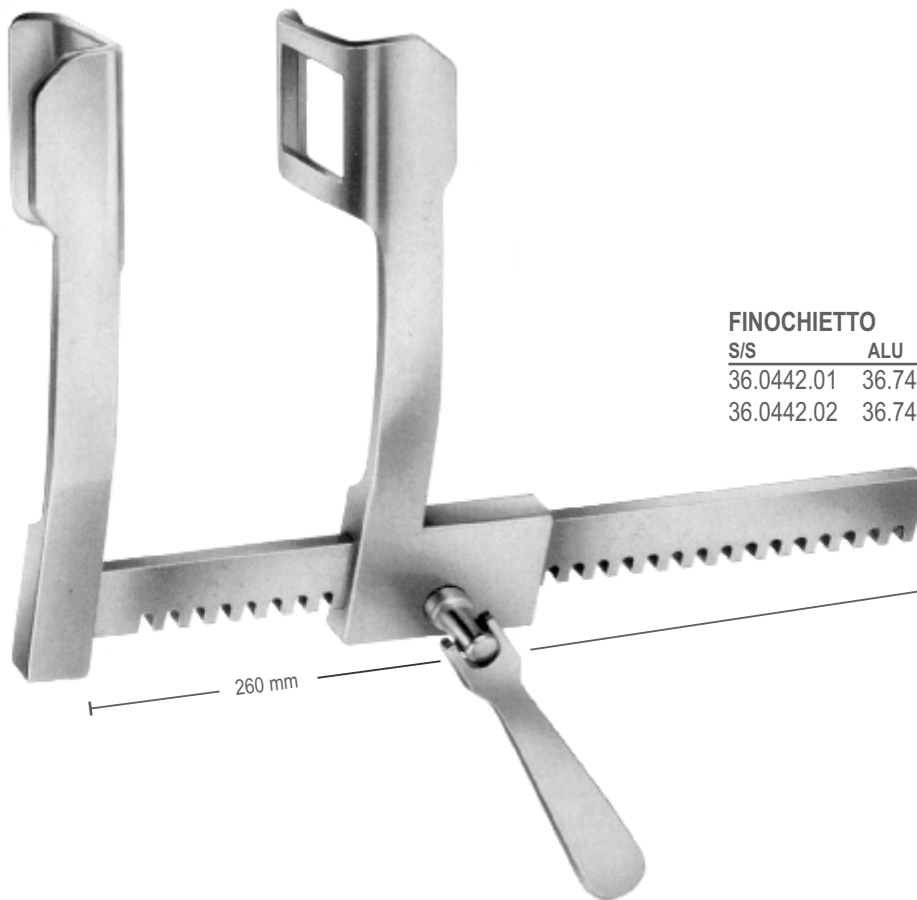

FINOCHIETTO

S/S	ALU	a	b	c
36.0442.01	36.7442.01	44mm	65mm	210mm
36.0442.02	36.7442.02	65mm	65mm	210mm

THORACIC & LUNG SURGERY

Scheme of dimensions

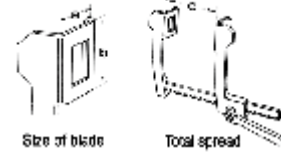

THORACIC & LUNG SURGERY

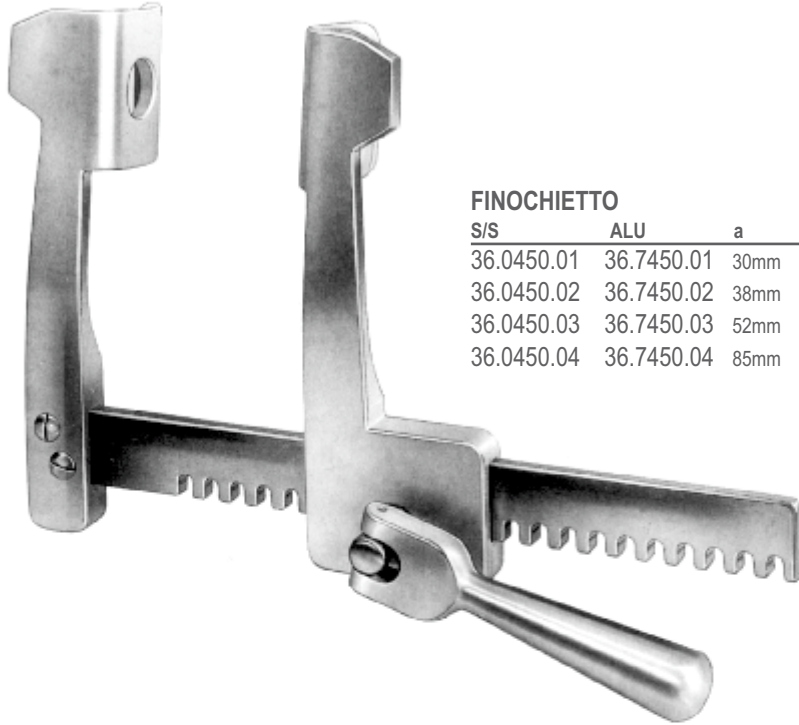

FINOCHIETTO

S/S	ALU	a	b	c
36.0450.01	36.7450.01	30mm	45mm	140mm
36.0450.02	36.7450.02	38mm	44mm	135mm
36.0450.03	36.7450.03	52mm	62mm	175mm
36.0450.04	36.7450.04	85mm	65mm	175mm

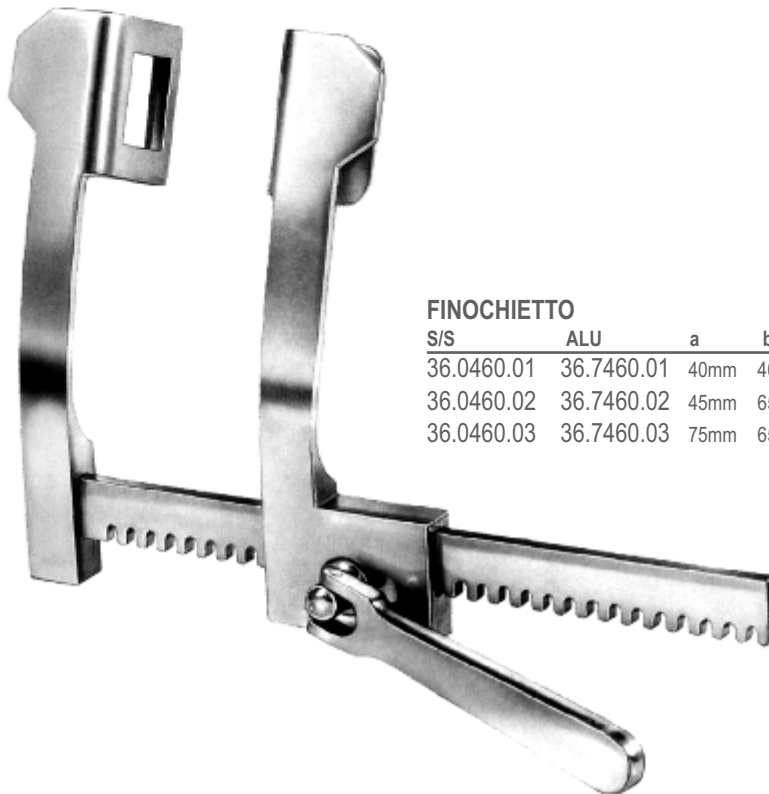

FINOCHIETTO

S/S	ALU	a	b	c
36.0460.01	36.7460.01	40mm	40mm	165mm
36.0460.02	36.7460.02	45mm	65mm	200mm
36.0460.03	36.7460.03	75mm	65mm	250mm

Rib Spreaders
 Rippensperrer
 Separadores
 Ранорасширители реберные
 胸骨牵开器

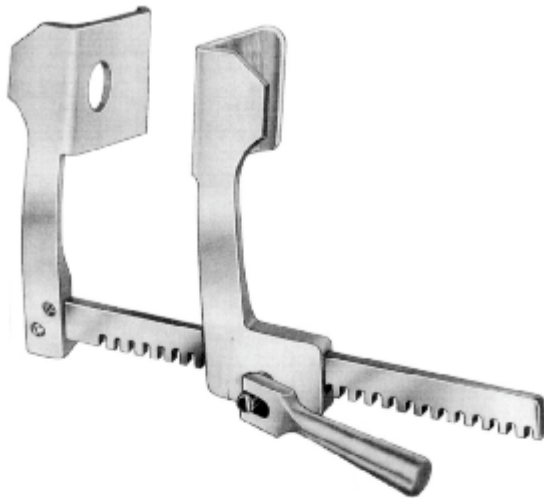

Scheme of dimensions

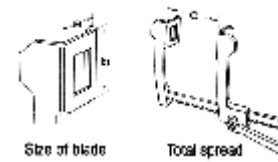

FINOCHIETTO

for adults

S/S	ALU	a	b	c
36.0470.01	36.7470.01	42mm	62mm	170mm
36.0470.02	36.7470.02	73mm	65mm	170mm



FINOCHIETTO

for adults, with suture separator

S/S	ALU	a	b	c
36.0472.01	36.7472.01	42mm	62mm	170mm



FINOCHIETTO

for adults, with 2 blades attached to each arm

S/S	ALU	a	b	c
36.0480.01	36.7480.01	10mm	15mm	120mm
36.0480.02	36.7480.02	14mm	14mm	120mm
36.0480.03	36.7480.03	14mm	20mm	120mm

THORACIC & LUNG SURGERY

Scheme of dimensions

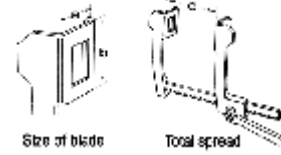

THORACIC & LUNG SURGERY

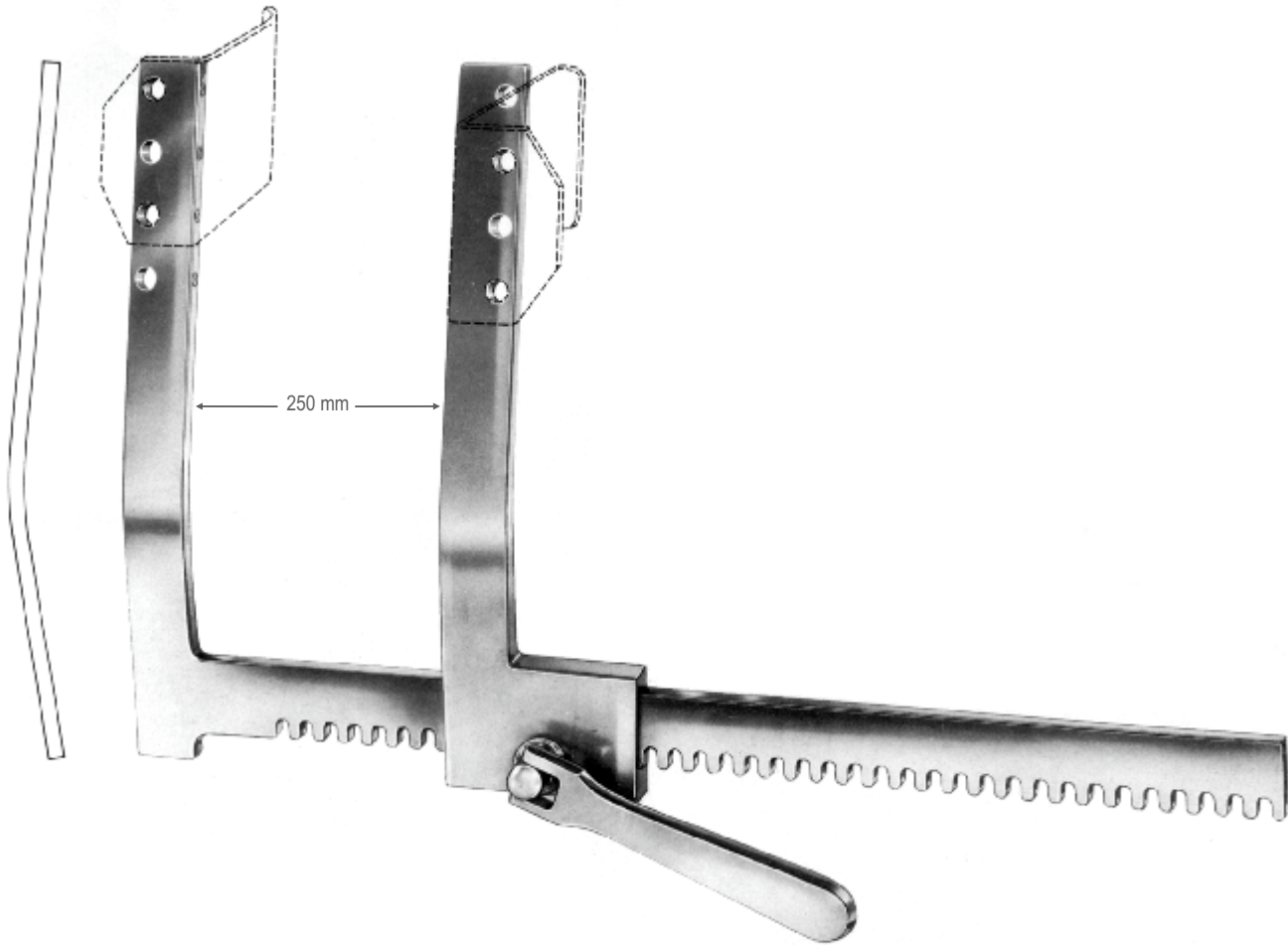

FINOCHIETTO

3 pairs of exchangeable blades

S/S	ALU
36.0490.00	36.7490.00
blades	
36.0490.30	36.7490.30
36.0490.40	36.7490.40
36.0490.50	36.7490.50
frame only 150mm	
36.0490.01	36.7490.01

S/S	ALU
36.0491.00	36.7491.00
blades	
36.0491.40	36.7491.40
36.0491.50	36.7491.50
36.0491.60	36.7491.60
frame only 250mm	
36.0491.01	36.7491.01

Interchangeable Blades

Wechselven

valves intercambiables

Ранорасширители реберные, Зеркала сменные к ранорасширителям

可换刀片

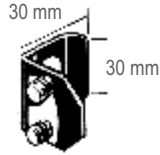

S/S Alu
36.0490.30 36.7490.30
30x30mm

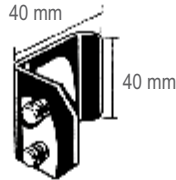

S/S Alu
36.0490.40 36.7490.40
40x40mm

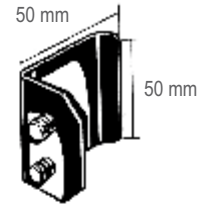

S/S Alu
36.0490.50 36.7490.50
50x50mm

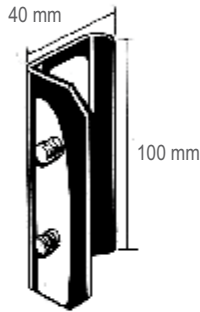

S/S Alu
36.0491.40 36.7491.40
40x100mm

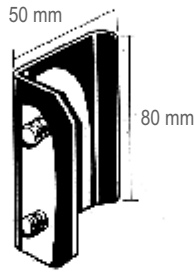

S/S Alu
36.0491.50 36.7491.50
50x80mm

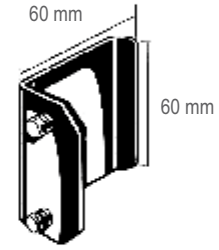

S/S Alu
36.0491.60 36.7491.60
60x60mm

Optional Exchangeable Blades

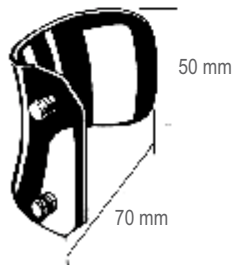

S/S Alu
36.0491.70 36.7491.70
70x50mm

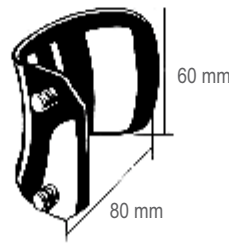

S/S Alu
36.0491.80 36.7491.80
80x60mm

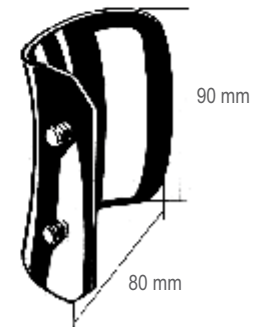

S/S Alu
36.0491.90 36.7491.90
80x90mm

THORACIC & LUNG SURGERY

Scheme of dimensions

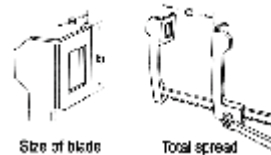

BURFORD

for children
with 2 pairs of blades

S/S	ALU	a	b	c
36.0500.01	36.7500.01	30mm 41mm	42mm 42mm	130mm
36.0500.02	36.7500.02	34mm 48mm	42mm 42mm	135mm



BURFORD

for adults
with 2 pairs of blades

S/S	ALU	a	b	c
36.0502.01	36.7502.01	47mm 65mm	62mm 62mm	200mm
36.0502.02	36.7502.02	47mm 65mm	62mm 62mm	260mm
36.0502.03	36.7502.03	47mm 65mm	62mm 62mm	300mm

Rib Spreaders
 Rippensperrer
 Separadores
 Ранорасширители реберные
 胸骨牵开器



Scheme of dimensions

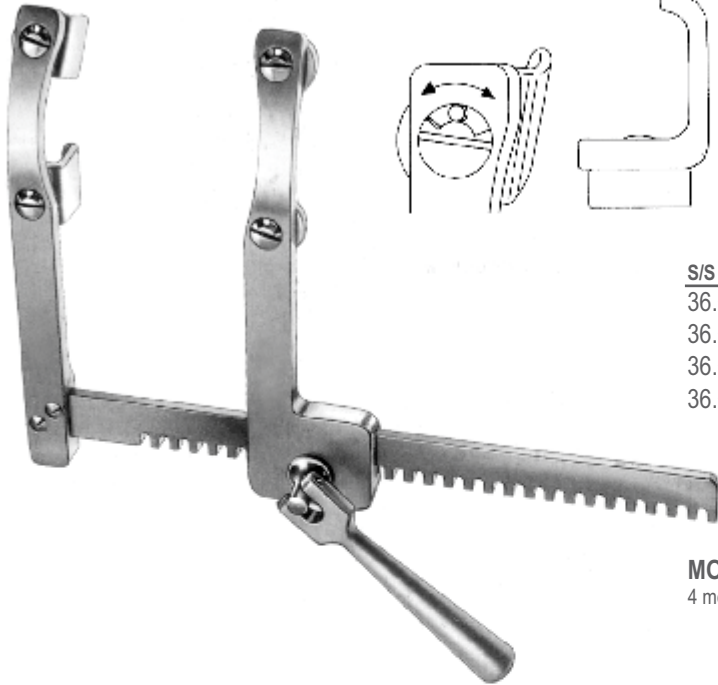
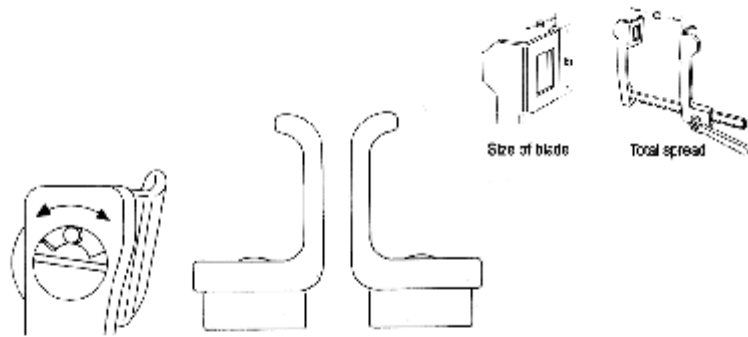

S/S	ALU	a	b	c
36.0510.01	36.7510.01	12mm	20mm	155mm
36.0510.02	36.7510.02	20mm	20mm	155mm
36.0510.03	36.7510.03	40mm	20mm	155mm
36.0510.04	36.7510.04	17mm	22mm	160mm

MORSE-FAVALORO
 4 movable blades for children

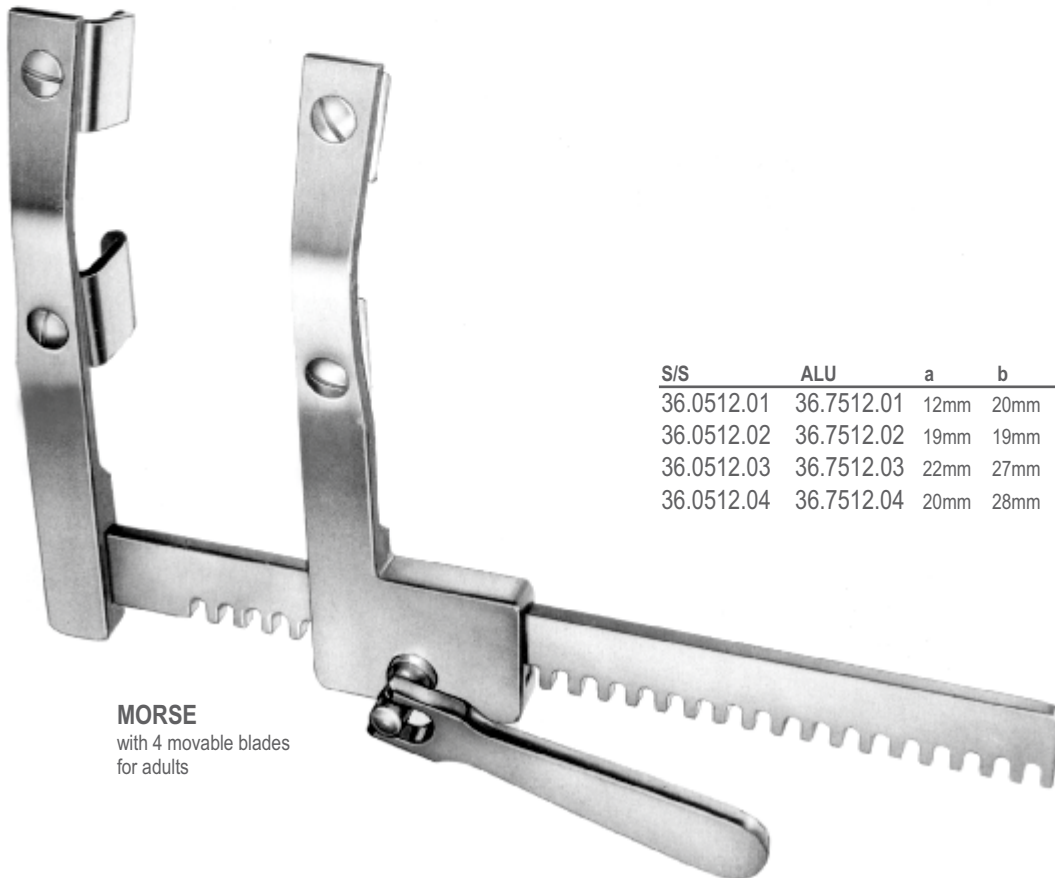

MORSE
 with 4 movable blades
 for adults

S/S	ALU	a	b	c
36.0512.01	36.7512.01	12mm	20mm	200mm
36.0512.02	36.7512.02	19mm	19mm	200mm
36.0512.03	36.7512.03	22mm	27mm	200mm
36.0512.04	36.7512.04	20mm	28mm	210mm

THORACIC & LUNG SURGERY

Scheme of dimensions

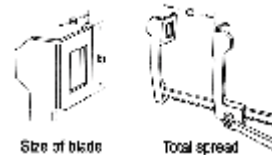

MORSE STERNAL

S/S	ALU	a	b	c
36.0520.01	36.7520.01	30mm	35mm	200mm

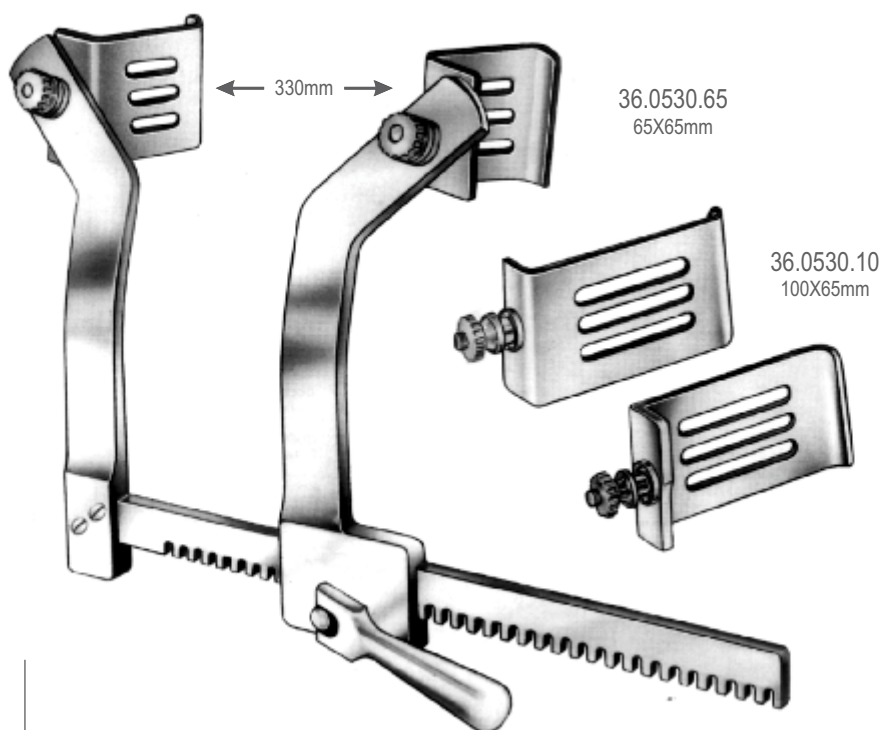

BRAASTAD

S/S	ALU
36.0530.01	36.7530.01
with 2 pairs of blades	
36.0530.65	36.7530.65
36.0530.10	36.7530.10

Rib Spreaders
 Rippensperrer
 Separadores
 Ранорасширители реберные
 胸骨牵开器

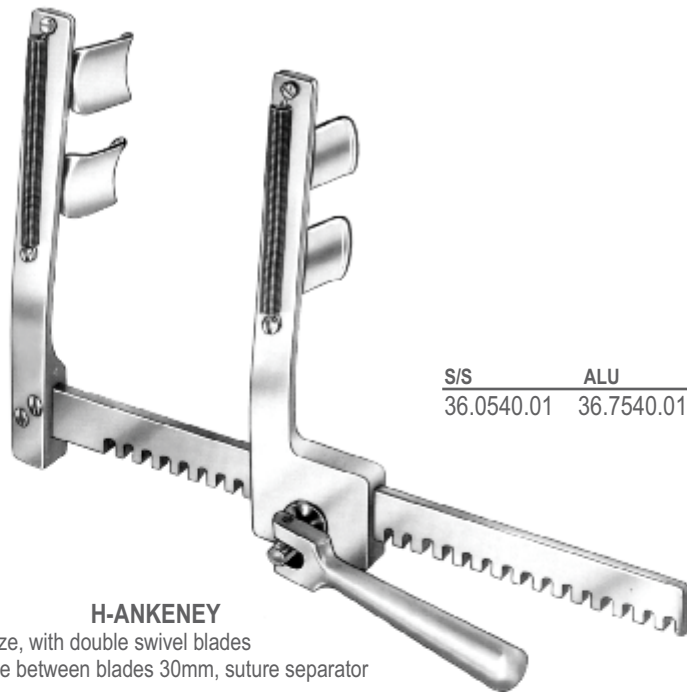

Scheme of dimensions

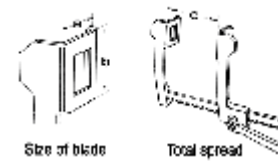

S/S	ALU	a	b	c
36.0540.01	36.7540.01	20mm	20mm	160mm

H-ANKENEY
 child size, with double swivel blades
 distance between blades 30mm, suture separator

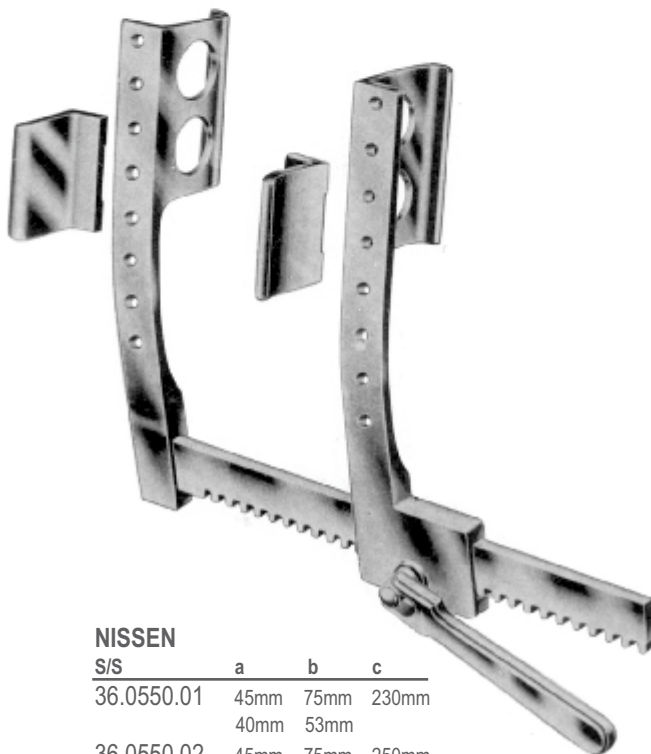

NISSEN				
S/S	a	b	c	
36.0550.01	45mm	75mm	230mm	
	40mm	53mm		
36.0550.02	45mm	75mm	250mm	
	40mm	53mm		

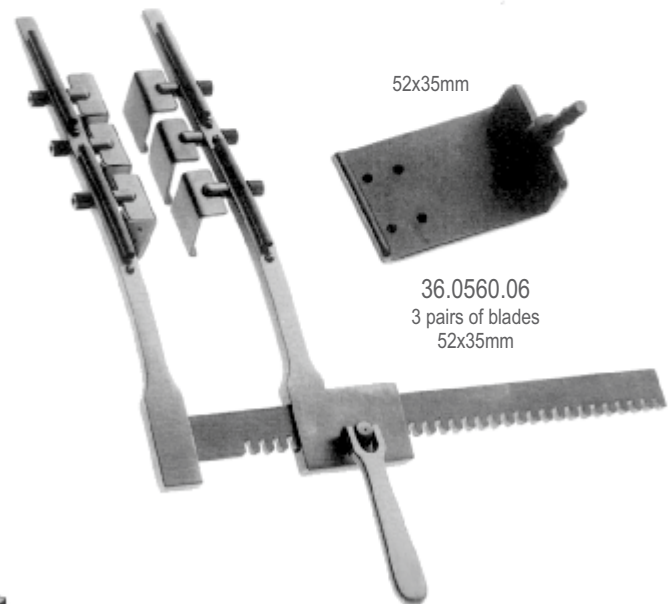

ANKENEY				
S/S	a	b	c	
36.0560.01	52mm	35mm	178mm	

52x35mm

36.0560.06
 3 pairs of blades
 52x35mm

THORACIC & LUNG SURGERY

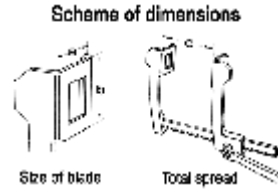
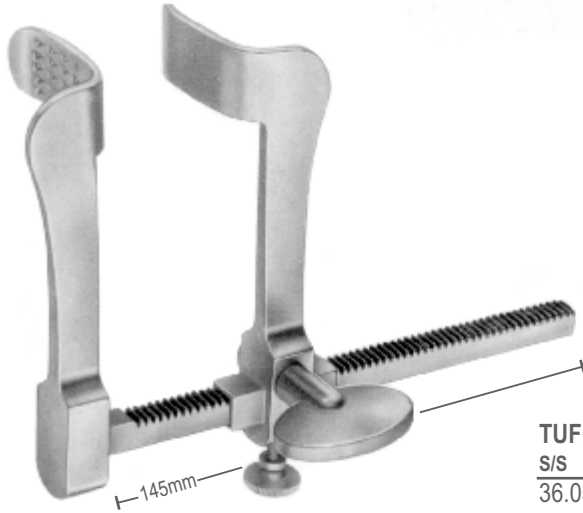

TUFFIER

S/S	a	b	c
36.0570.14	32mm	19mm	110mm

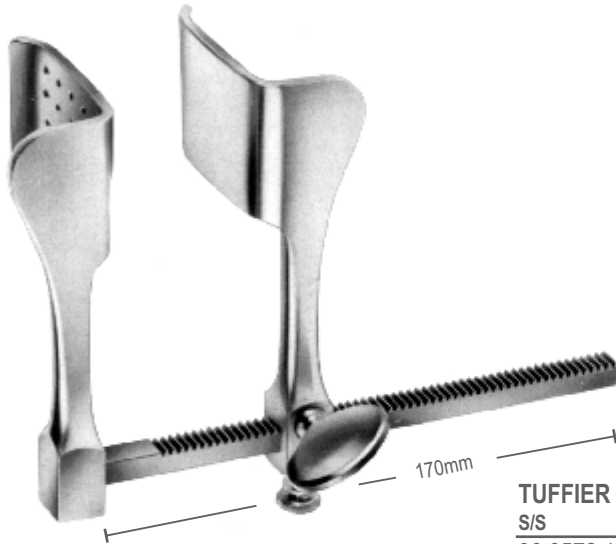

TUFFIER

S/S	a	b	c
36.0572.17	43mm	53mm	130mm

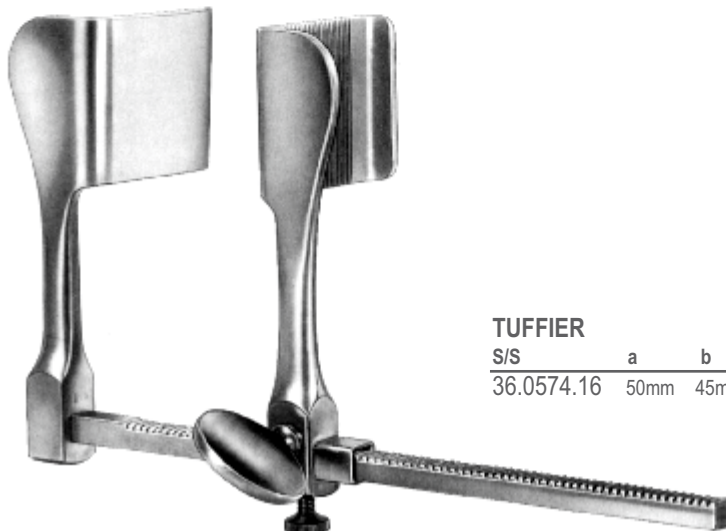

TUFFIER

S/S	a	b	c
36.0574.16	50mm	45mm	165mm

Rib Spreaders
 Rippensperrer
 Separadores
 Ранорасширители реберные
 胸骨牵开器



Scheme of dimensions

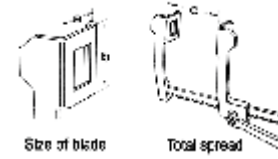

HAIGHT

S/S	a	b	c
36.0580.14	30mm	30mm	90mm

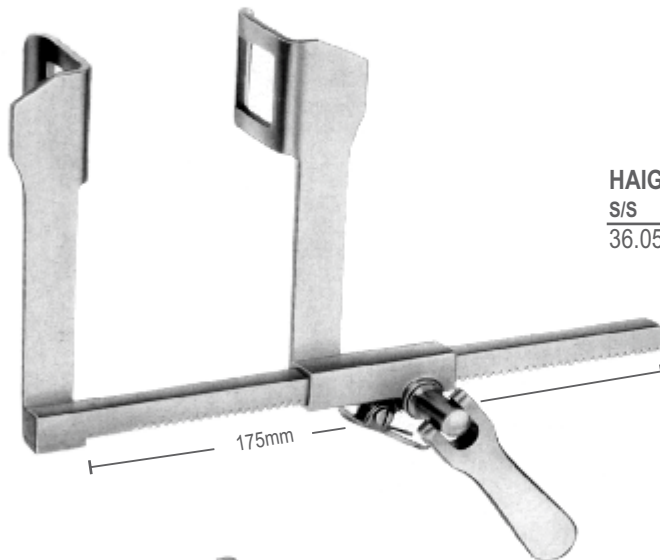

HAIGHT

S/S	a	b	c
36.0582.15	30mm	30mm	115mm



HERTZLER

S/S	a	b	c
36.0590.15	20mm	25mm	105mm

THORACIC & LUNG SURGERY

Scheme of dimensions

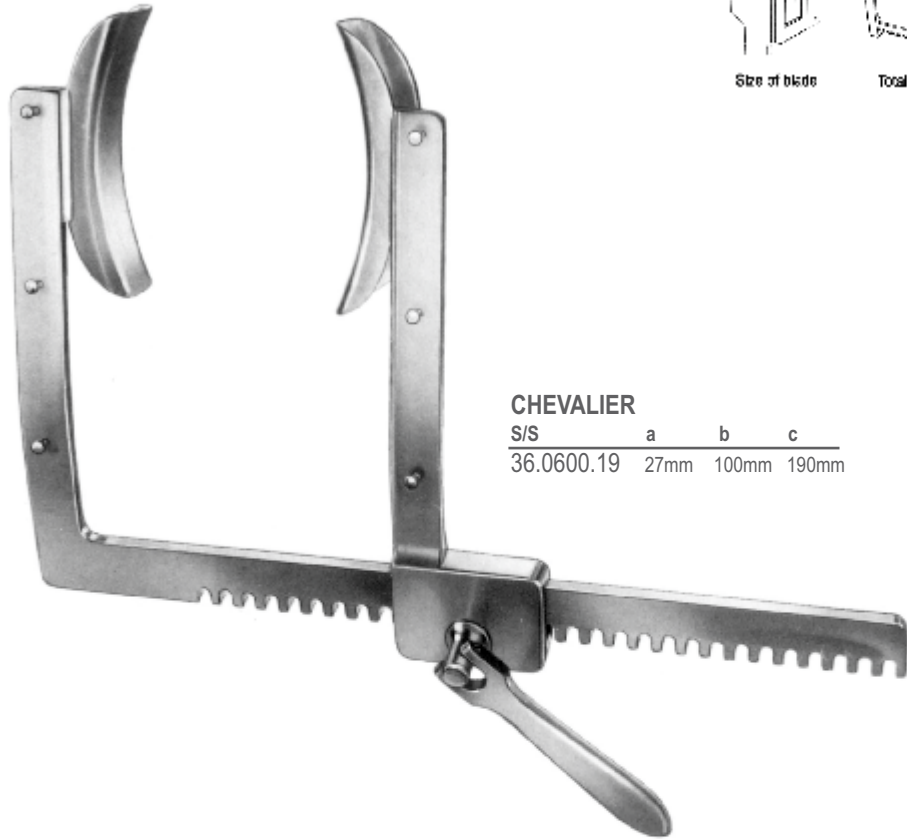
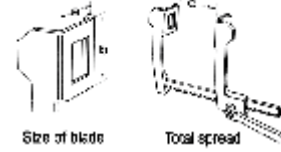

CHEVALIER

S/S	a	b	c
36.0600.19	27mm	100mm	190mm

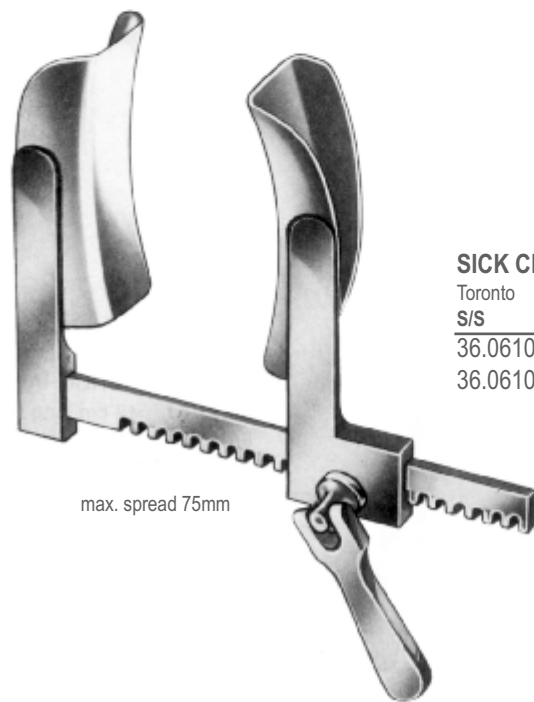

SICK CHILDREN HOSPITAL

Toronto

S/S	a	b	c
36.0610.01 (infant)	20mm	40mm	75mm
36.0610.02 (infant)	20mm	60mm	75mm

max. spread 75mm

Rib Spreaders
Rippensperrer
Separadores
Ранорасширители реберные
胸骨牵开器

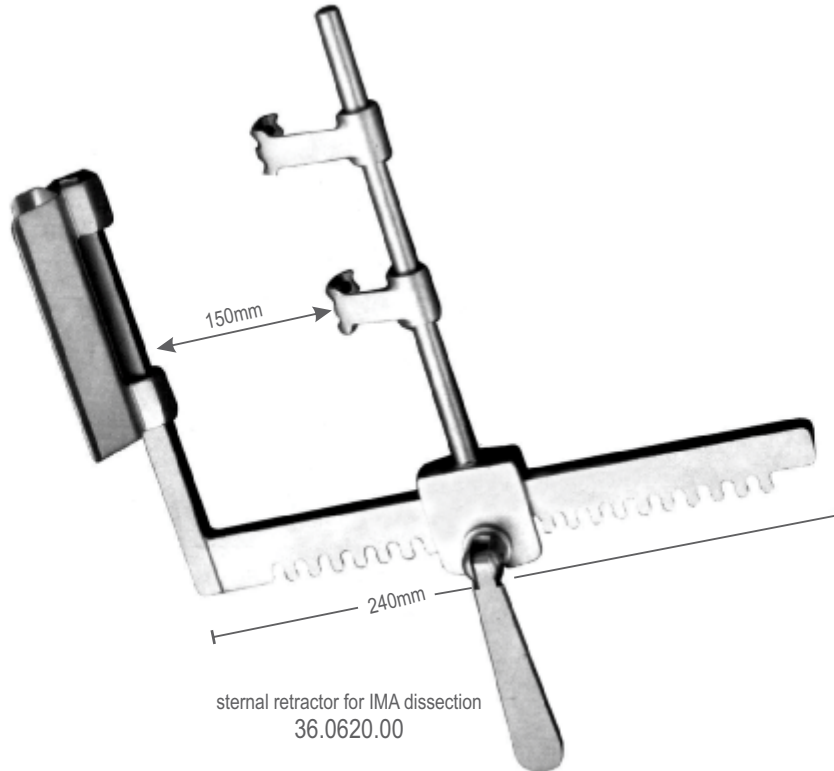

sternal retractor for IMA dissection
36.0620.00



Carpenter's thoracic retractor
(adult)
36.0630.00 complete

THORACIC & LUNG SURGERY

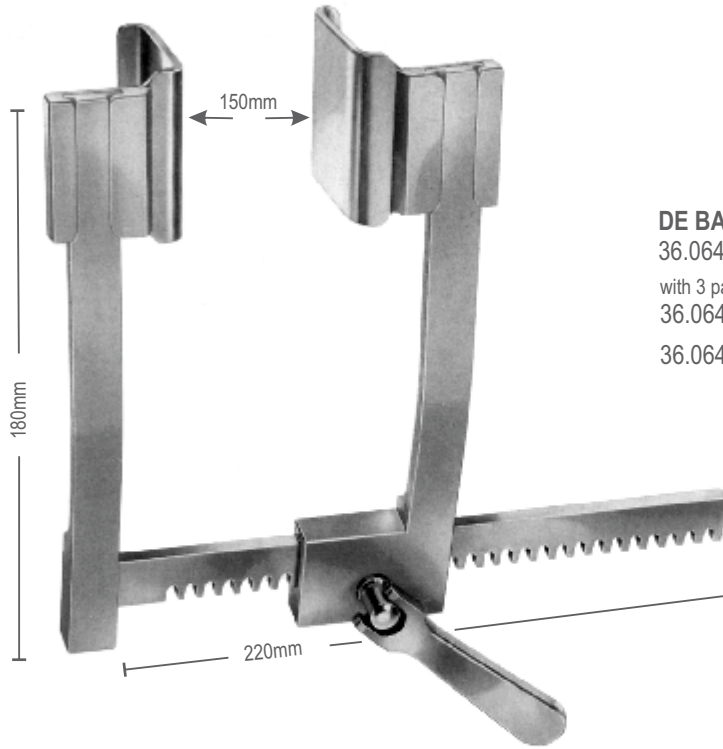

DE BAKEY
36.0640.00
with 3 pairs of blades
36.0640.01 / 36.0640.02 / 36.0640.03
36.0640.22 spreader only



Blades
36.0640.01
30 x 30 mm



Blades
36.0640.02
40 x 40 mm

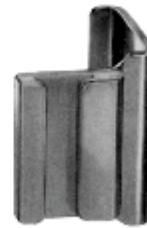

Blades
36.0640.03
50 x 50 mm

Rib Spreaders
 Rippensperrer
 Separadores
 Ранорасширители реберные
 胸骨牵开器

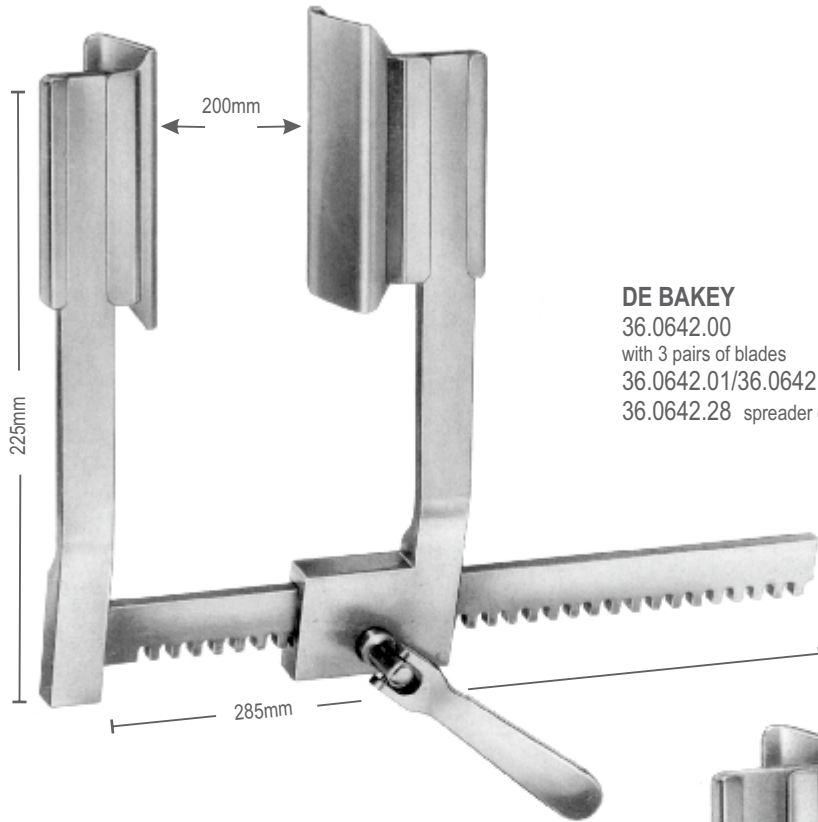

DE BAKEY
 36.0642.00
 with 3 pairs of blades
 36.0642.01/36.0642.02/36.0642.03
 36.0642.28 spreader only

THORACIC & LUNG SURGERY

blades
 36.0642.01
 60 x 60 mm

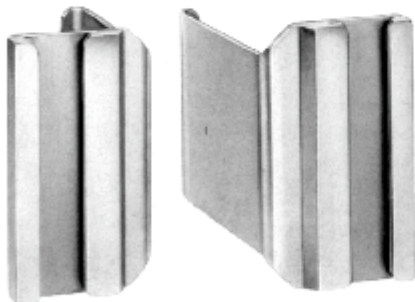

blades
 36.0642.03
 40 x 100 mm

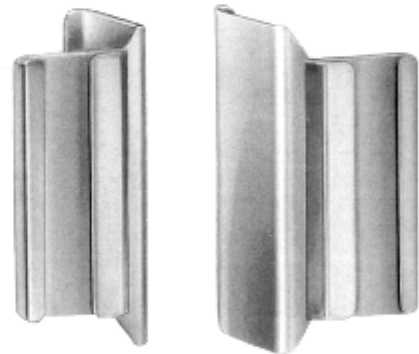

blades
 36.0642.04
 80 x 60 mm

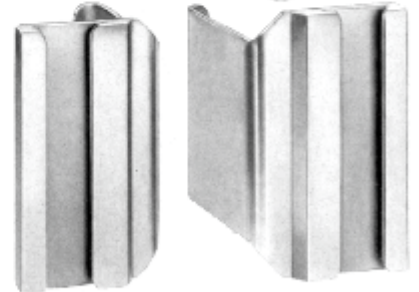

blades
 36.0642.02
 50 x 80 mm

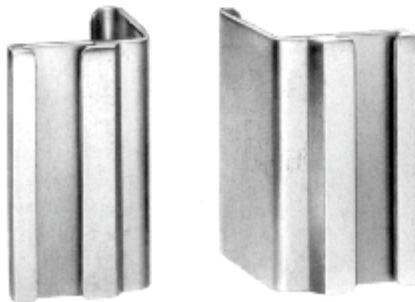

blades
 36.0642.05
 50 x 66 mm



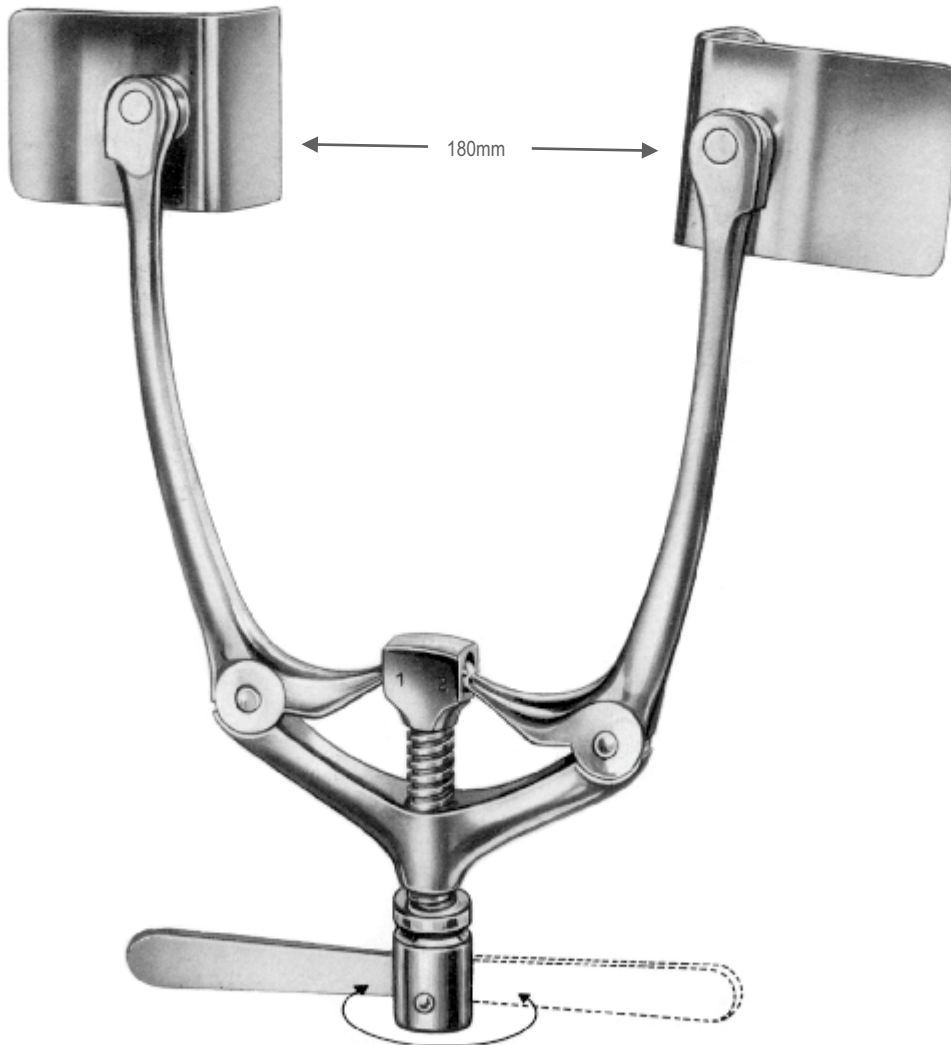

QUERVAIN
36.0650.00
35 X 50 X 180 mm

Rib Spreaders
Rippensperrer
Separadores
Ранорасширители реберные
胸骨牵开器



42 x 65 mm

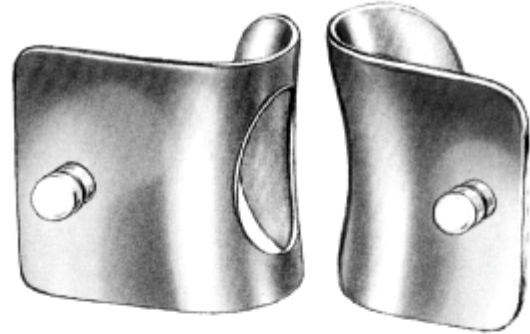

36.0660.65

75 x 75 mm

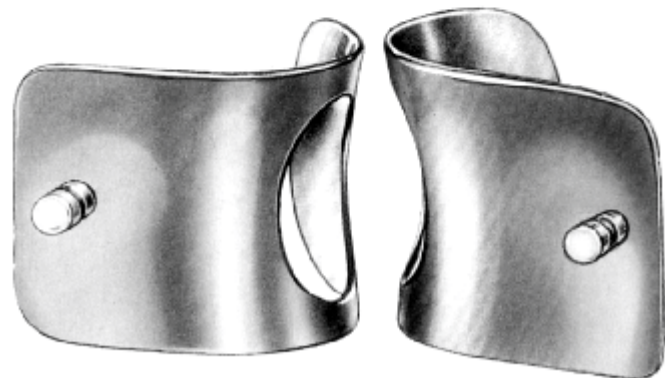

36.0660.75

36.0660.00 complete consisting of:
36.0660.01 retractor only
36.0660.65 1 pair blades 42x65mm
36.0660.75 1 pair blades 75x75mm

THORACIC & LUNG SURGERY

Rib Contractors, Lung Spatula
Rippenkontraktoren, Lungenspatel
Aproximadores para costillas, espatula pulmonar
Шпатели легочные, Фиксаторы для рёбер
罗纹承包商, 龙锅铲

THORACIC & LUNG SURGERY



ALLISON
36.0690.25 25.0cm
36.0690.30 30.0cm
36.0690.32 32.0cm



36.0700.26
26.0cm

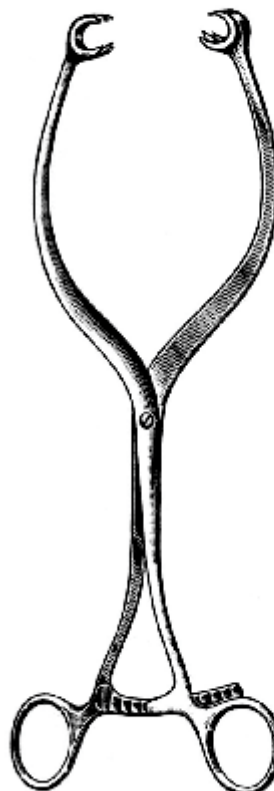

CRAFOORD
36.0710.28
28.0cm



BAILEY-BABY
36.0720.14 14.0cm



BAILEY
36.0722.16 16.0cm
36.0722.20 20.0cm



BAILY-GIBBON
36.0724.16 16.0cm
36.0724.20 20.0cm



36.0730.19
19.0cm

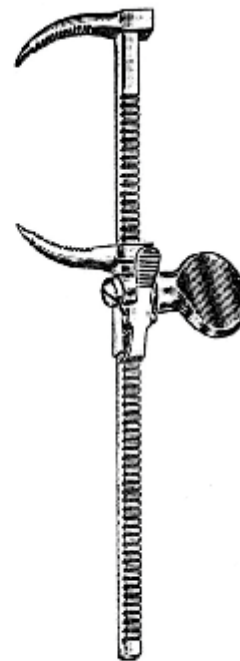

LEMMON
36.0740.14 14.5cm
36.0740.18 18.0cm

Bronchus Forceps, Ligature Forceps
 Bronchusklemmen, Ligaturklemmen
 Pinzas clamps bronquiales, pinzas para ligaduras
 Зажимы для легкого
 支气管钳

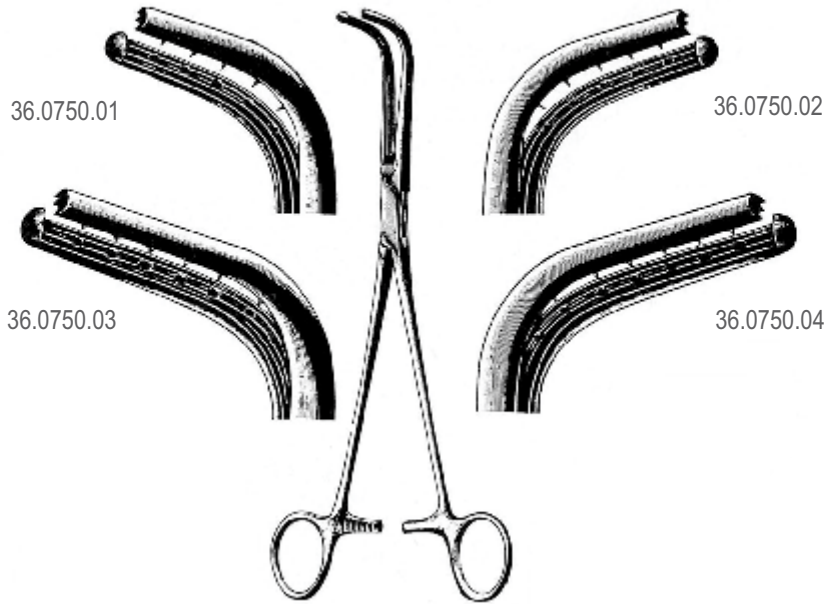

SAROT
23.0cm



36.0760.22

PRICE-THOMAS
22.0cm



36.0762.22

PRICE-THOMAS
22.0cm

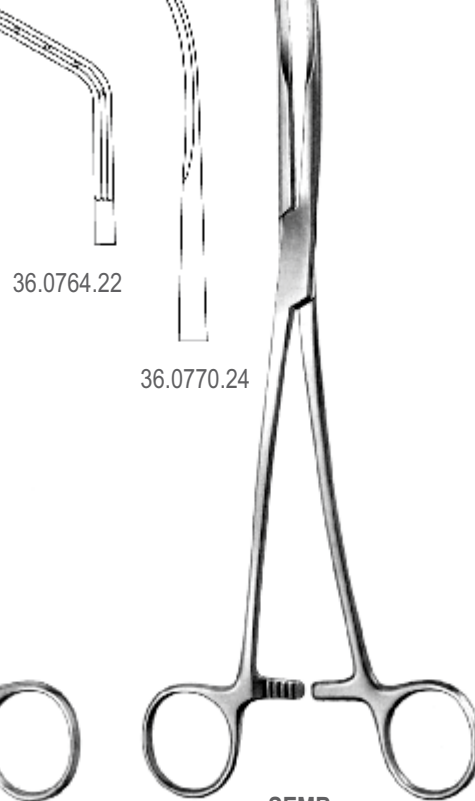

36.0770.24

SEMB
24.0cm

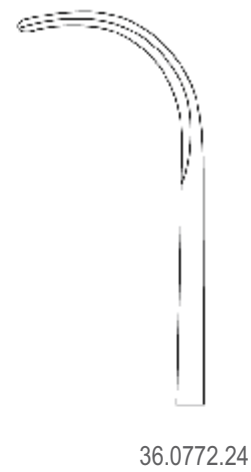

36.0772.24

THORACIC & LUNG SURGERY



SURGICAL
INSTRUMENTS



THE ULTIMATE CHOICE

Hilton
PREMIUM STAINLESS STEEL



THE ULTIMATE CHOICE

DERMATOLOGY

Dermatology
Dermatologie
Dermatologia
ДЕРМАТОЛОГИЯ
皮肤科

Lupus Curettes, Hooklets, Trephines
 Lupusloffel, Hakchen, Trephinen
 Curetas para lupus, ganchos, trepanos
 Кюретки, Крючки
 皮肤刮、环钻、皮肤拉钩



PIFFARD
14.5cm

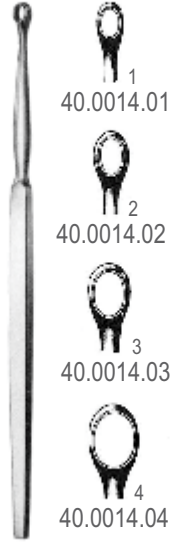

FOX
14.0cm

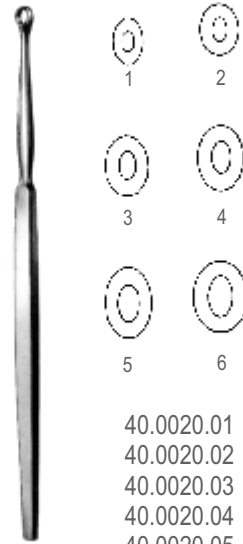

WOLFF
14.0cm



VIDAL
40.0024.14 14.0cm



MONCORPS
40.0030.14 14.0cm



KEYS
10.0cm

- 1 40.0040.02 2mm
- 2 40.0040.03 3mm
- 3 40.0040.04 4mm
- 4 40.0040.05 5mm
- 5 40.0040.06 6mm
- 6 40.0040.07 7mm
- 7 40.0040.08 8mm



KILNER
40.0050.15 15.0cm



GILLIES
18.0cm

DERMATOLOGY

Comedo Extractors, Biopsy Set
 Komedoneninstrumente, Biosiebesteck
 Saca-comedones, estuche para biopsia
 Экстракторы угревые, Комплект для биопсии
 粉刺提取器, 活检套装

DERMATOLOGY



SCHAMBERG
40.0060.10 10.0cm

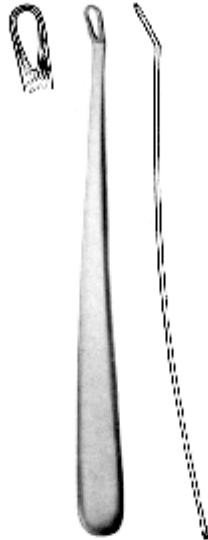

GILLESBERGER
40.0064.14 14.5cm



SAALFELD
40.0070.10 10.0cm



SAALFELD
40.0074.14 14.0cm



UNNA
40.0080.14 14.0cm



UNNA
40.0084.14 14.0cm



40.0090.00
 Biopsy set for taking skin specimen
 core drills 1.5, 3.0, 4.5mm ø



40.0100.13
 13.0cm



40.0104.13
 13.0cm



KATSCH
40.0110.14
 14.0cm



UNNA-VIDAL
40.0114.11
 11.5cm



SURGICAL
INSTRUMENTS



THE ULTIMATE CHOICE

Hilton
PREMIUM STAINLESS STEEL



THE ULTIMATE CHOICE

INTESTINAL & STOMACH

Intestinal and Stomach

Daram und Magen

Intestinal y el estomago

ИНСТРУМЕНТЫ ДЛЯ ОПЕРАЦИЙ НА ЖЕЛУДКЕ И КИШЕЧНИКЕ

肠和胃

52

001 - 019

Tissue and Intestinal Forceps
 Gewebe und Darmklemmen
 Pinzas para tejido y intestinales
 Зажимы для кишечника и желудка
 组织钳



ALLIS-BABY
 52.0010.12 12.0cm
 4:5 teeth



ALLIS
 4:5 teeth 5:6 teeth
 52.0020.15 15.0cm 52.0022.15
 52.0020.19 19.0cm 52.0022.19
 52.0020.22 22.0cm 52.0022.22
 52.0020.25 25.0cm 52.0022.25



BOYS-ALLIS
 52.0030.15 15.0cm

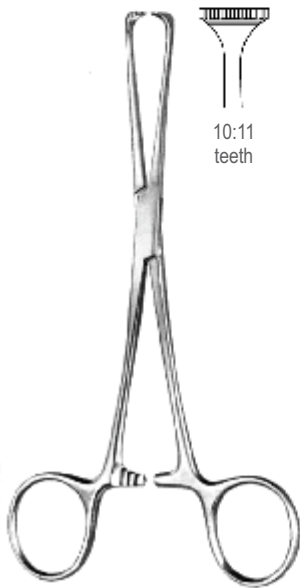

ALLIS-ADAIR
 52.0040.15 15.5cm



JUDD-ALLIS
 52.0050.15 15.0cm
 52.0050.19 19.0cm



ALLIS-ATRAUMA

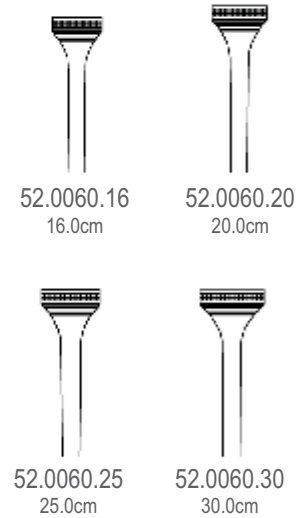

INTESTINAL & STOMACH



THOMS-ALLIS
52.0070.20 20.0cm



ALLIS
52.0080.20 20.0cm

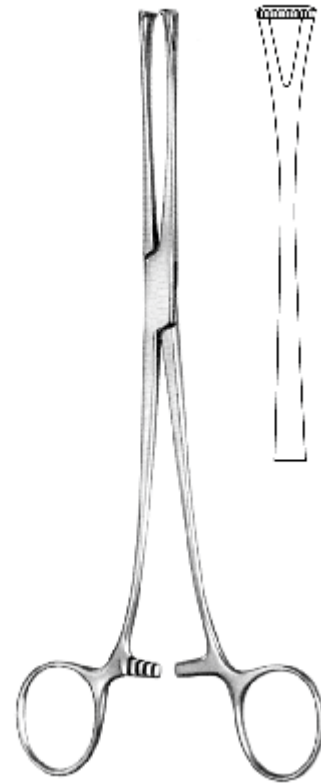

LOCKWOOD
52.0090.20 20.0cm

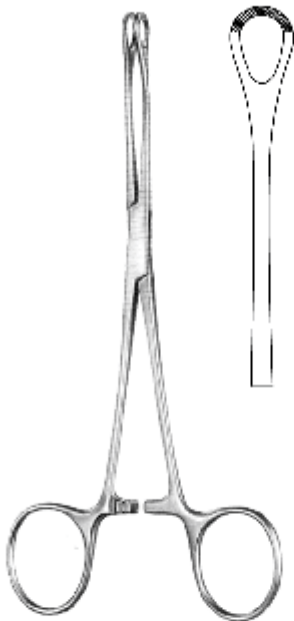

WILLIAMS
52.0100.16 16.0cm

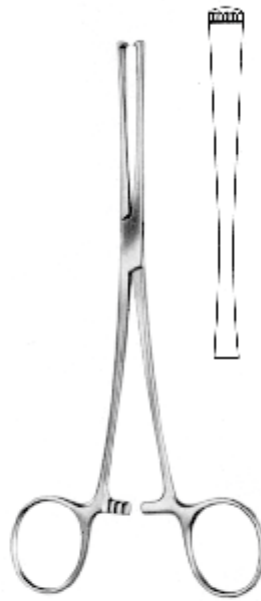

LOCKWOOD-ALLIS
52.0110.16 16.0cm
52.0110.20 20.0cm

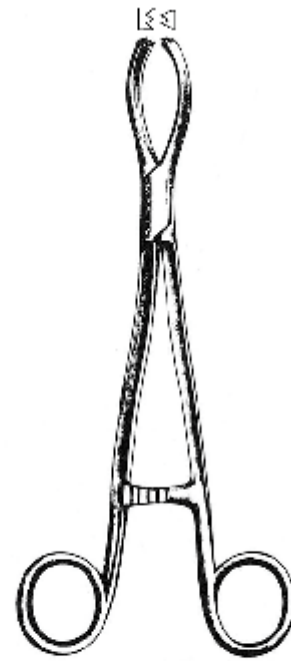

LITTLEWOOD
52.0120.19 19.0cm

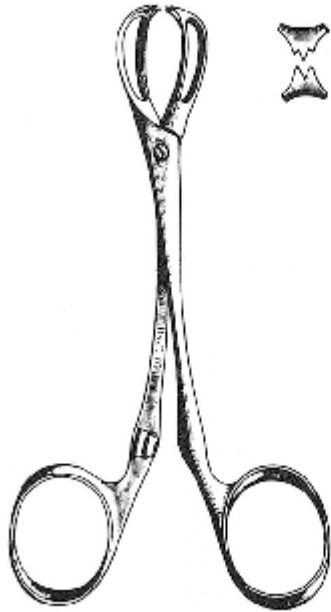

LANE
 52.0130.12 12.5cm
 52.0130.15 15.0cm
 52.0130.19 19.0cm

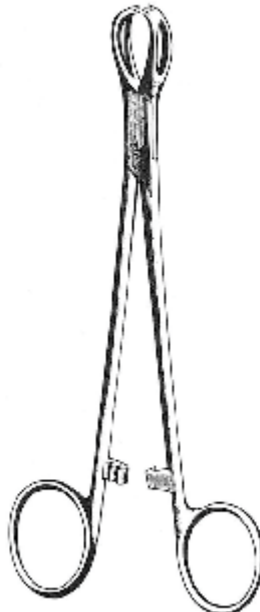

LANE
 52.0134.12 12.5cm
 52.0134.15 15.0cm
 52.0134.19 19.0cm

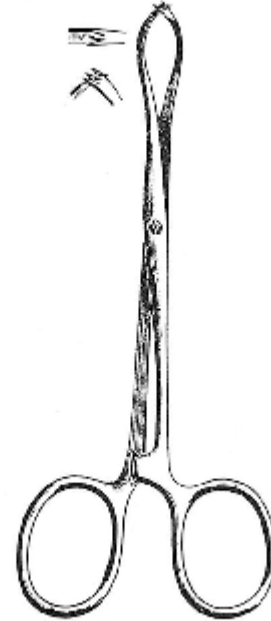

PORRIER
 52.0140.12 12.5cm
 52.0140.18 18.0cm

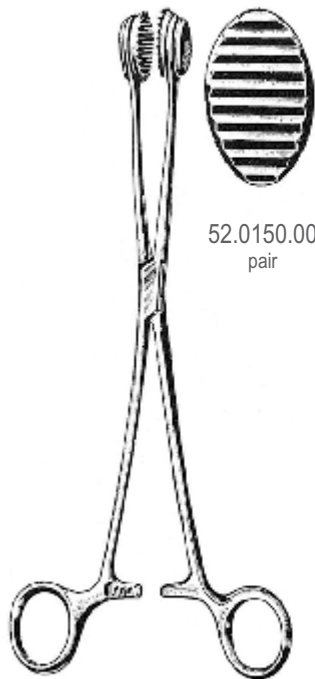

CHILDS
 52.0150.24
 24.0cm

52.0150.00
 pair

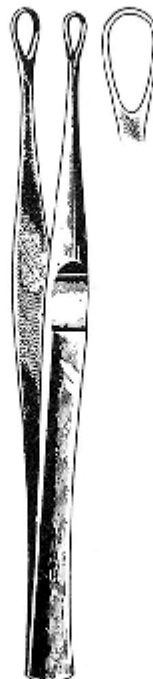

DENIS-BROWNE
 52.0160.18
 18.0cm



YOUNG
 52.0170.21
 21.0cm

INTESTINAL & STOMACH



BABCOCK

52.0180.16 16.0cm
52.0180.18 18.0cm
52.0180.20 20.0cm
52.0180.24 24.0cm



BABCOCK

52.0182.16 16.0cm
52.0182.18 18.0cm
52.0182.20 20.0cm
52.0182.24 24.0cm

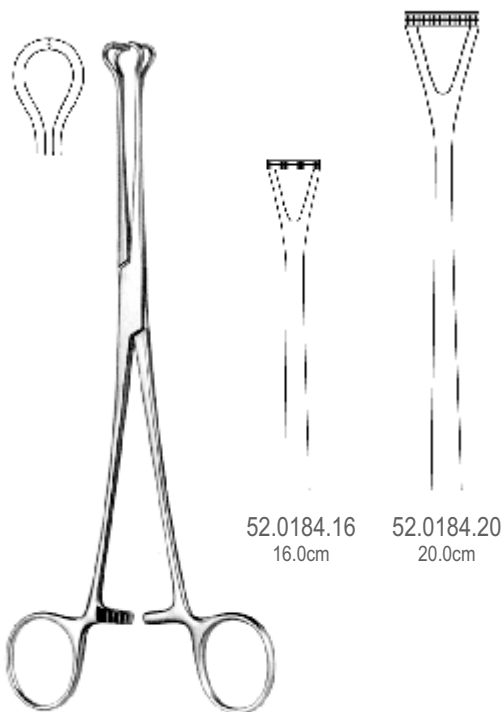

BABCOCK-ATRAUMA

52.0184.16
16.0cm

52.0184.20
20.0cm

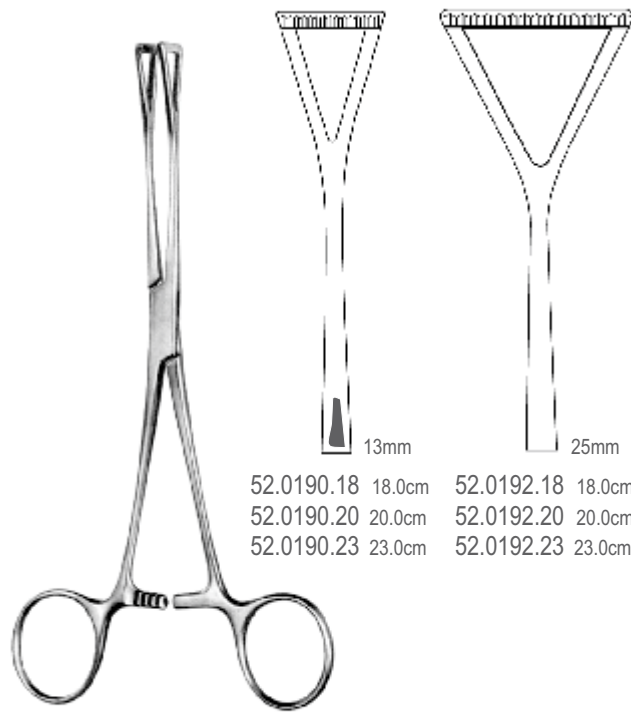

DUVAL

52.0190.18 18.0cm
52.0190.20 20.0cm
52.0190.23 23.0cm

52.0192.18 18.0cm
52.0192.20 20.0cm
52.0192.23 23.0cm

13mm

25mm

Intestinal Clamp Forceps
 Darmklemmen
 Pinzas-clamps intestinales
 Зажимы для кишечника и желудка
 肠夹

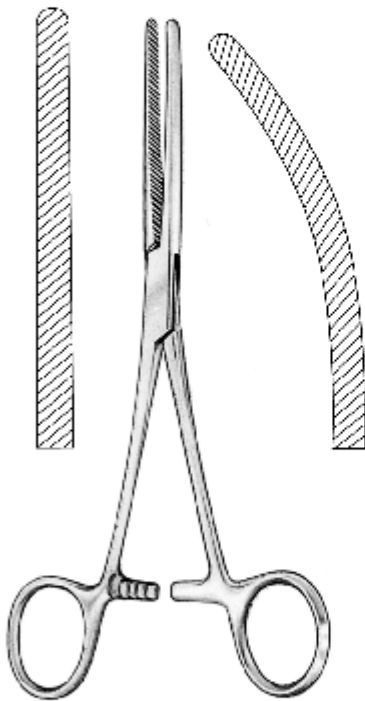

BABY-DOYEN
 52.0200.18 18.0cm 52.0201.18

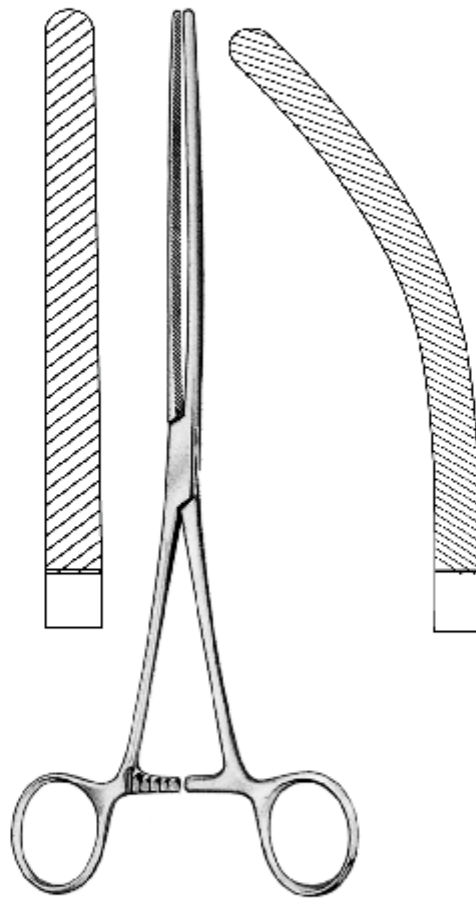

DOYEN
 52.0204.21 21.0cm 52.0205.21
 52.0204.23 23.0cm 52.0205.23

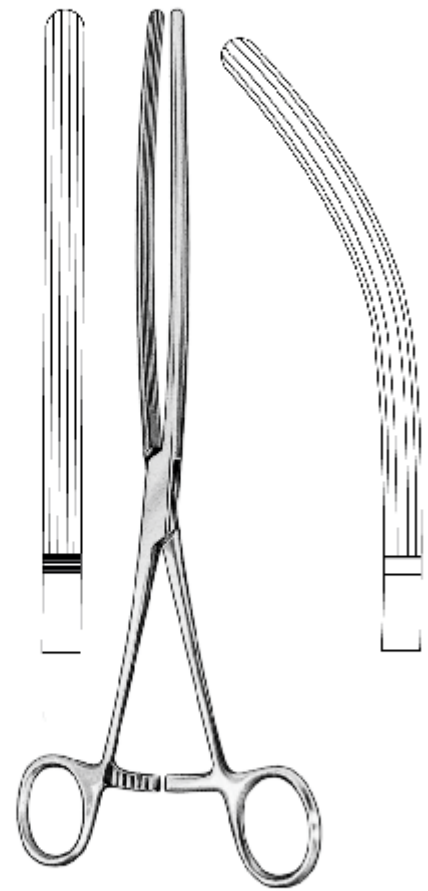

MAYO-ROBSON
 52.0210.21 21.0cm 52.0211.21
 52.0210.23 23.0cm 52.0211.23
 52.0210.25 25.0cm 52.0211.25

INTESTINAL & STOMACH

Intestinal and Appendix Clamps Forceps
Darmklemmen, Blinddarmklemme
Pinzas-clamps intestinales y para apendice
Зажимы для кишечника и желудка
肠夹

INTESTINAL & STOMACH

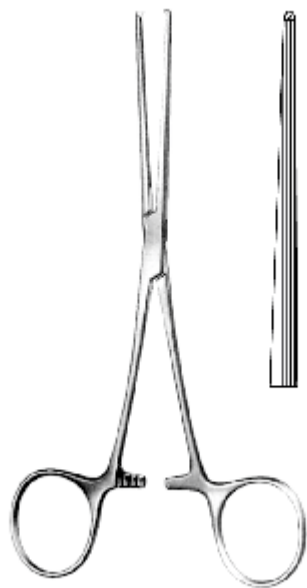

ALLEN
52.0220.15 15.5cm

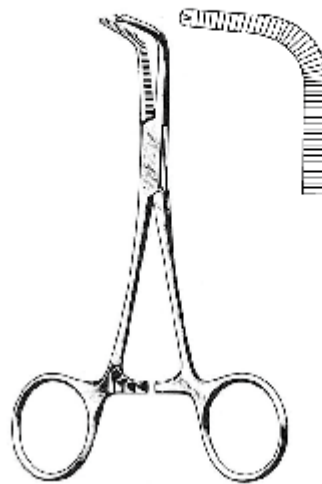

KLEINSCHMIDT
52.0230.12 12.0cm

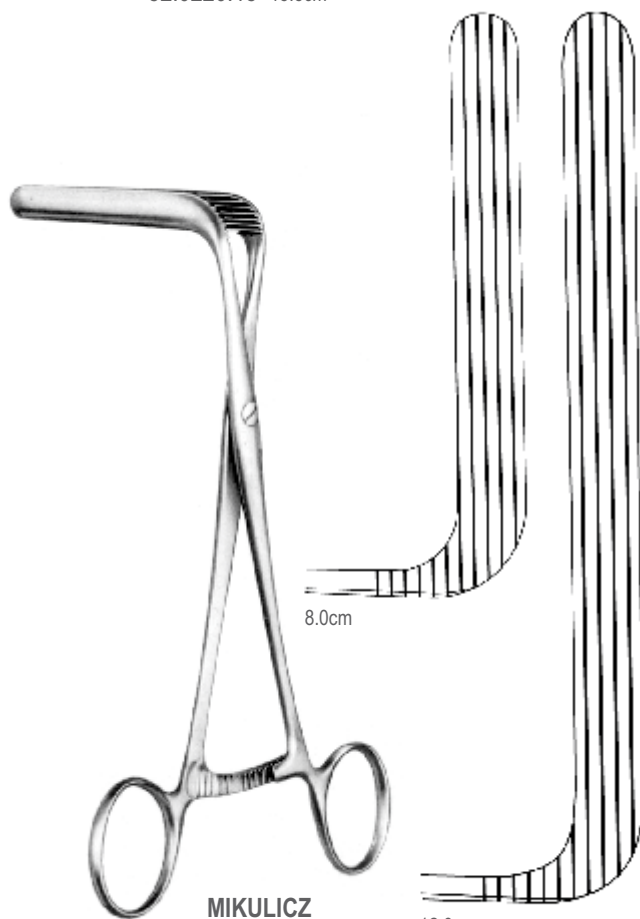

MIKULICZ
52.0240.08 8.0cm
52.0240.12 12.0cm

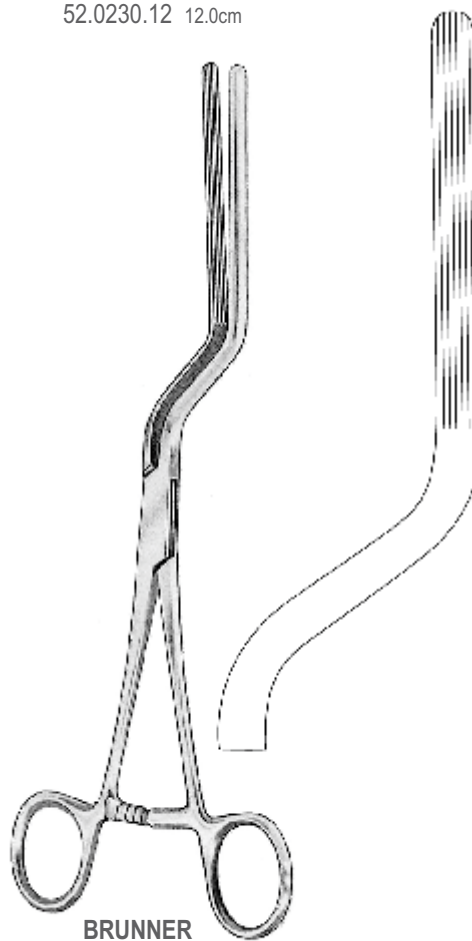

BRUNNER
52.0250.24 24.0cm

Intestinal Clamp Forceps
Darmklemmen
Pinzas-clamps intestinales
Зажимы для кишечника и желудка
肠夹

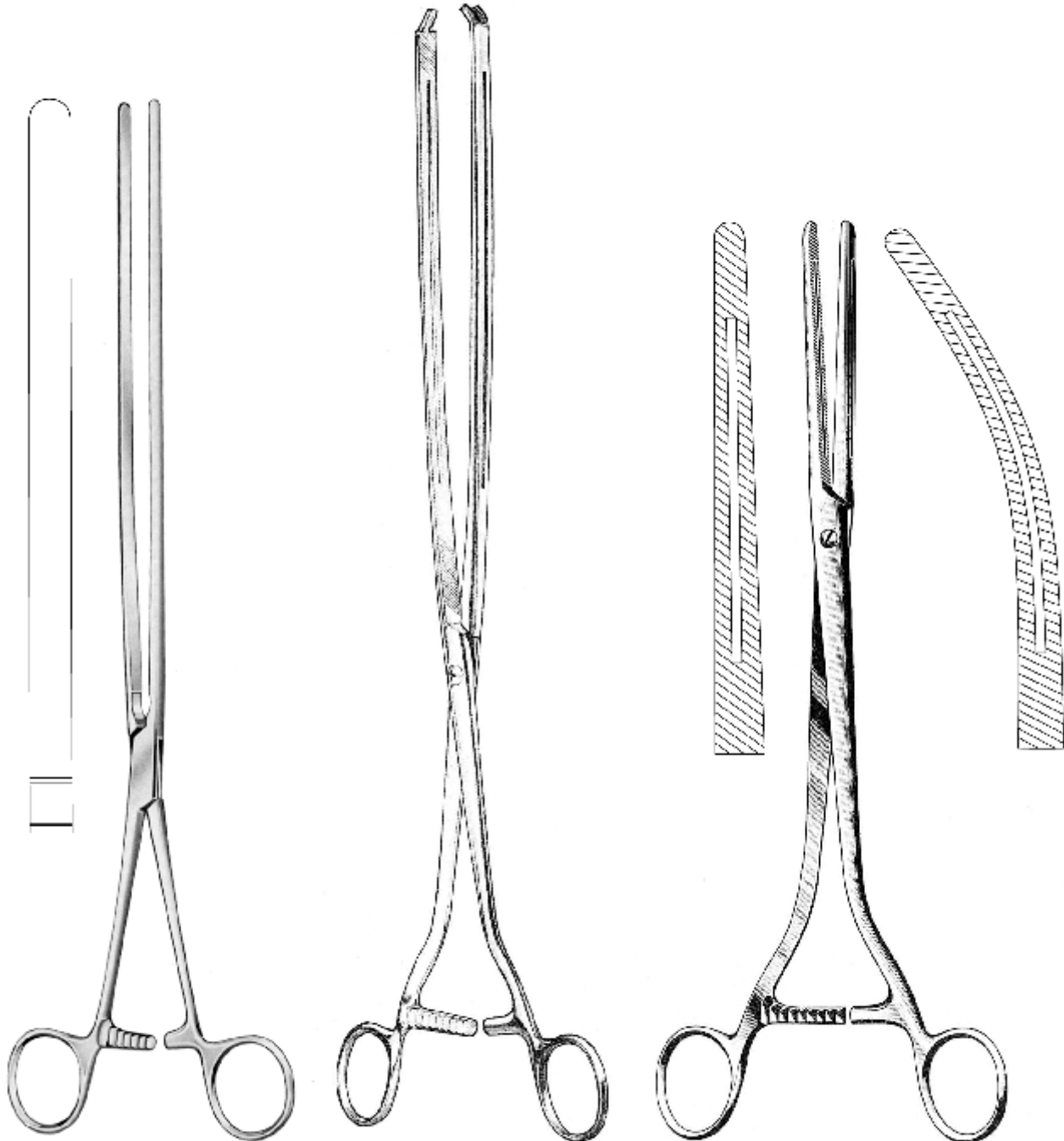

INTESTINAL & STOMACH

SCUDDER
52.0260.25 25.0cm 52.0261.25
52.0260.33 33.0cm 52.0261.33

MOYNIHAN
52.0270.36 36.0cm 52.0271.36

MOYNIHAN
52.0280.29 29.0cm 52.0281.29

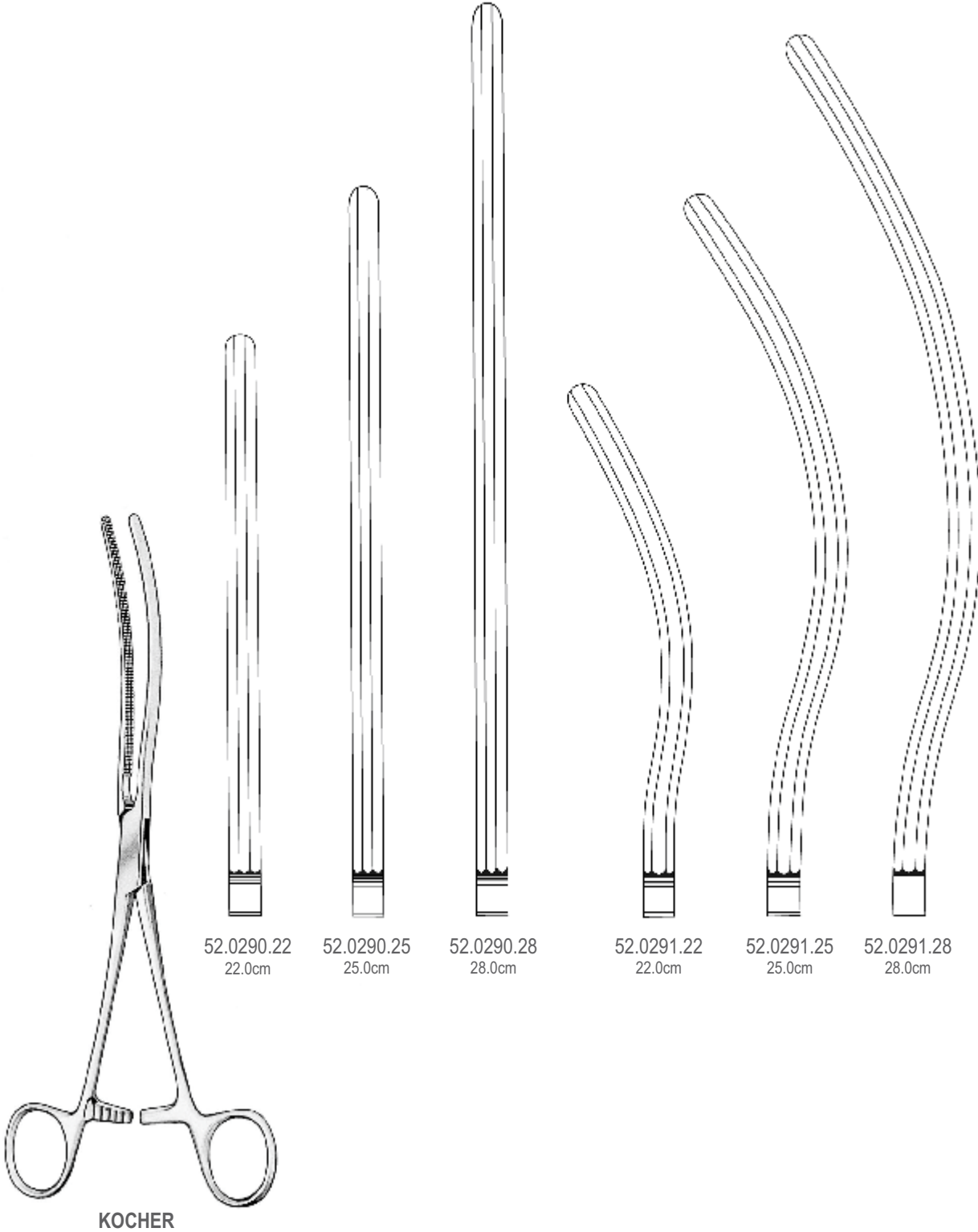

Atrauma Intestinal and Stomach Clamps
 Atrauma-Darm-und Magenklammern
 Atrauma pinzas clamps intestinales y estomacales
 Зажимы для кишечника и желудка
 非创伤性肠和胃箍



ATRAUMA



DOYEN-ATRAUMA

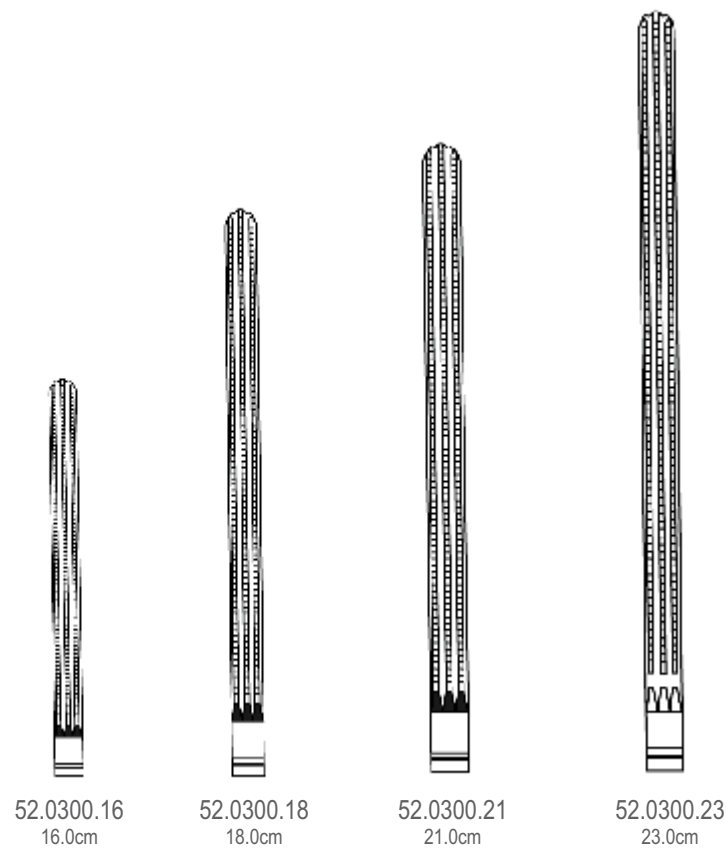

52.0300.16
16.0cm

52.0300.18
18.0cm

52.0300.21
21.0cm

52.0300.23
23.0cm

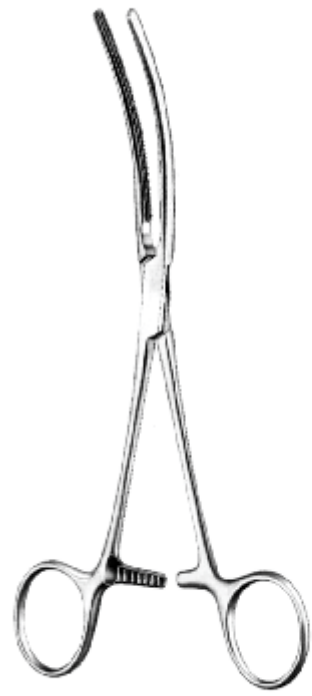

DOYEN-ATRAUMA

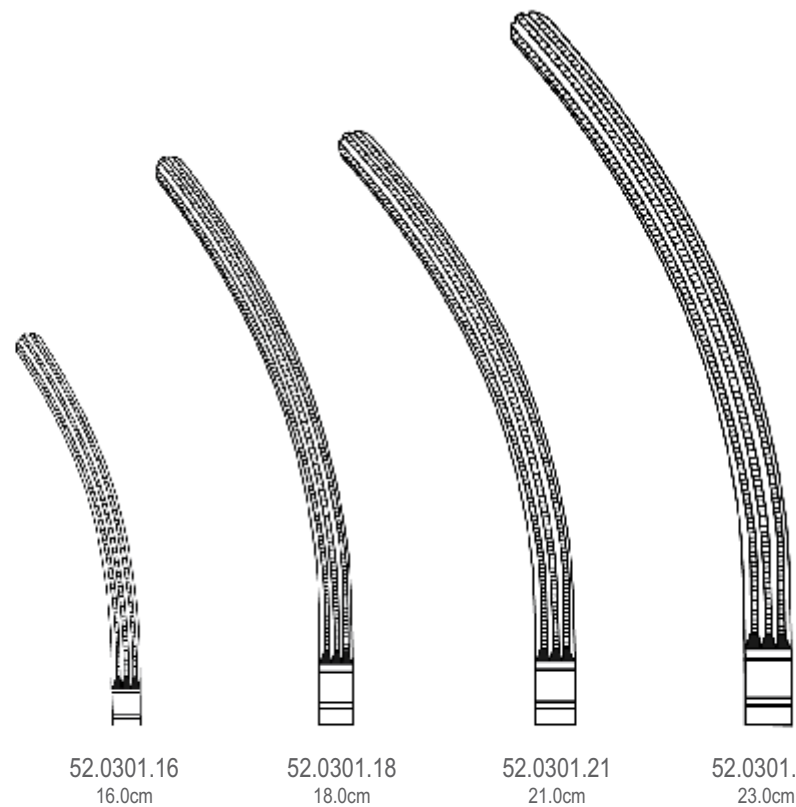

52.0301.16
16.0cm

52.0301.18
18.0cm

52.0301.21
21.0cm

52.0301.23
23.0cm

INTESTINAL & STOMACH

ATRAUMA

INTESTINAL & STOMACH



KOCHER-ATRAUMA



52.0310.22
22.0cm



52.0310.25
25.0cm



52.0310.28
28.0cm



52.0311.22
22.0cm



52.0311.25
25.0cm



52.0311.28
28.0cm

Atrauma Intestinal and Stomach Clamps
Atrauma-Darm-und Magenklammern
Atrauma pinzas clamps intestinales y estomacales
Зажимы для кишечника и желудка
非创伤性肠和胃箍



ATRAUMA



MAYO-ROBSON-ATRAUMA
52.0320.25 25.0cm



MAYO-ROBSON-ATRAUMA
52.0321.25 25.0cm

INTESTINAL & STOMACH

INTESTINAL & STOMACH

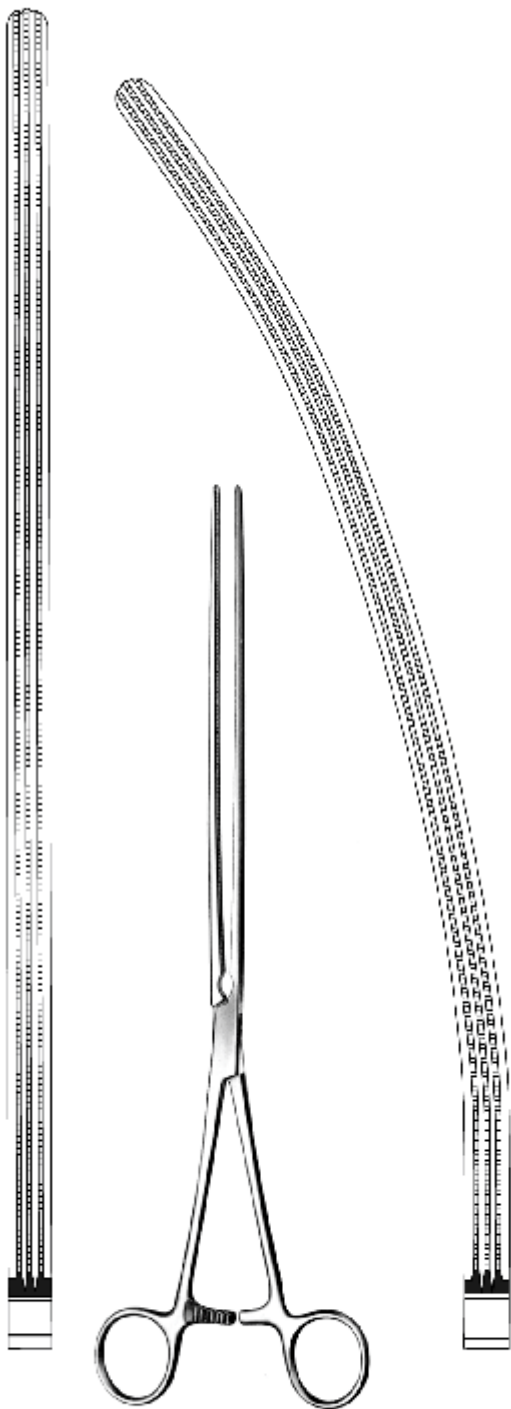

SCUDDER
52.0330.33 33.0cm 52.0331.33

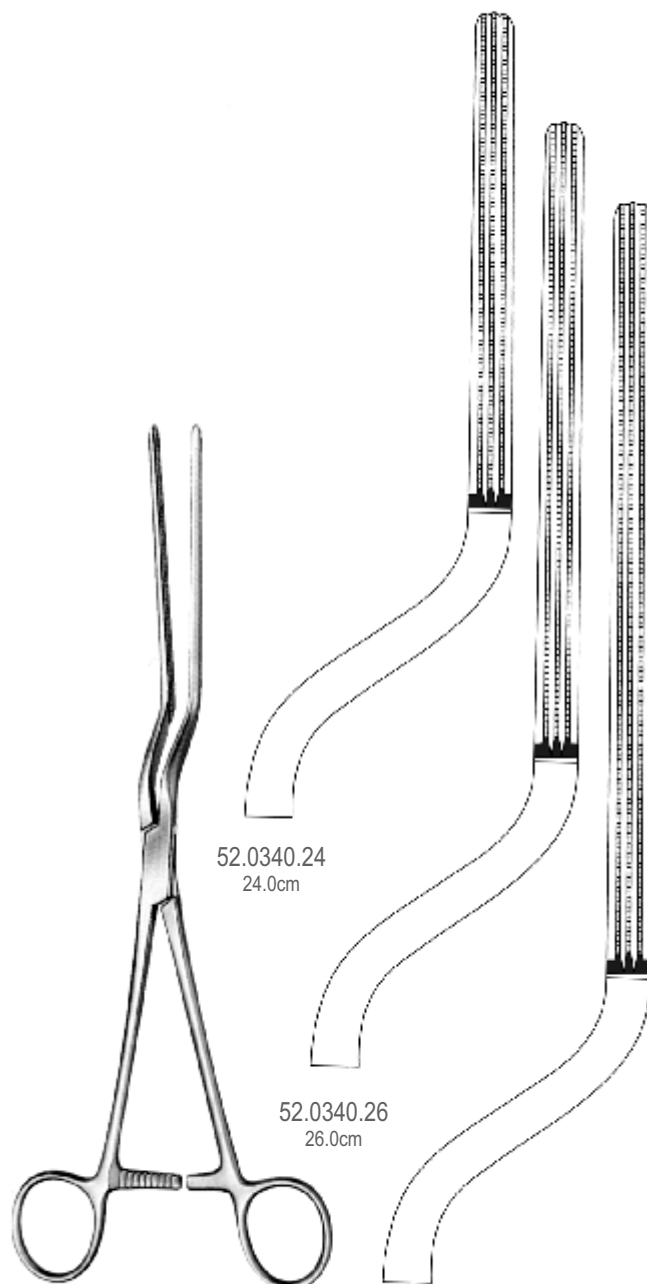

BRUNNER
52.0340.24 24.0cm
52.0340.26 26.0cm
52.0340.28 28.0cm

Atrauma Sigmoid Anastomosis Forceps
Atrauma Rektum-Anastomosenklemmen
Atrauma pinzas para anastomosis del recto
Зажимы для кишечника и желудка
非创伤性乙状结肠吻合钳



ATRAUMA

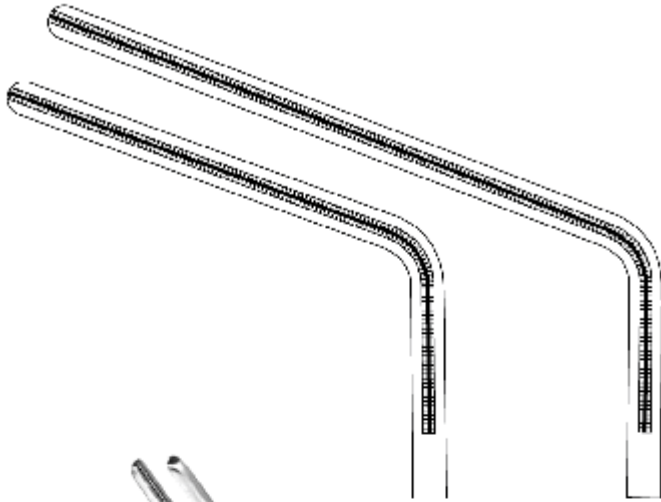

52.0350.26 26.0cm 52.0350.28 28.0cm

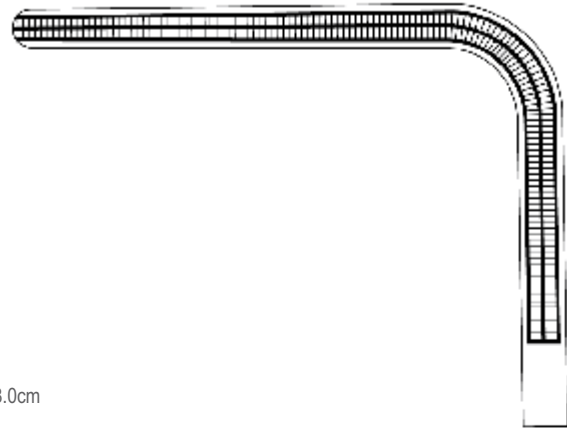

HAYES

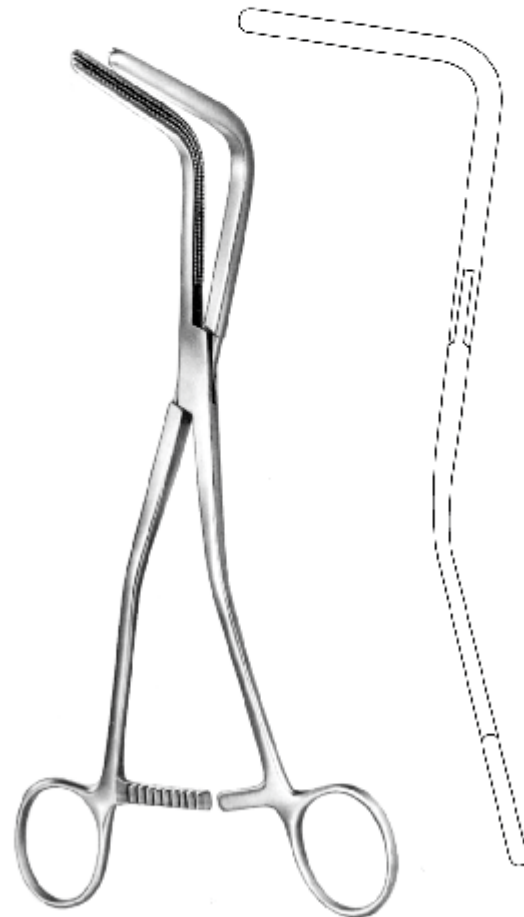

VEIDENHEIMER
52.0360.23 23.0cm

INTESTINAL & STOMACH

INTESTINAL & STOMACH



RESANO
52.0364.30 30.0cm



FEHLAND
52.0370.24 24.0cm

Intestinal and Stomach Clamps
Darm-und Magenklappen
Pinzas-clamps intestinales y estomacales
Зажимы для кишечника и желудка
肠道和胃夹

Hilton
PREMIUM STAINLESS STEEL

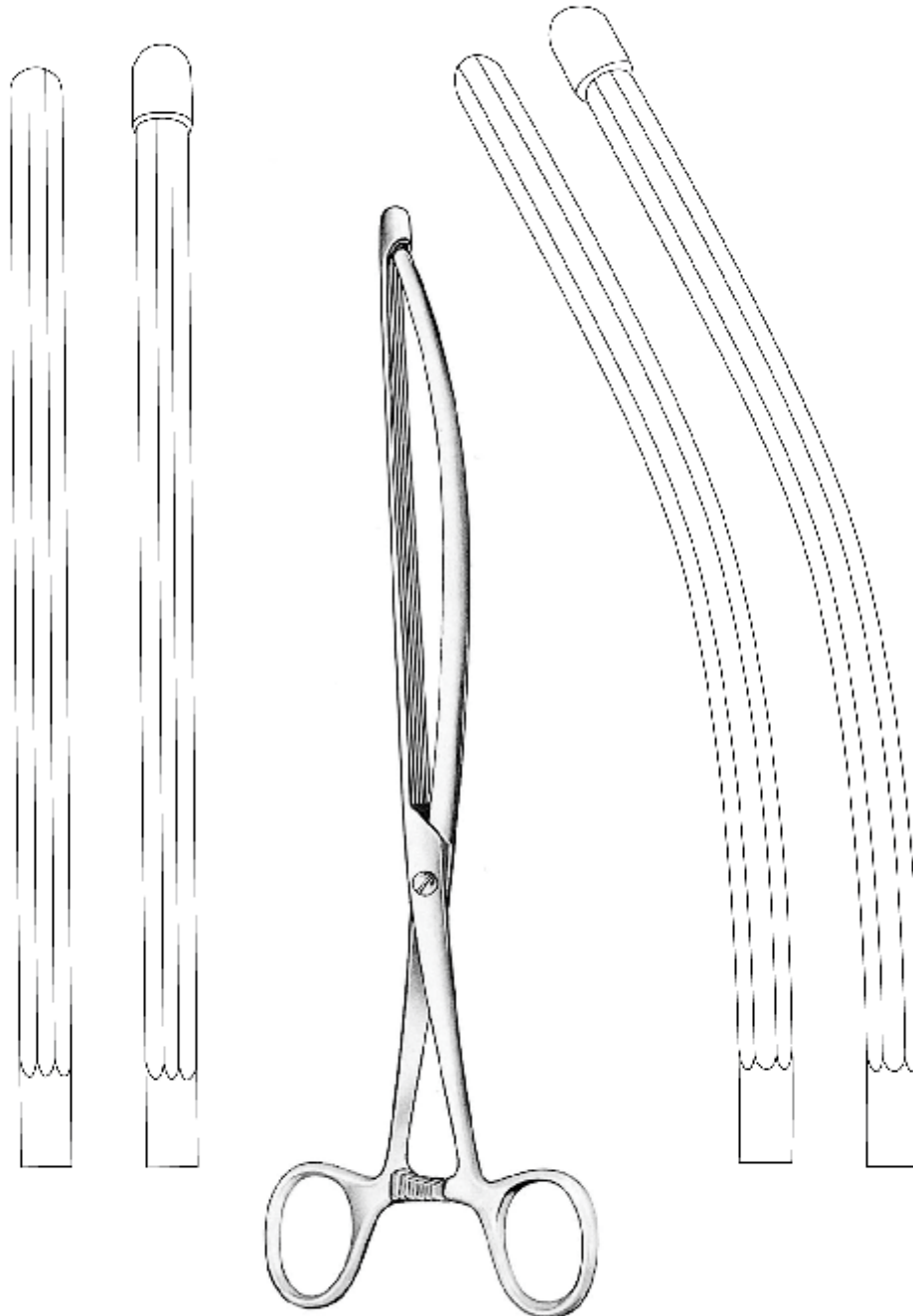

NUSSBAUM

52.0380.25 25.0cm 52.0381.25
52.0380.30 30.0cm 52.0381.30

INTESTINAL & STOMACH

INTESTINAL & STOMACH

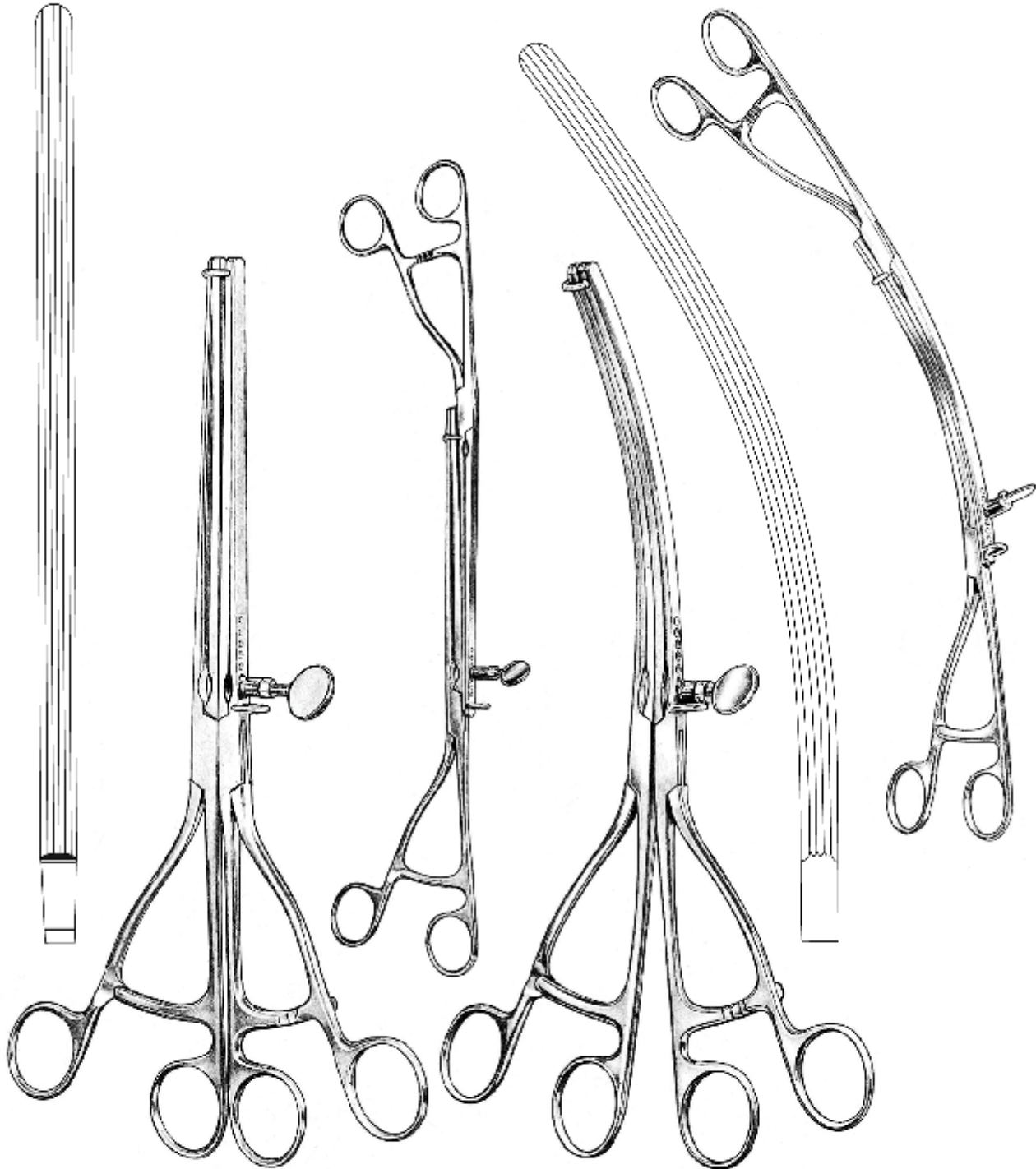

LANE
52.0390.30 30.0cm

LANE
52.0391.30 30.0cm

Intestinal and Stomach Clamps
Darm-und Magenklappen
Pinzas-clamps intestinales y estomacales
Зажимы для кишечника и желудка
肠道和胃夹

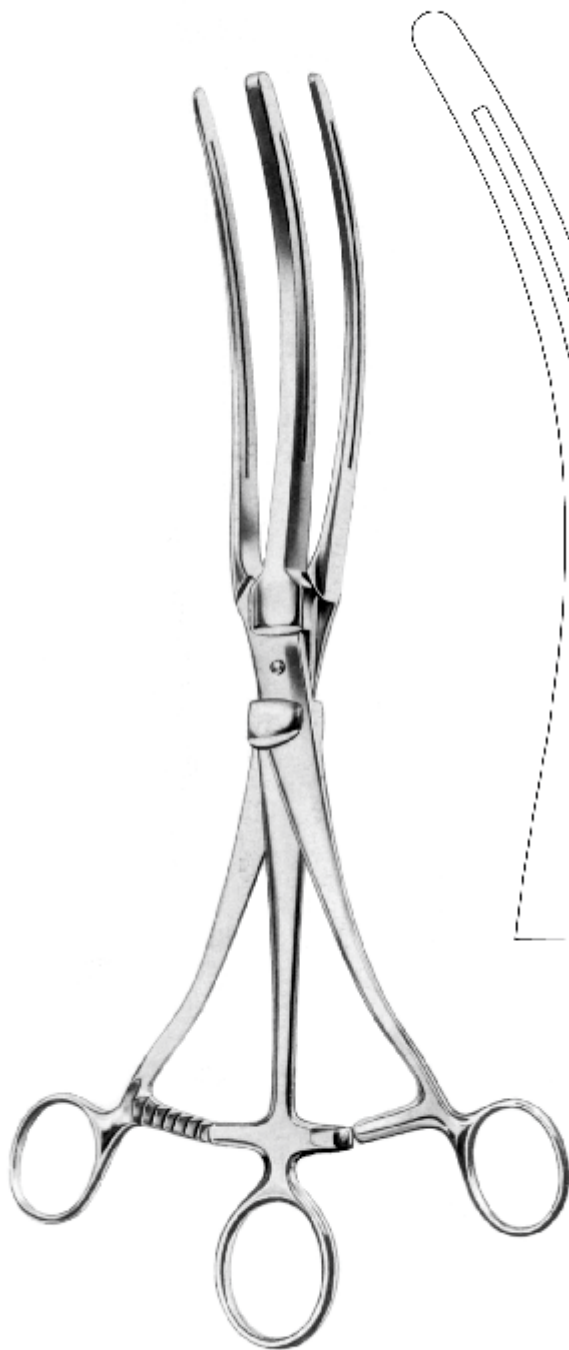

ROOSEVELT
52.0400.34 34.0cm

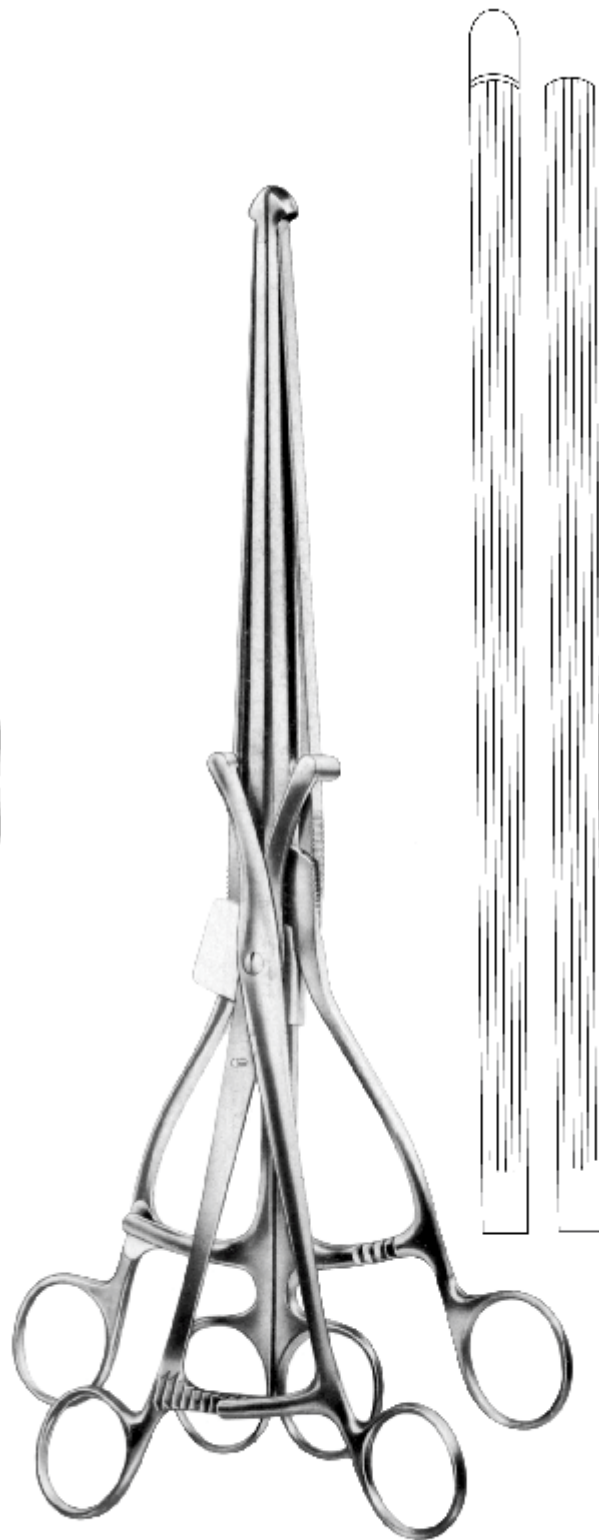

HABERER
52.0410.36 36.0cm

INTESTINAL & STOMACH



PAYR-BABY
52.0420.15 15.0cm



PAYR
52.0420.21 21.0cm



PAYR
52.0420.29 29.0cm



PAYR
52.0420.35 35.0cm

Intestinal and Anastomosis Clamps Forceps
 Darmklemmen, Anastomosenklemmen
 Pinzas-clamps intestinales y para anastomosis
 Зажимы для кишечника и желудка
 肠吻合夹



STONE-WATT
52.0432.00



52.0434.08 8.5cm



STONE-WATT
52.0436.07 7.5cm
52.0436.10 10.0cm

STONE
52.0430.15 15.5cm



DE MARTEL-WOLFSON
52.0440.05 5.0cm
52.0440.07 7.0cm
52.0440.10 10.0cm



DE MARTEL-WOLFSON
52.0444.23 23.0cm

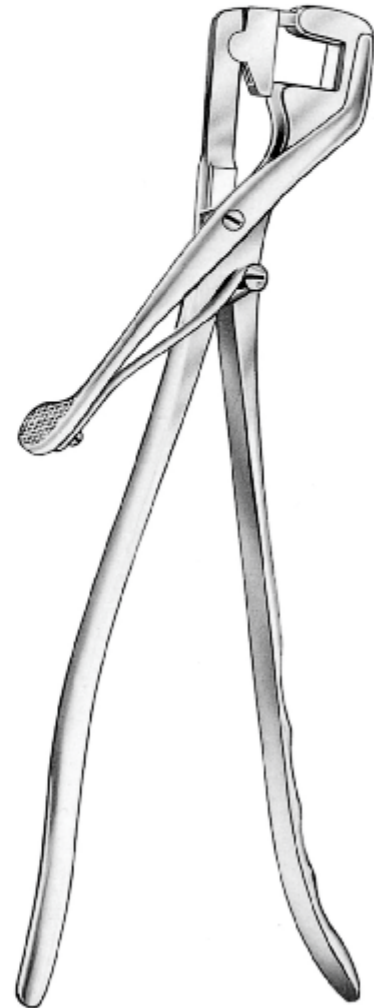

DE MARTEL-WOLFSON
52.0450.26 26.0cm

INTESTINAL & STOMACH



SURGICAL
INSTRUMENTS



THE ULTIMATE CHOICE

Hilton
PREMIUM STAINLESS STEEL



THE ULTIMATE CHOICE

RECTUM

Rectum

Rektum

Recto

РЕКТАЛЬНЫЕ ИНСТРУМЕНТЫ

直肠

54

001 - 012

Rectal Specula
 Mastdarm-Spekule
 Especulos rectales
 Зеркала ректальные
 肛门镜

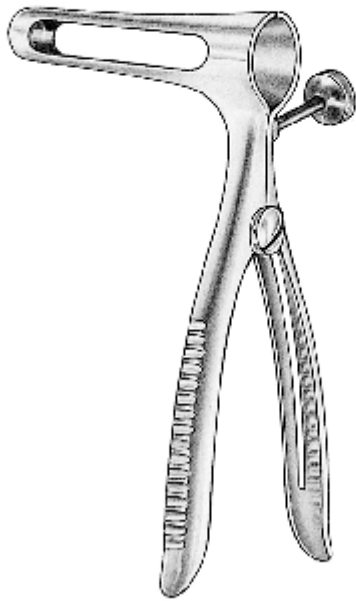

SIMS
 54.0010.15 15.0cm

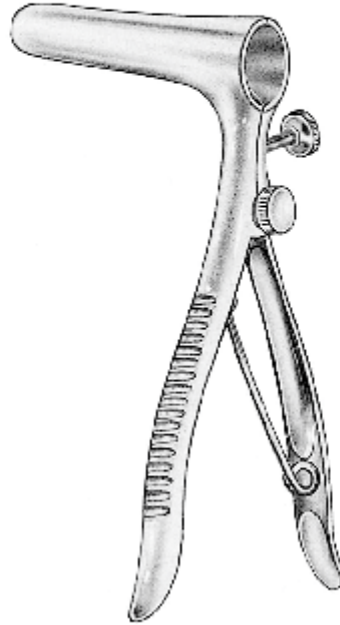

SIMS
 54.0012.15 15.0cm

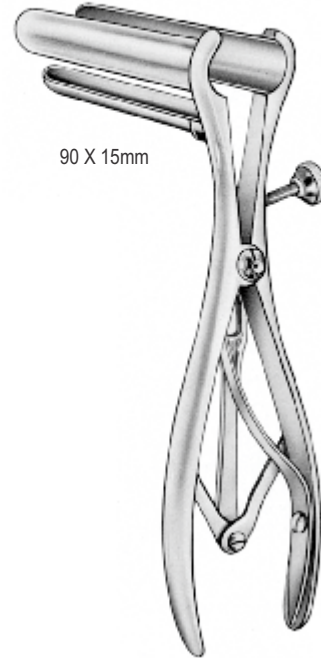

90 X 15mm

MATHIEU
 54.0020.19 19.5cm



SIMS
 54.0030.15 15.0cm



SCHULZE-BERGMANN
 22.0cm
 54.0040.06 60mm
 54.0040.08 80mm
 54.0040.12 125mm
 54.0040.15 150mm

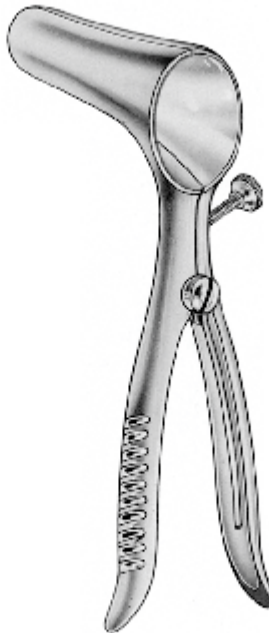

PRATT
 54.0050.21 21.5cm

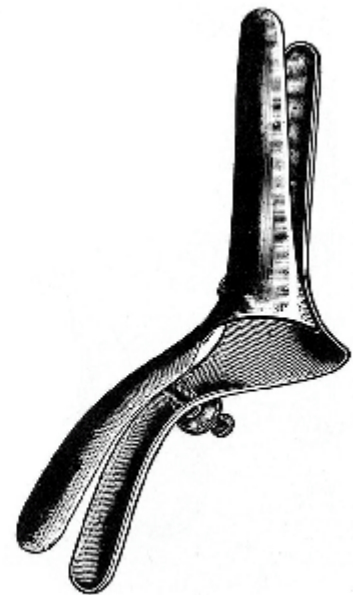

RICORD
 54.0060.00

RECTUM



KELLY

54.0070.01 21mm Ø x 50mm
54.0070.02 27mm Ø x 50mm

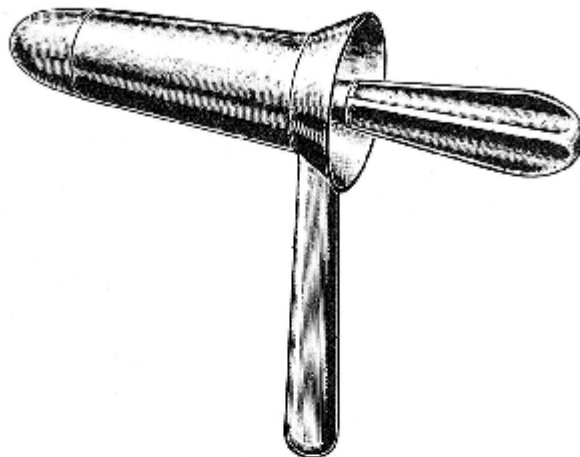

KELLY

54.0074.01 25mm Ø x 64mm
54.0074.02 22mm Ø x 35mm

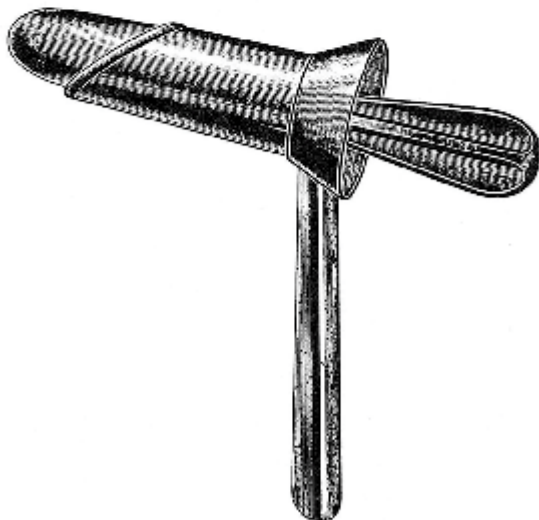

GRAEME-ANDERSON

54.0080.00 24mm Ø x 64mm

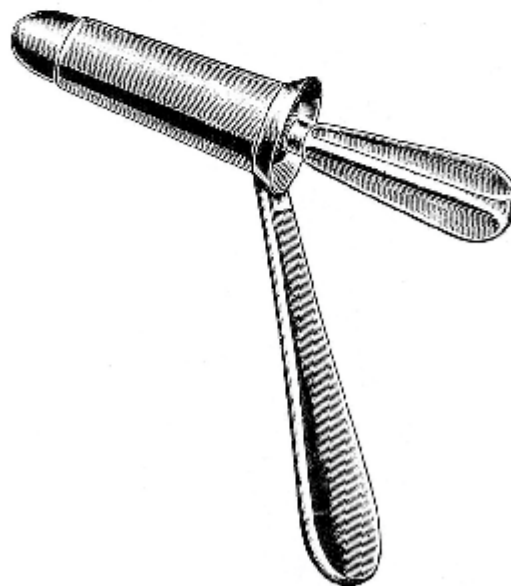

GABRIEL

54.0090.01 24mm Ø x 64mm
54.0090.02 19mm Ø x 49mm

Proctoscopes, Anoscope
 Proktoskope, Anoskop
 Proctoscopios y anoscopio
 Расширители ректальные
 肛门镜

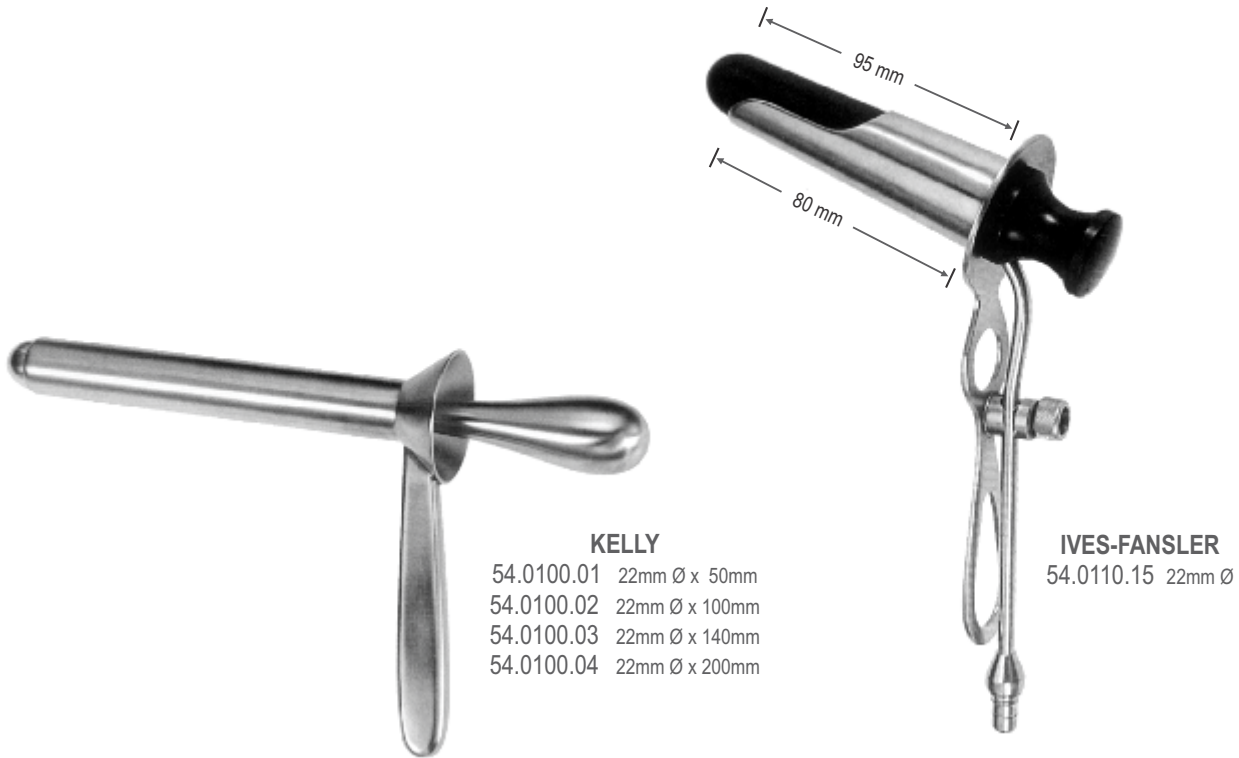

KELLY
 54.0100.01 22mm Ø x 50mm
 54.0100.02 22mm Ø x 100mm
 54.0100.03 22mm Ø x 140mm
 54.0100.04 22mm Ø x 200mm

IVES-FANSLER
 54.0110.15 22mm Ø

RECTUM



HIRSCHMANN
 54.0120.01 16mm Ø x 65mm
 54.0120.02 19mm Ø x 65mm
 54.0120.03 22mm Ø x 65mm

KELLY
 54.0130.01 22mm Ø x 50mm
 54.0130.02 22mm Ø x 100mm
 54.0130.03 22mm Ø x 140mm



MOD. MARTIN

54.0140.01 22mm Ø X 50mm
54.0140.02 22mm Ø X 75mm
54.0140.03 22mm Ø X 100mm



NEWMAN

54.0150.01 16mm Ø X 63mm
54.0150.02 19mm Ø X 63mm
54.0150.03 23mm Ø X 63mm



BENSAUDE

54.0160.01 19mmØ X 70mm
54.0160.02 22mmØ X 70mm

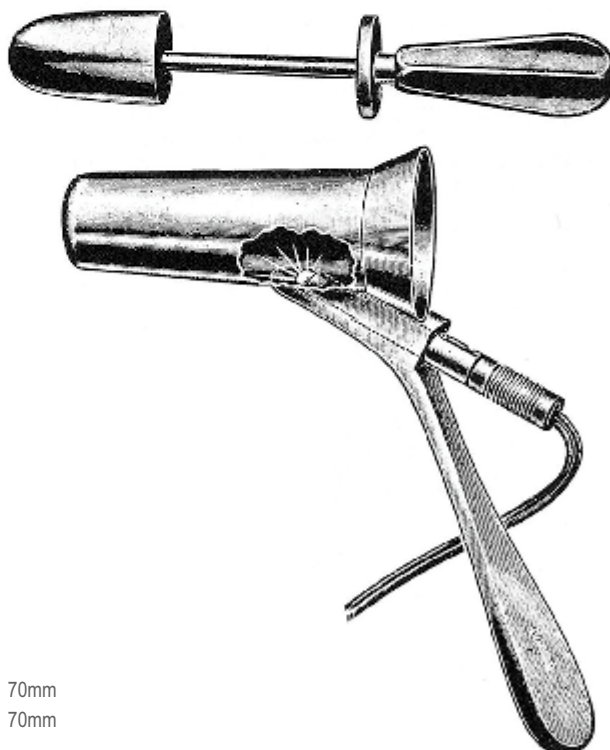

NAUNTON-MORGAN

54.0170.00 22mmØ X 70mm

Rectal Specula, Anal Retractors
 Mastdarm-Spekule,-Spreizer-Analspreizer
 Especulos rectales
 Расширители ректальные
 直肠镜廊，肛门拉钩



BARR
 54.0180.17 17.0cm

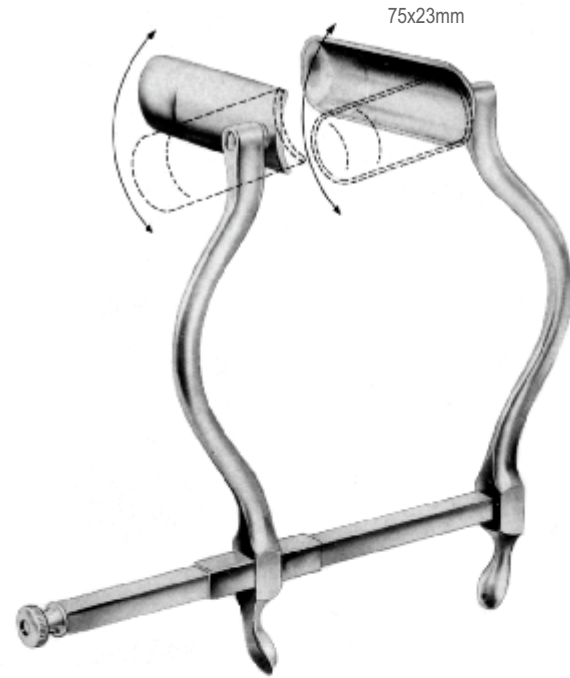

SMITH-BUIE
 54.0190.15 15.0cm

RECTUM



ALAN PARKS
 13.5cm

- 54.0200.00 complete
- 54.0200.04 centre blade
- 54.0200.13 frame only
- 54.0202.00 complete with fiberoptic attachment
- 54.0203.00 complete with f/o light and suction tube



54.0200.01
 72mm



54.0200.02
 90mm



54.0200.03
 94mm

Rectal Specula and Probes
 Mastdarm-Specula und Anal Sonden
 Espéculas rectales y sondas
 Зеркала ректальные, Зонды ректальные
 直肠镜和探头

RECTUM

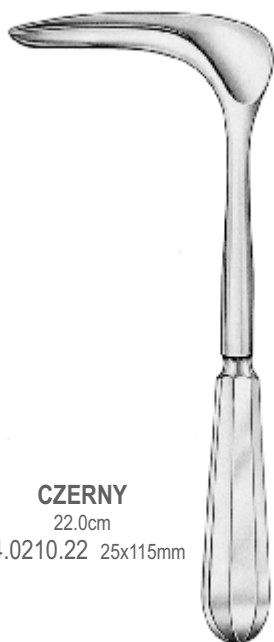

CZERNY
22.0cm
54.0210.22 25x115mm



SAWYER
23.0cm
54.0220.01 65x22mm
54.0220.02 75x28mm
54.0220.03 90x38mm



FERGUSON-MOON
21.0cm
54.0230.01 65x22mm
54.0230.02 75x28mm



BUIE 13.5cm
54.0240.13 light
54.0242.13 heavy



LARRY
54.0250.18
18.0cm



ROSER
54.0260.17
17.0cm



PRATT
22.0cm



54.0270.01



54.0270.02



54.0270.03



BARR
54.0280.23
23.0cm



BARR
54.0290.14
14.0cm



RECTUM

54.0300.01
 Fig.1 straight

54.0300.02
 Fig.2 45° curved

54.0300.03
 Fig.3 90° curved

54.0300.04
 Fig.4 retrograde curved

BRODIE 20.0cm

54.0310.20

LOCKHART-MUMMERY 16.5cm

Pelvis Retractors
Pelvishaken
Retradores de pelvis
Ретракторы для почечной лоханки
骨盆拉钩

RECTUM

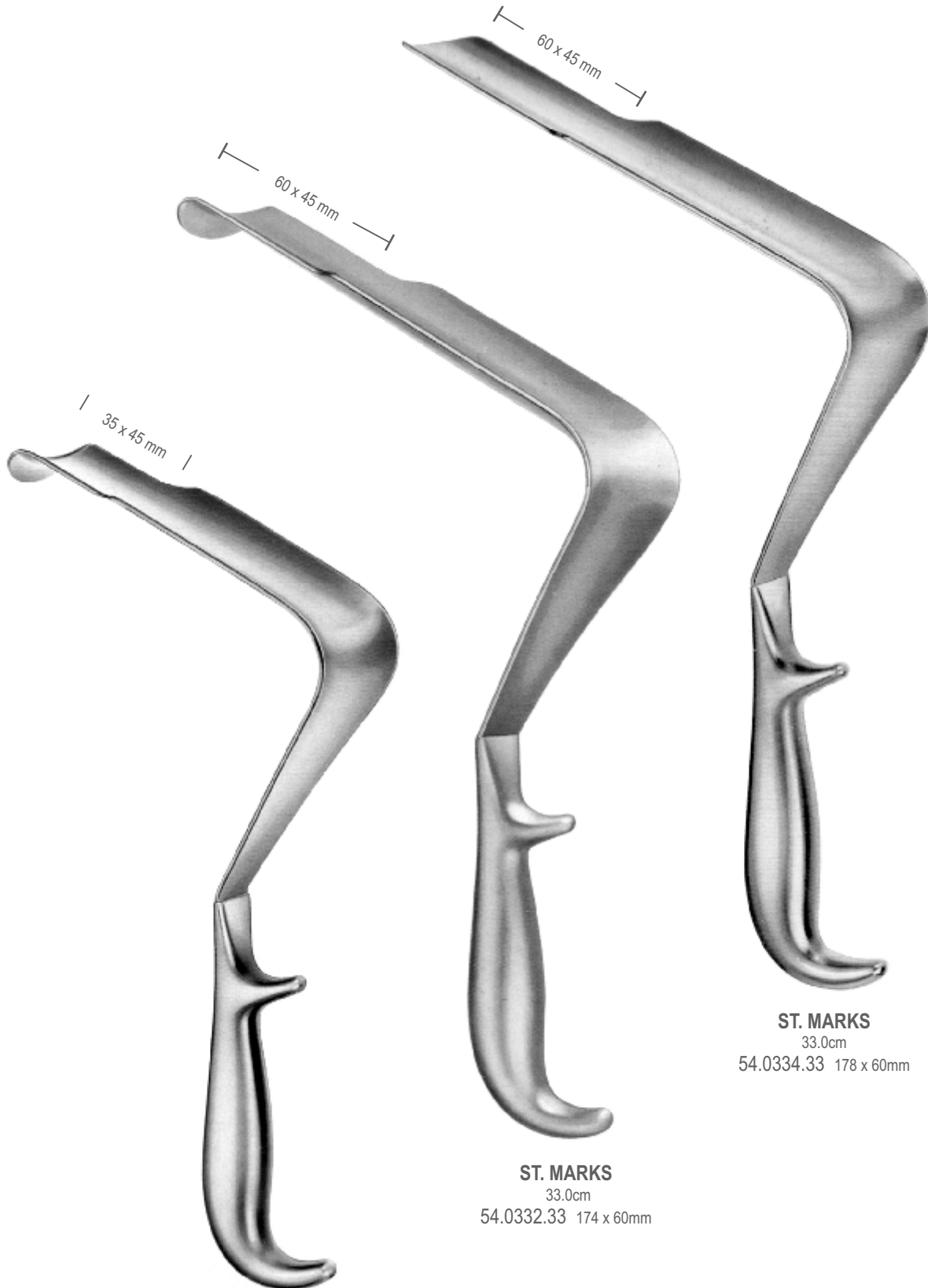

ST. MARKS
29.0cm
54.0330.29 124x60mm

ST. MARKS
33.0cm
54.0332.33 174 x 60mm

ST. MARKS
33.0cm
54.0334.33 178 x 60mm

Haemorrhoidal Ligator
 Hamorrhoidal-Ligator
 Hemorraidales ligaduras
 Зонды ректальные
 痔疮圈断器

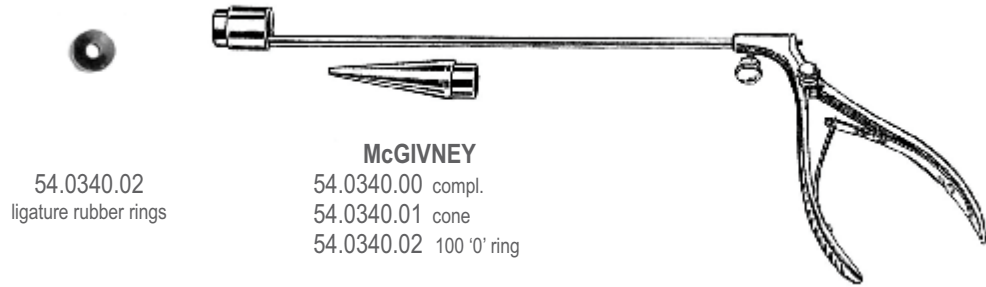

54.0340.02
 ligature rubber rings

McGIVNEY
 54.0340.00 compl.
 54.0340.01 cone
 54.0340.02 100 '0' ring

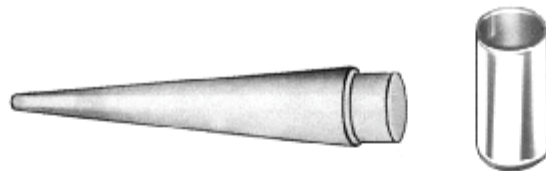

Loading Cone only
 54.0354.01

Suction Head
 54.0354.11 10x11mm
 54.0354.16 10x16mm

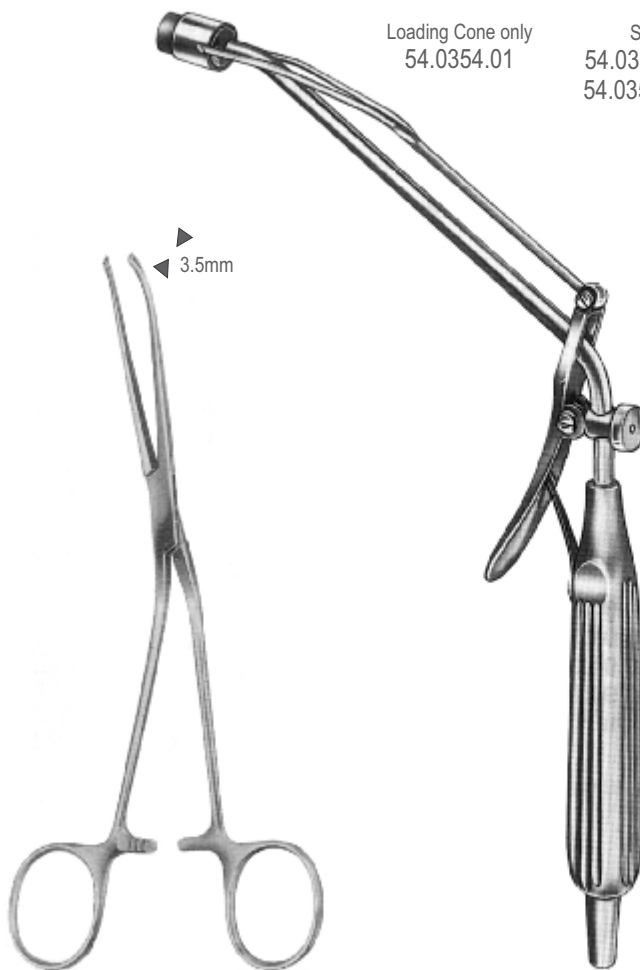

McGIVNEY
 54.0350.18 18.5cm



RUDD
 54.0360.31 31.5cm
 54.0360.01 cone
 54.0340.02 100 '0' ring

RECTUM

18.5cm
 54.0354.00 Set
 54.0354.01 Cone
 54.0354.11 Suction Head
 54.0354.16 Suction Head
 54.0340.02 100 '0' ring

Rectal Biopsy Specimen Forceps, Haemorrhoidal (Pile) Forceps
 Mastdarm-Biopsiezange, Hämorrhoidalzangen
 Pinza sacabocado para biopsia rectal, pinzas-clamps hemorroidales
 Щипцы геморроидальные
 直肠活检标本钳，痔（桩）钳子

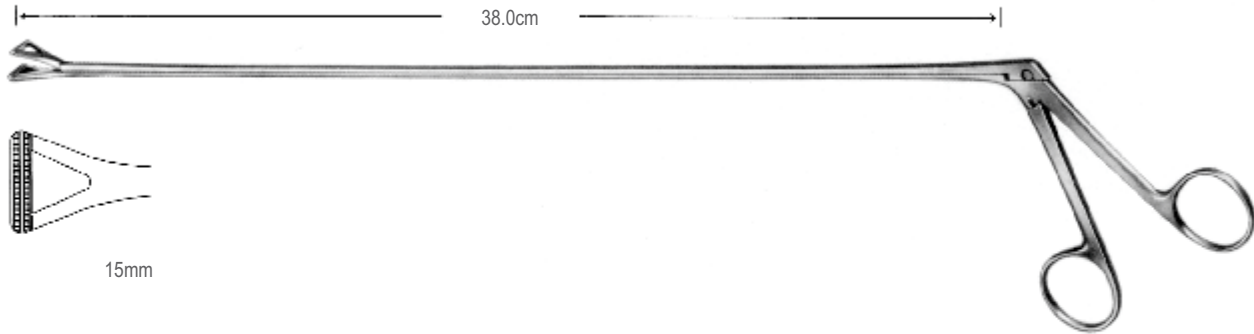

54.0370.38

RECTUM



HEYWOOD-SMITH
54.0380.21 21.0cm

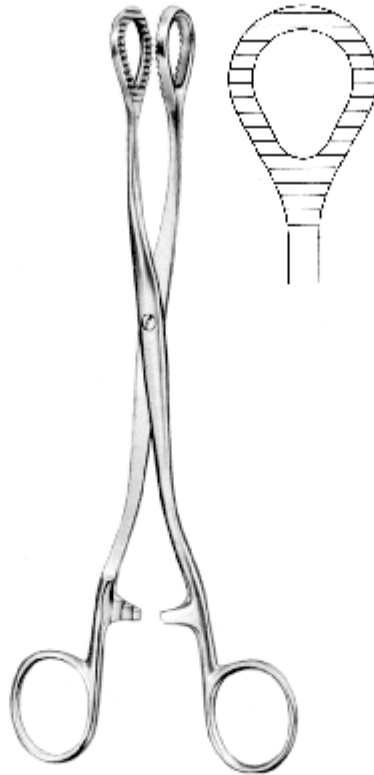
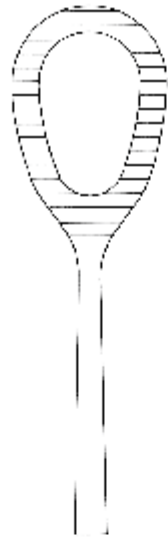

HEYWOOD-SMITH
54.0382.20 20.0cm

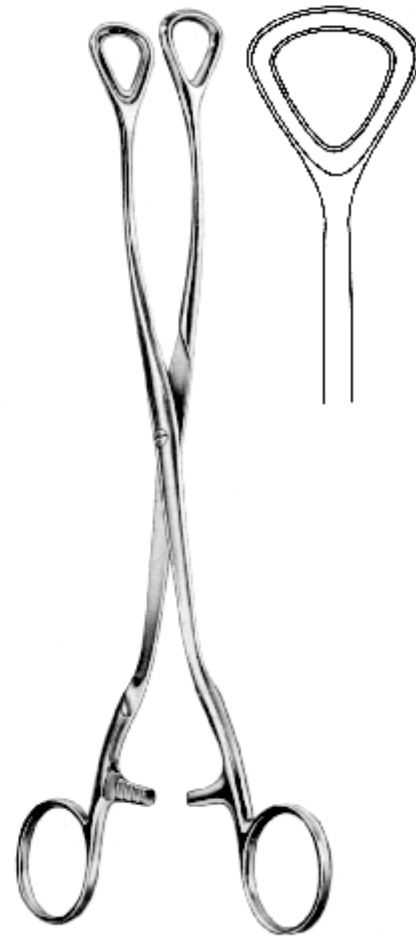
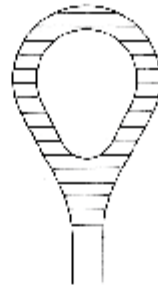

LUER
54.0390.24 24.5cm

Rectal Biopsy Forceps
 Mastdarm-Biopsiezange
 Pinzas sacabocado p / biopsia rectal
 Щипцы биопсийные
 直肠活检钳

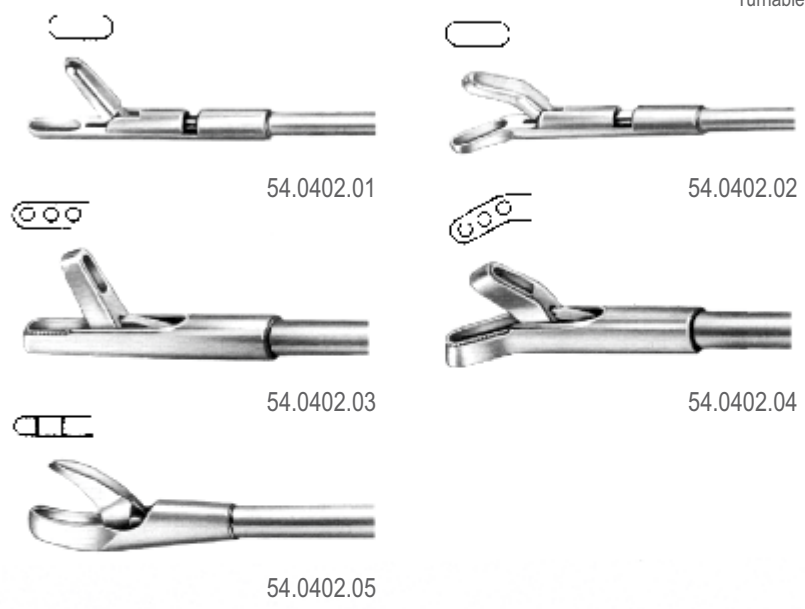
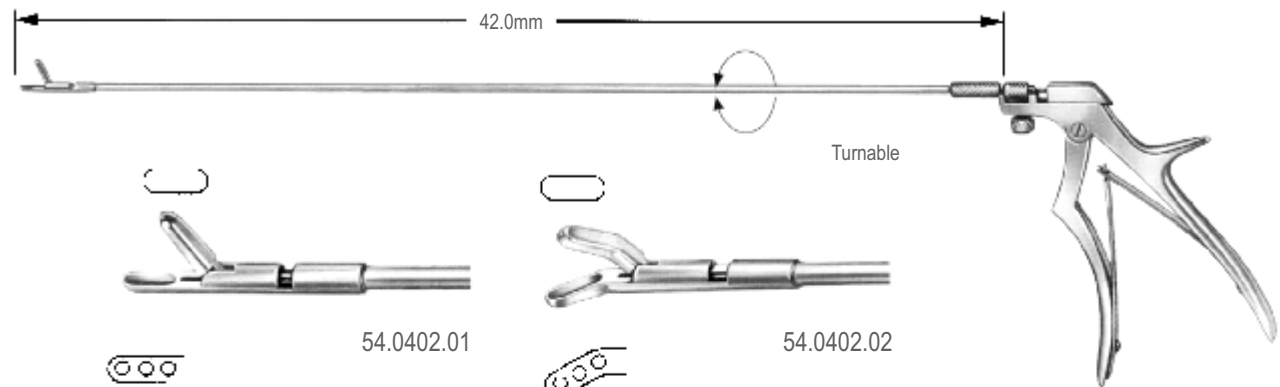

54.0400.00
Handle only

RECTUM

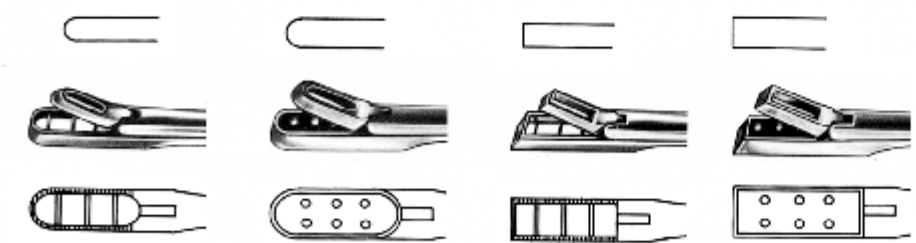
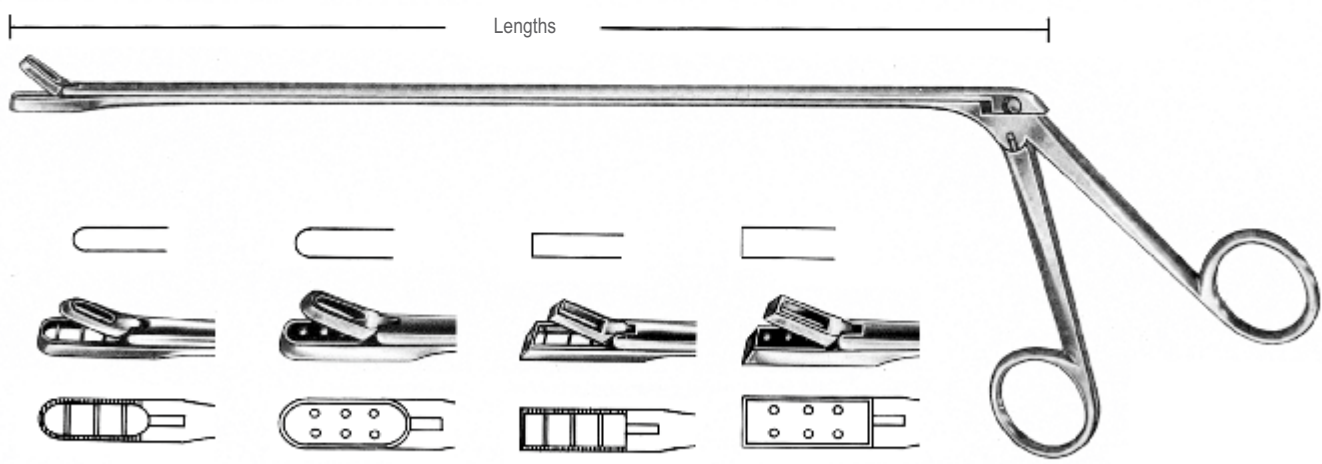

L/shaft	54.0410.28	54.0412.28	54.0414.28	54.0416.28
28.0cm	54.0410.28	54.0412.28	54.0414.28	54.0416.28
35.0cm	54.0410.35	54.0412.35	54.0414.35	54.0416.35
42.0cm	54.0410.42	54.0412.42	54.0414.42	54.0416.42

YEOMAN

Cotton Carrier For Rectoscope, Cotton Carriers
 Swattatrager Fur Rektoskope, Baumwollenboten
 Posta algodon para rectoscopios, portadores de algodón
 Зонды ректальные, Зонды ректальные (комплект)
 棉花载波的直肠镜，棉花运营商

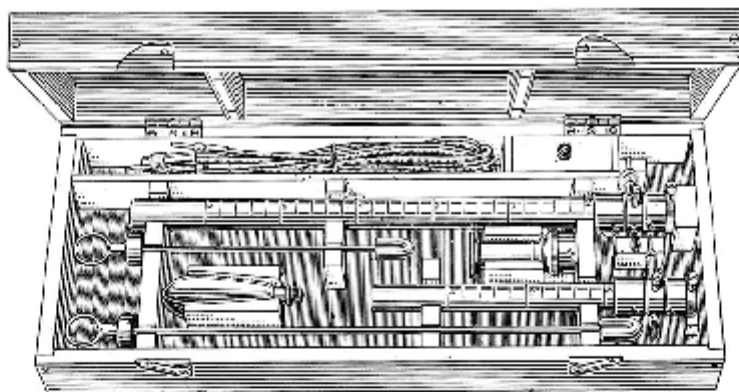

LLOYDS-DAVIES
54.0420.00 complete

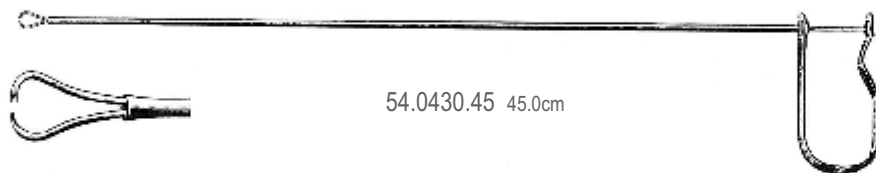

54.0430.45 45.0cm

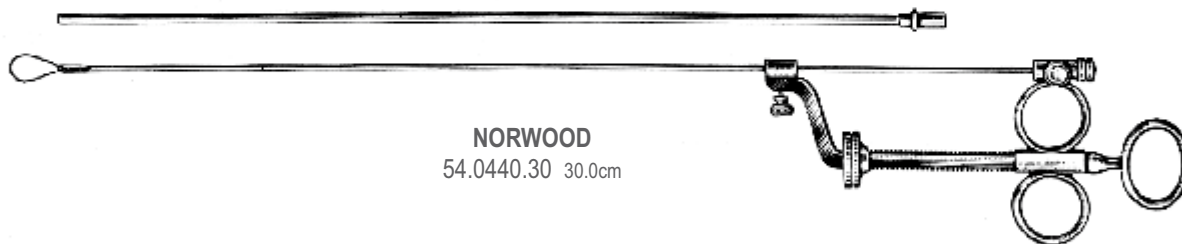

NORWOOD
54.0440.30 30.0cm

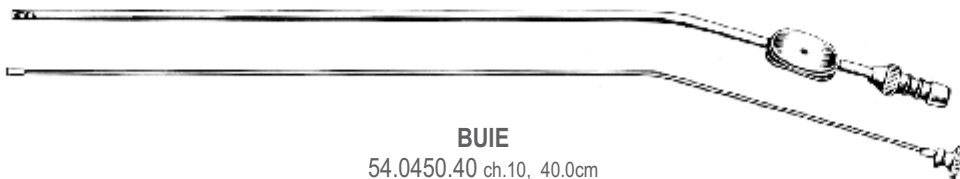

BUIE
54.0450.40 ch.10, 40.0cm

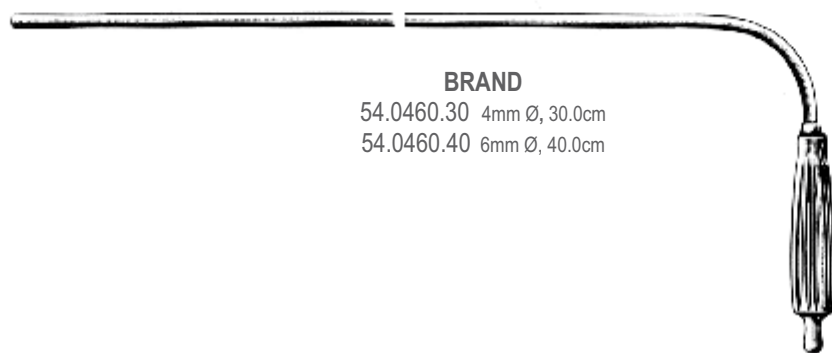

BRAND
54.0460.30 4mm Ø, 30.0cm
54.0460.40 6mm Ø, 40.0cm

RECTUM



SURGICAL
INSTRUMENTS



THE ULTIMATE CHOICE

Hilton
PREMIUM STAINLESS STEEL



THE ULTIMATE CHOICE

GALL BLADDER

Gall Bladder

Galle

Biliares

ИНСТРУМЕНТЫ ДЛЯ ОПЕРАЦИЙ НА ЖЕЛЧНОМ ПУЗЫРЕ

胆囊

56

001 - 010

Kidney Stone Forceps
Nierensteinzangen
Pinzas para calculos renales
Щипцы для почечных камней
肾取石钳

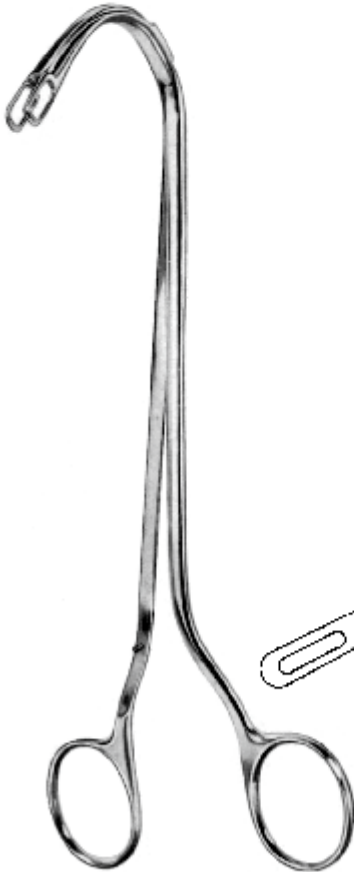

RANDALL
56.0010.01 - 56.0010.06

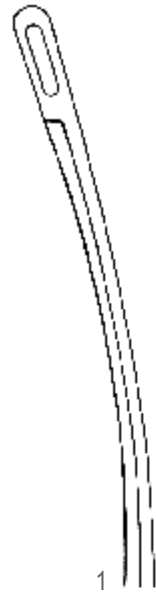

1
56.0010.01
23.0cm

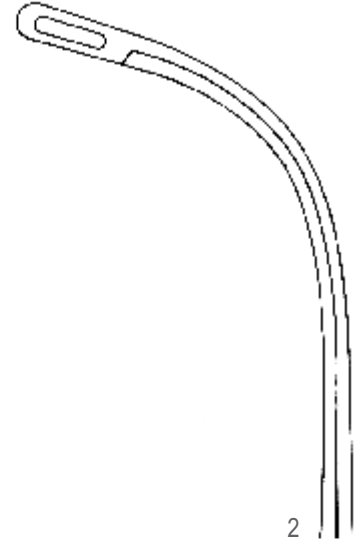

2
56.0010.02
22.0cm

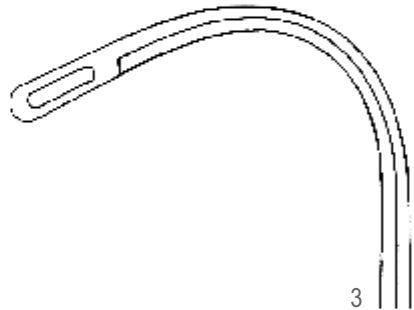

3
56.0010.03
22.0cm

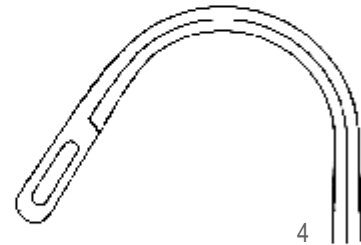

4
56.0010.04
22.0cm

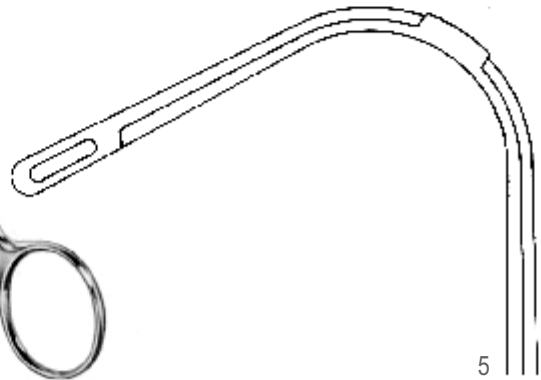

5
56.0010.05
19.0cm

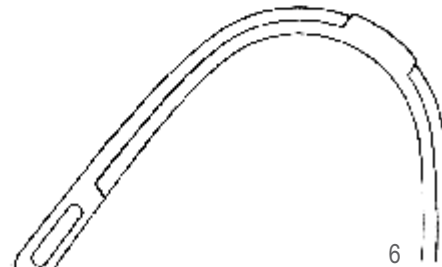

6
56.0010.06
19.0cm

GALL BLADDER

Gall Stone Forceps
Gallensteinzangen
Pinzas para cálculos biliares
Щипцы для почечных камней
胆取石钳

GALL BLADDER



TURNER-WARWICK
56.0020.18 18.0cm



TURNER-WARWICK
56.0022.19 19.0cm

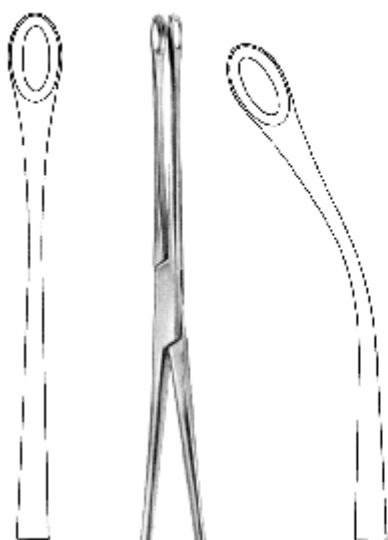

56.0030.20



56.0031.20

BLAKE
20.0cm



MAYO-BLAKE
56.0040.20 20.0cm



MAYO-BLAKE
56.0041.20 20.0cm

Gall Stone Forceps and Scoops
Gallensteinzangen und Gallensteinfänger
Pinzas, cucharillas y biliares
Щипцы для почечных камней
胆取石钳和勺



MIXTER
56.0050.22 22.0cm



DESJARDINS
23.0cm



CZERNY
56.0070.24 24.5cm

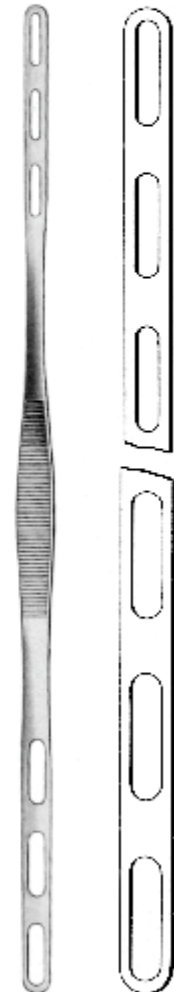

56.0080.26 26.5cm
malleable

GALL BLADDER

GALL BLADDER

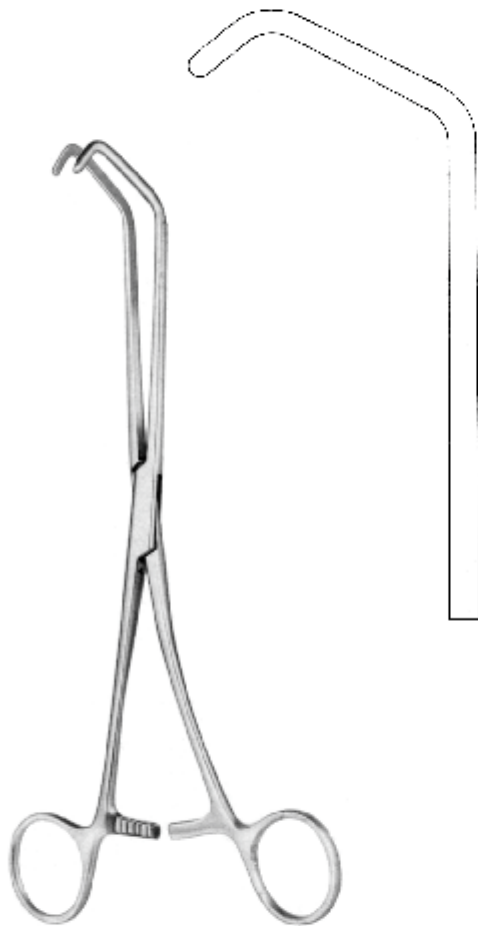

LURZ
56.0090.21 21.0cm



LURZ
56.0092.21 21.0cm

Catheter Introducers, Kidney Forceps
Katheterfuhrer, Nierenfazzangen
Introdutor de cateteres, pinzas para rinon
Щипцы для почечных камней
导管导引, 肾钳

Hilton
PREMIUM STAINLESS STEEL



HIRTH
56.0100.18 18.0cm

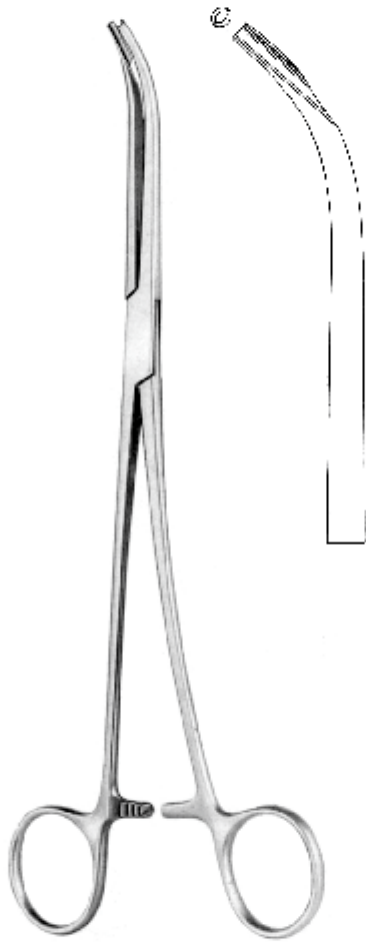

SÖKELAND
56.0106.24 24.0cm



KOCHER
56.0110.26 26.0cm

GALL BLADDER

GALL BLADDER



ELSÄSSER
56.0120.20 20.0cm



ELSÄSSER
56.0122.20 20.0cm

Gall Duct Dilators
Gallenkanal Dilatoren
Dilatadores para conductos biliares
Расширители для желчных протоков
胆囊管扩张器



56.0130.01
1mm Ø



56.0130.02
2mm Ø



56.0130.03
3mm Ø



56.0130.04
4mm Ø



56.0130.05
5mm Ø



56.0130.06
6mm Ø



56.0130.07
7mm Ø



56.0130.08
8mm Ø



56.0130.09
9mm Ø



56.0130.10
10mm Ø



56.0130.11
11mm Ø



56.0130.12
12mm Ø



56.0130.13
13mm Ø

GALL BLADDER

BAKES

56.0130.00 set / 13

56.0132.00 set / 9 (3-11)

56

56-007

GALL BLADDER



MAYO
56.0150.32 32.0cm

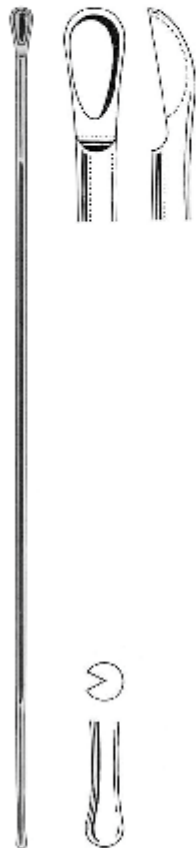

MOYNIHAN
56.0156.34 34.0cm
malleable



DESJARDINS
28.0cm

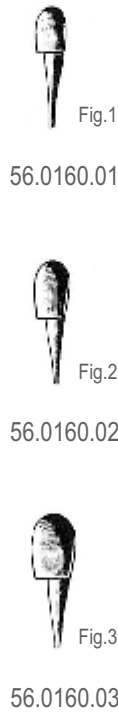

Fig.1
56.0160.01
Fig.2
56.0160.02
Fig.3
56.0160.03



DESJARDINS
28.0cm
elastic



Fig.1
56.0162.01
Fig.2
56.0162.02
Fig.3
56.0162.03



DESJARDINS
30.0cm
elastic



Fig.1
56.0166.01
Fig.2
56.0166.02
Fig.3
56.0166.03
Fig.4
56.0166.04

Gall Stone Scoops
 Gallensteinloffel
 Cucharillas para coger calculos biliares
 Ложки для желчных камней
 胆道刮匙

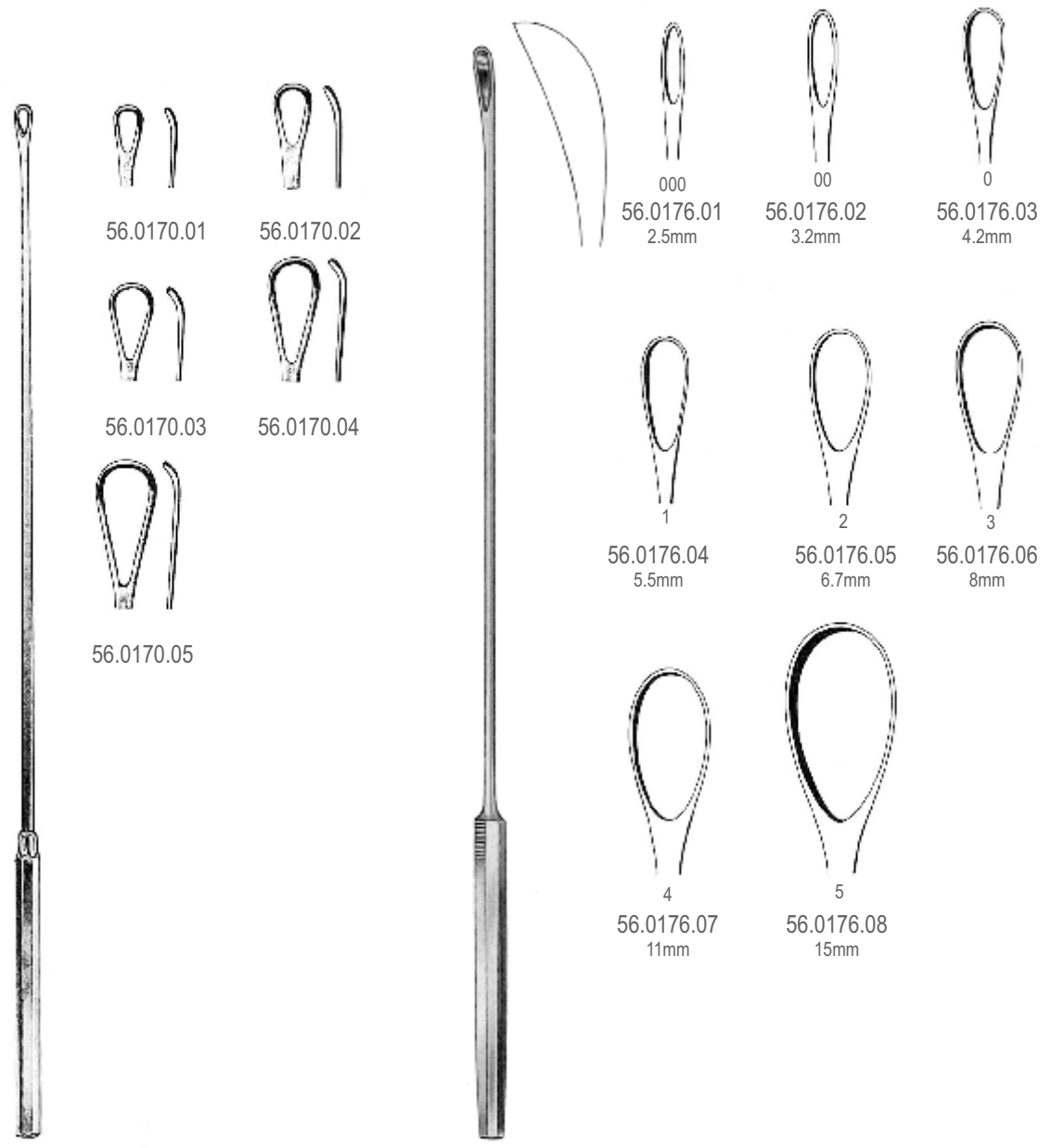

MUENCHEN MODEL
30.0cm

LUER-KOERTE
32.0cm
malleable

GALL BLADDER



Gall Stone Scoops
Gallensteinlöffel
Cucharillas para coger calculos
Ложки для желчных камней
胆道刮匙

GALL BLADDER



MAYO

56.0180.28 28.0cm



56.0186.34 34.0cm



FERGUSSON



56.0190.21
21.5cm

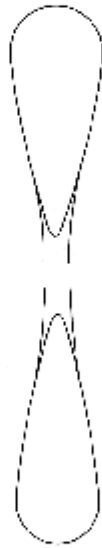

56.0190.22
22.0cm

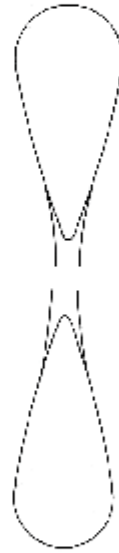

56.0190.23
23.5cm



MOORE

56.0196.28 28.0cm



SURGICAL
INSTRUMENTS



THE ULTIMATE CHOICE

Hilton
PREMIUM STAINLESS STEEL



THE ULTIMATE CHOICE

UROLOGY

Urology
Urologie
Urologia
УРОЛОГИЯ
泌尿科学

58

001 - 013

Prostatic Retractors
Prostathaken
Separadores para la prostata
Ретракторы урологические
前列腺拉钩



YOUNG
58.0010.22 22.0cm



YOUNG
58.0012.21 21.0cm



YOUNG
58.0014.22 22.0cm

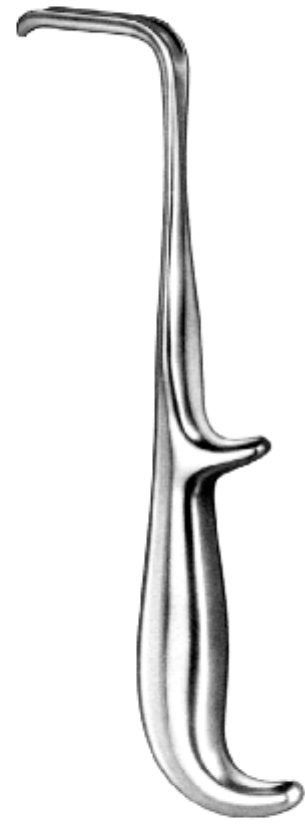

YOUNG
58.0016.21 21.0cm

UROLOGY



KOCHER
58.0020.26 26.0cm



LEGUEU
58.0024.27 27.0cm

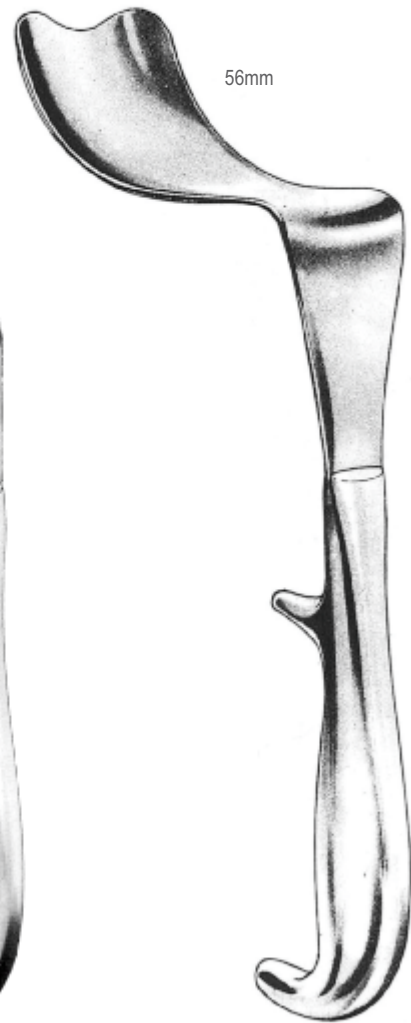

KOCHER
58.0028.26 26.0cm

Bladder Retractors
Blasen-Wundspreizer
Separadores vesicales
Расширители для мочевого пузыря
膀胱牵开器

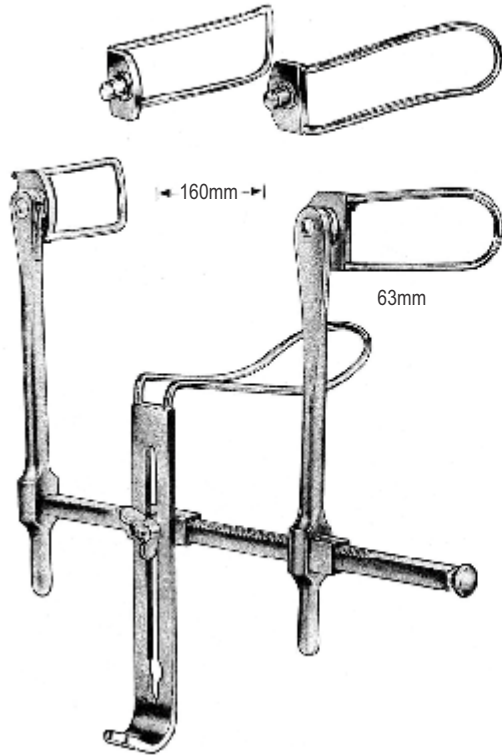

GOSSET
58.0040.00



THOMSON-WALKER
58.0050.00

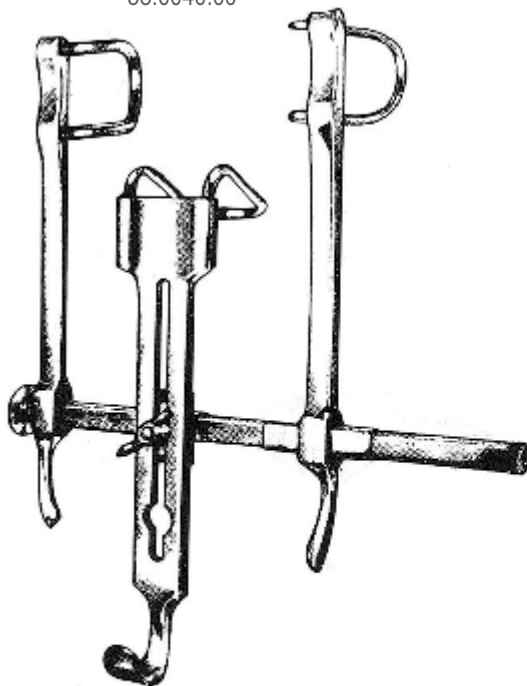

PANTINGS
58.0060.00



JUDD-MASSON
58.0064.00

UROLOGY



LEGUEU
58.0070.00



MILLIN
58.0074.00



MILLIN
58.0080.00

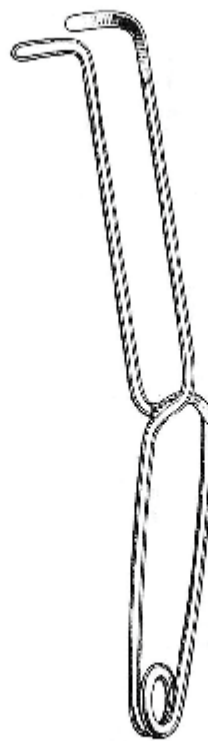

MILLIN
58.0082.00



MILLIN
58.0084.00

Prostectomy Forceps
Klemmen für Prostata-Operationen
Pinzas para prostatectomia
Зажимы урологические
前列腺切除钳钳

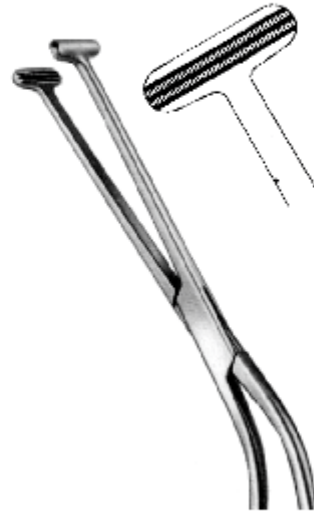

58.0092.23 23.5cm

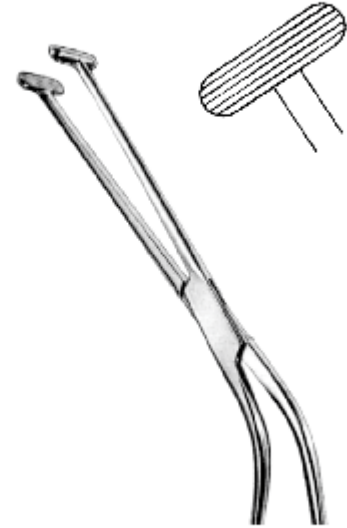

58.0094.23 23.0cm



MILLIN
58.0090.24 24.5cm



58.0096.23 23.0cm

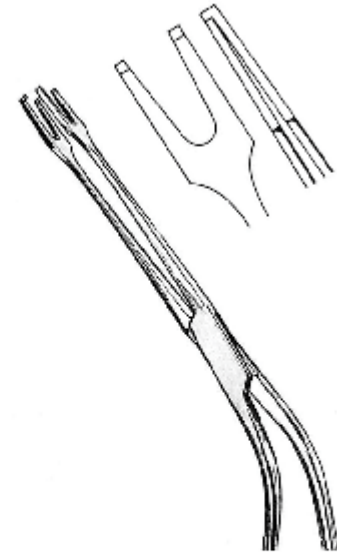

58.0098.24 24.0cm

UROLOGY

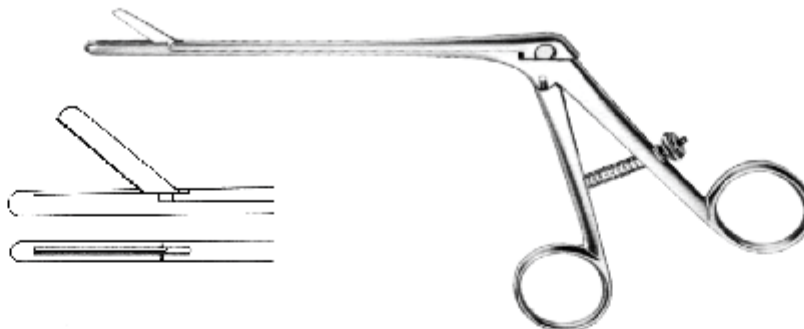

SACHSE
58.0110.12

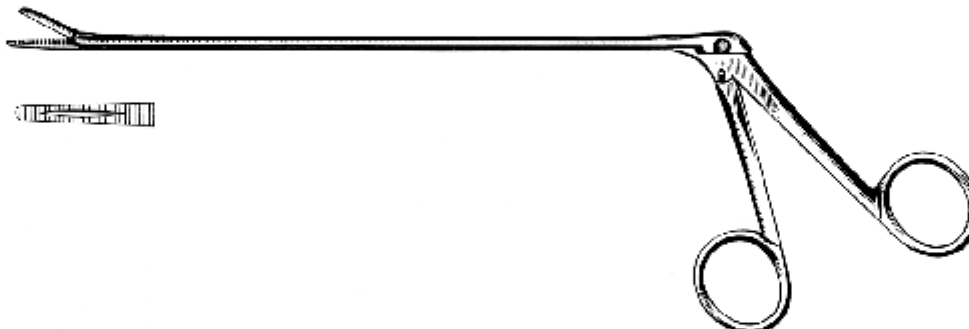

MATHIEU
58.0114.20 20.0cm
58.0114.28 28.0cm

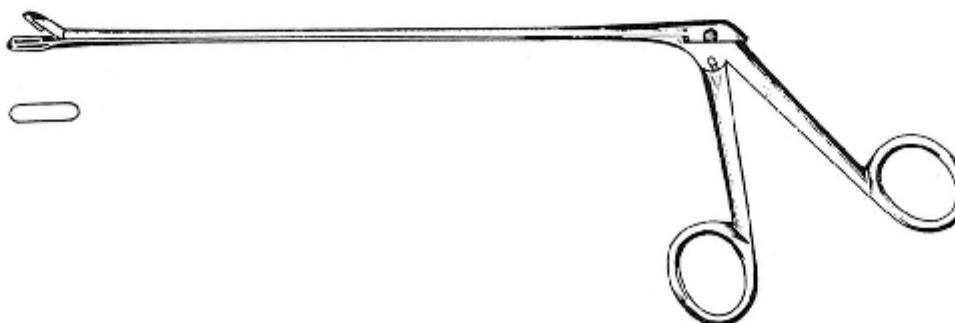

MATHIEU
58.0120.20 20.0cm
58.0120.28 28.0cm

Penis Clamp and Lithotomy Forceps
 Penisklemmen und Steinzgen
 Compresores uretrales y pinzas p/litomia
 Зажимы для полового члена, Зажимы урологические
 阴茎钳和镊子截石



STOCKMANN
58.0130.08



ZIESER MEATUS CLAMP
58.0132.10 10.0cm



STRAUSS
58.0134.11



THOMSON-WALKER
58.0136.00



LEWKOWITZ
58.0140.26 26.0cm



58.0141.26



YOUNG
58.0146.20 20.0cm

UROLOGY



GAMCO

- 58.0150.08 8mm Ø, baby size
- 58.0150.11 11mm Ø, child size
- 58.0150.13 13mm Ø, child size
- 58.0150.16 16mm Ø, adolescent size
- 58.0150.21 21mm Ø, adolescent size
- 58.0150.26 26mm Ø, men's size
- 58.0150.32 32mm Ø, men's size



WINKELMANN

- 58.0156.12 12mm Ø
- 58.0156.16 16mm Ø
- 58.0156.20 20mm Ø

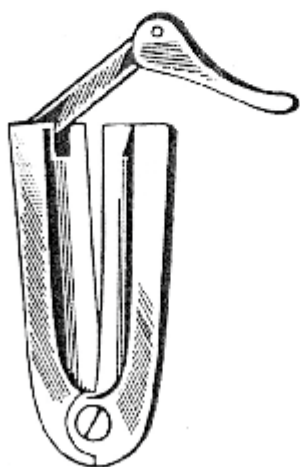

MOGEN

- 58.0160.00 adult
- 58.0162.00 child

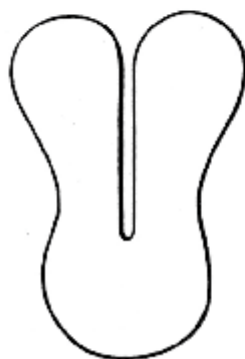

CIRCUMCISION SHIELD

- 58.0164.10 10.0cm



CIRCUMCISION PROBE

- 58.0168.15 15.0cm

Hernia Directors, Suction Tube, Cord Hook
 Sonden, Aspirationskanulen, Haken für den sanenstrang
 Sondas, canulas de aspiracion, ganchol/el cordon
 Зонды урологические, Трубки урологические
 疝气董事, 吸料管, 线钩



CHILD
58.0180.00



KEY
58.0186.00

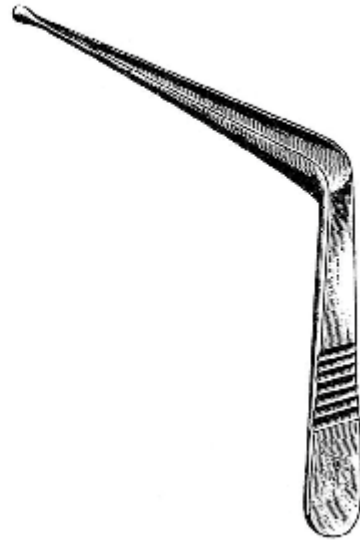

TEALE
58.0190.00

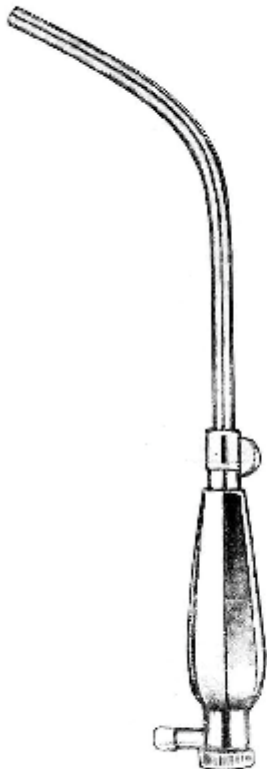

MILLIN
58.0194.00

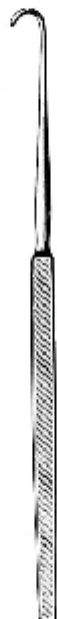

CORD HOOK
58.0200.16 16.0cm



GUTTMANN
58.0204.26 26.0cm

UROLOGY

UROLOGY

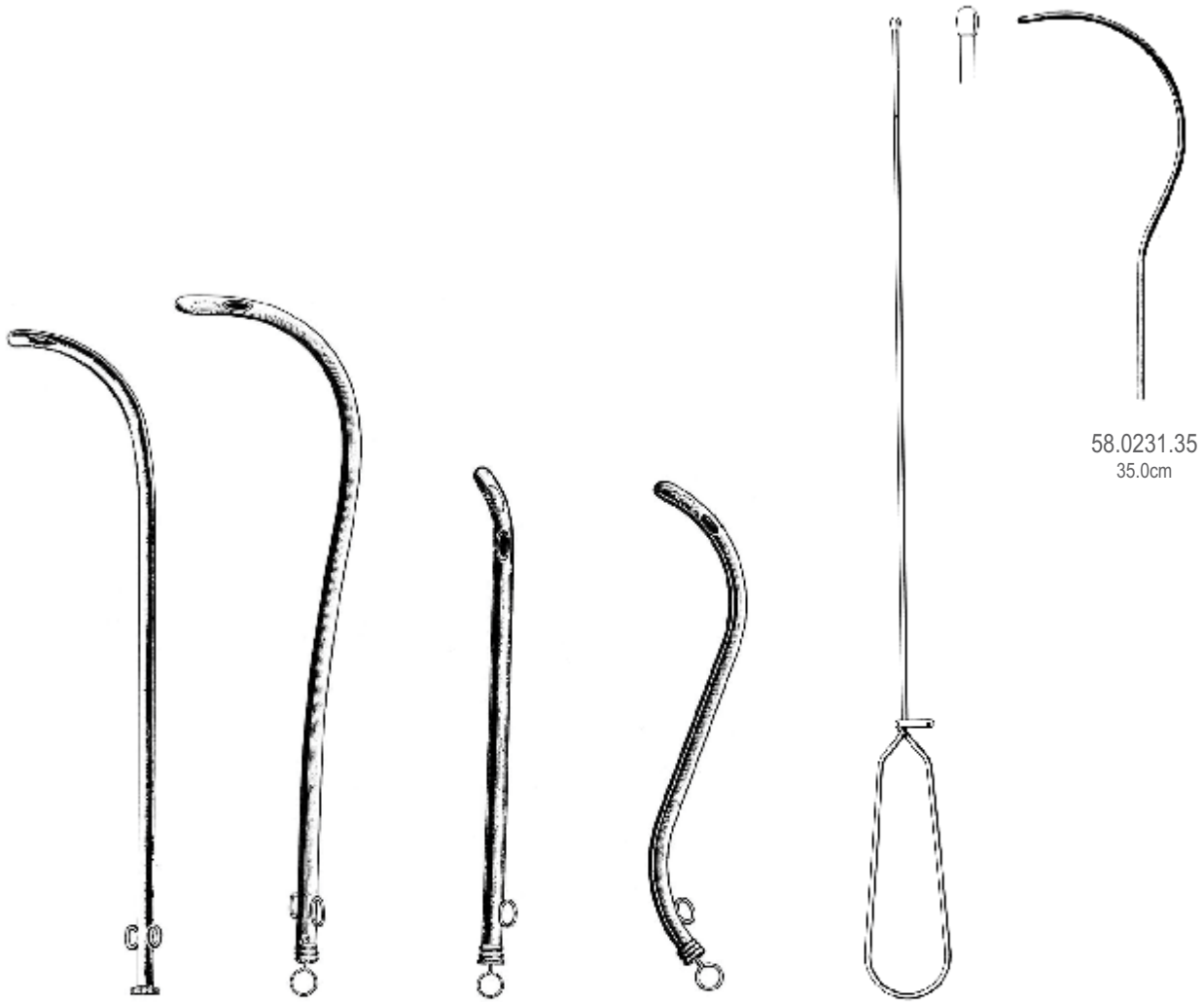

COXETER

F.G.	MALE 27.0cm	28.0cm	FEMALE 15.0cm	MALE 20.0cm
6	58.0210.06	58.0216.06	58.0220.06	58.0226.06
8	58.0210.08	58.0216.08	58.0220.08	58.0226.08
10	58.0210.10	58.0216.10	58.0220.10	58.0226.10
12	58.0210.12	58.0216.12	58.0220.12	58.0226.12
14	58.0210.14	58.0216.14	58.0220.14	58.0226.14
16	58.0210.16	58.0216.16	58.0220.16	58.0226.16
18	58.0210.18	58.0216.18	58.0220.18	58.0226.18
20	58.0210.20	58.0216.20	58.0220.20	58.0226.20
22	58.0210.22	58.0216.22	58.0220.22	58.0226.22
24	58.0210.24	58.0216.24	58.0220.24	58.0226.24

58.0230.39
39.0cm

Dilating Bougies
 Dilationsbougies
 Bujias Diladoras
 Бужи
 尿道扩张器



UROLOGY

CLUTTON

set	58.0236.00
F.G.	
06/10	58.0236.06
08/12	58.0236.08
10/14	58.0236.10
12/16	58.0236.12
14/18	58.0236.14
16/20	58.0236.16
18/22	58.0236.18
20/24	58.0236.20
22/26	58.0236.22
24/28	58.0236.24
26/30	58.0236.26
28/32	58.0236.28

LISTER

set	58.0240.00
F.G.	
00/1	58.0240.01
0/2	58.0240.02
1/3	58.0240.03
1/4	58.0240.04
2/5	58.0240.05
3/6	58.0240.06
4/7	58.0240.07
5/8	58.0240.08
6/9	58.0240.09
7/10	58.0240.10
8/11	58.0240.11
9/12	58.0240.12
10/13	58.0240.13
11/14	58.0240.14
12/15	58.0240.15
13/16	58.0240.16
14/17	58.0240.17
15/18	58.0240.18

F.G.

06	58.0246.06
08	58.0246.08
10	58.0246.10
12	58.0246.12
14	58.0246.14
16	58.0246.16

WHEELHOUSE

58.0250.00

Dilating Bougies
Dilationsbougies
Bujas dilatadoras
Расширители урологические, Бужи
尿道扩张器



UROLOGY

	VAN BUREN	GUYON	GUYON	DITTEL	DITTEL
	58.0260.00 set No. 8-36	58.0270.00 set No. 10-30	58.0272.00 set No. 10-30	58.0280.00 set No.10-30	58.0282.00 set No.8-30
(French)					
8	58.0260.08				58.0282.08
9					58.0282.09
10	58.0260.10	58.0270.10	58.0272.10	58.0280.10	58.0282.10
11		58.0270.11	58.0272.11	58.0280.11	58.0282.11
12	58.0260.12	58.0270.12	58.0272.12	58.0280.12	58.0282.12
13		58.0270.13	58.0272.13	58.0280.13	58.0282.13
14	58.0260.14	58.0270.14	58.0272.14	58.0280.14	58.0282.14
15		58.0270.15	58.0272.15	58.0280.15	58.0282.15
16	58.0260.16	58.0270.16	58.0272.16	58.0280.16	58.0282.16
17		58.0270.17	58.0272.17	58.0280.17	58.0282.17
18	58.0260.18	58.0270.18	58.0272.18	58.0280.18	58.0282.18
19		58.0270.19	58.0272.19	58.0280.19	58.0282.19
20	58.0260.20	58.0270.20	58.0272.20	58.0280.20	58.0282.20
21		58.0270.21	58.0272.21	58.0280.21	58.0282.21
22	58.0260.22	58.0270.22	58.0272.22	58.0280.22	58.0282.22
23		58.0270.23	58.0272.23	58.0280.23	58.0282.23
24	58.0260.24	58.0270.24	58.0272.24	58.0280.24	58.0282.24
25		58.0270.25	58.0272.25	58.0280.25	58.0282.25
26	58.0260.26	58.0270.26	58.0272.26	58.0280.26	58.0282.26
27		58.0270.27	58.0272.27	58.0280.27	58.0282.27
28	58.0260.28	58.0270.28	58.0272.28	58.0280.28	58.0282.28
29		58.0270.29	58.0272.29	58.0280.29	58.0282.29
30	58.0260.30	58.0270.30	58.0272.30	58.0280.30	58.0282.30
31	58.0260.31				
32	58.0260.32				
33	58.0260.33				
34	58.0260.34				
35	58.0260.35				
36	58.0260.36				

Set of Dilating Sounds
Dilatationsbesteck
Juego de bujias dilatadoras
Расширители урологические, Расширители урологические (комплекты)
尿道扩张器

Hilton
PREMIUM STAINLESS STEEL

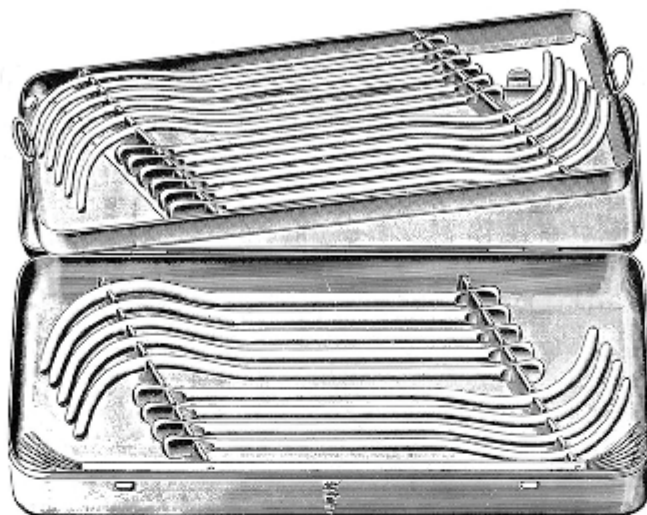

VAN BUREN
58.0290.00
420x175x40 mm
set in metal case containing
29 bougies



GUYON
58.0291.00
420x175x40mm
set in metal case containing
21 bougies
6 liliform in metal tube

UROLOGY

58
58-013



SURGICAL
INSTRUMENTS



THE ULTIMATE CHOICE

Hilton
PREMIUM STAINLESS STEEL



THE ULTIMATE CHOICE

STERILIZATION

Sterilization
Sterilisation
Esterilización
СТЕРИЛИЗАЦИЯ
消毒

64

001 - 002

Sterilizing Forceps
 Sterilisierzangen
 Pinzas para esterilizacion
 Зажимы специальные для стерилизации
 消毒钳、器械钳



CHEATLE
 64.0010.27 27.0cm

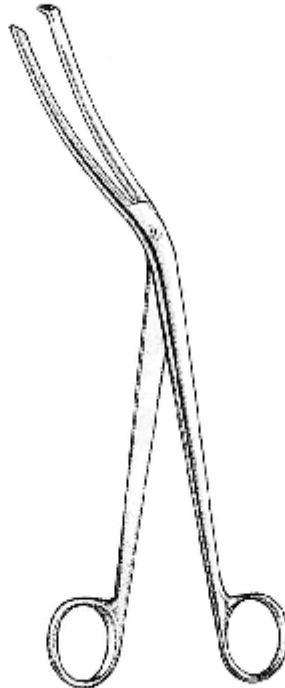

CHEATLE
 64.0012.27 26.5cm



CHEATLE
 64.0020.28 28.0cm



64.0030.20 20.0cm
 64.0030.30 30.0cm

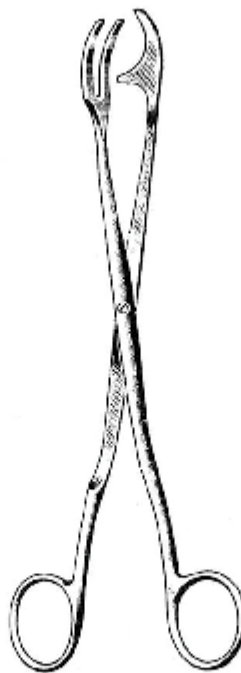

ROGGE
 64.0040.23 23.0cm



DAVIS
 64.0050.16 16.0cm
 64.0050.20 20.0cm
 64.0050.24 24.0cm

STERILIZATION



UNIVERSAL
64.0060.20 20.0cm
64.0060.28 28.0cm

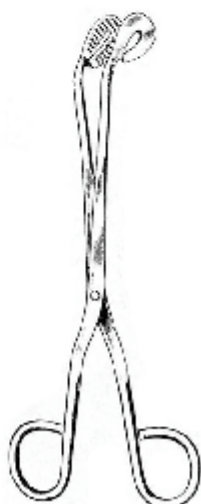

UNIVERSAL
64.0061.20 20.0cm
64.0061.28 28.0cm



PYE-SMITH (HARRISON)
64.0070.25 25.0cm
64.0070.30 30.0cm

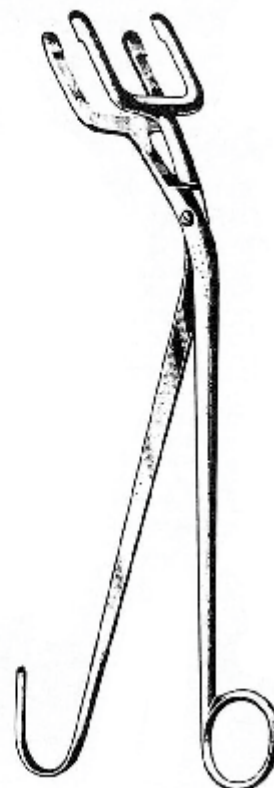

HARRISON
64.0080.25 25.0cm
64.0080.30 30.0cm
64.0080.35 35.0cm
64.0080.45 45.0cm

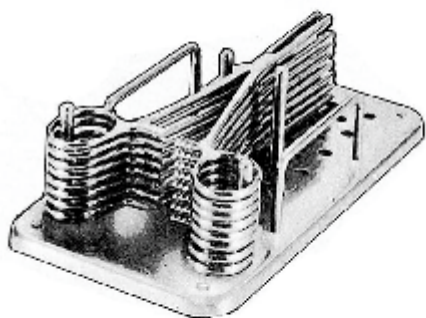

64.0090.00



BUNT
64.0100.12 12.0cm



MAYO
64.0104.10 10.0cm
64.0104.12 12.0cm
64.0104.14 14.0cm
64.0104.15 15.0cm



MAYO
64.0106.14 14.0cm



THE ULTIMATE CHOICE

ASEPSIS

Asepsis
Keimfreiheit
Asepsia
АСЕПТИКА
无菌

66

001 - 002

Cuticle Scissors, Cuticle Nippers, Nail Files
 Hautscheren, Nagelhautzangen, Nagelfeilen
 Pinzas y tijeras cuticulares, limas para unas
 Ножницы для кутикулы, Кусачки для ногтей, Пилки для ногтей
 角质层剪刀, 钳子角质层, 指甲锉

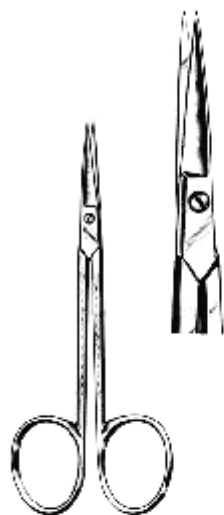

66.0010.10 10.5cm

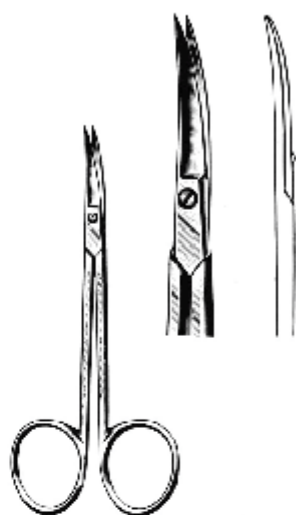

66.0011.10 10.5cm



66.0020.10 10.5cm

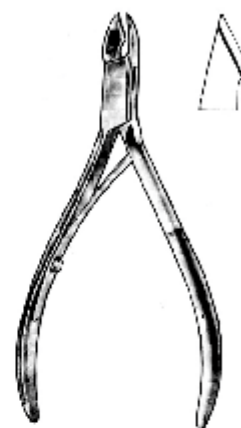

66.0030.10 10.5cm
 66.0030.11 11.5cm
 66.0030.13 13.0cm



66.0040.11 11.0cm
 66.0040.13 13.0cm
 66.0040.15 15.0cm

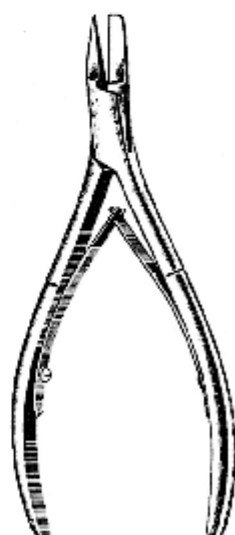

INGROWN TOE NAIL FORCEPS
English (Anvil) Pattern
 66.0050.12 12.5cm



66.0060.10 10.0cm
 66.0060.12 12.0cm



66.0070.16 16.0cm

ASEPSIS

Nail Scissors, Nippers
Nagelscheren, Nagelzangen
Tijeras para unhas, pinzas corta-unhas
Ножницы для кутикулы, Кусачки для ногтей
指甲剪, 钳

ASEPSIS



66.0080.09	9.0cm	66.0081.09
66.0080.10	10.0cm	66.0081.10
66.0080.11	11.0cm	66.0081.11



66.0090.12	12.0cm
66.0090.13	13.0cm

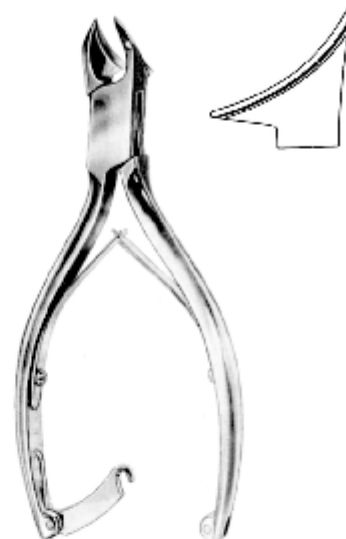

66.0100.14	14.0cm
------------	--------

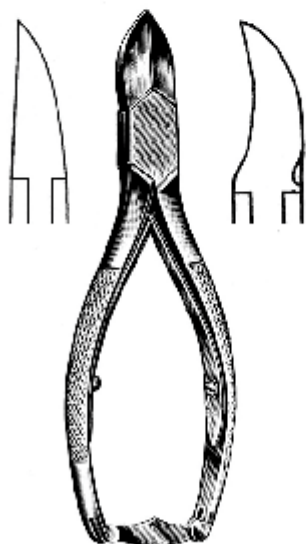

66.0110.14	14.0cm
66.0110.16	16.0cm

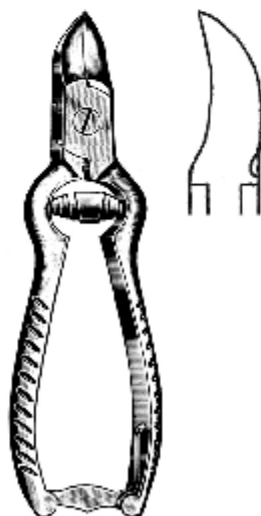

TURNBULL
66.0120.11 11.0cm
66.0120.13 13.0cm



NAIL NIPPER
double action
66.0130.15 15.0cm

